

### PART NUMBERS

Table 1

VERTICAL CABLE MANAGEMENT		Mounting Kits (sold separately)	Racks	Doors
Front/Rear	Front Only	WMPVCBE, NRVCB (Center Mount)	R2P Series of Racks R4P Series of Racks ER4P Series of Racks	WMPV Includes Cover
WMPV22E	WMPVF22E	(Standard mounting for Panduit 2 and 4 post racks		
WMPV45E	WMPVF45E	racks. One kit Included.)		
WMPVHC45E	WMPVHCF45E			
NRV6	NRVF6	WMPVSMK (Side Mount)	R2P Series of Racks	NRD6B1
NRV10	NRVF10	(Optional Mounting for 4 post racks and R2PS)	R4P Series of Racks	NRD10B1
NRV12	NRVF12	(Required Mounting for R2P6S)		NRD12B1

### Location Guide for Center Mounting (R2P with WMPVCBE and NRVCB)

Dimensions in ( ) parenthesis are for 6" Vertical Cable Management

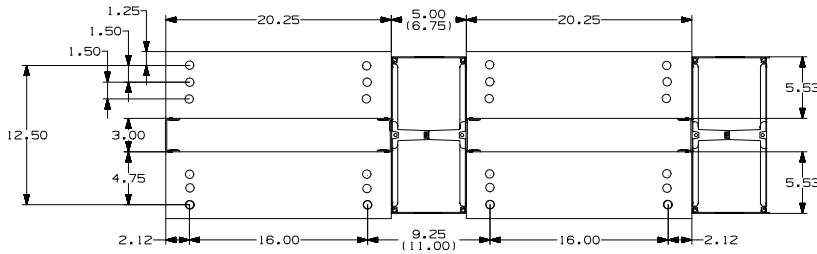

### Bracket Installation

1

**Note:**  
For additional brackets when installing between two racks use part number **WMPVCBE** or **NRVCB**. Bracket is keyed to be installed in the correct orientation.

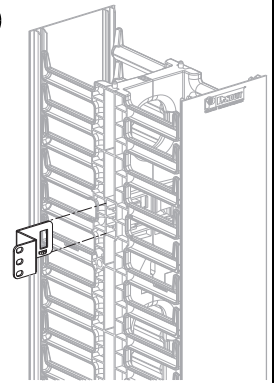

### Standard Rack Installation

2

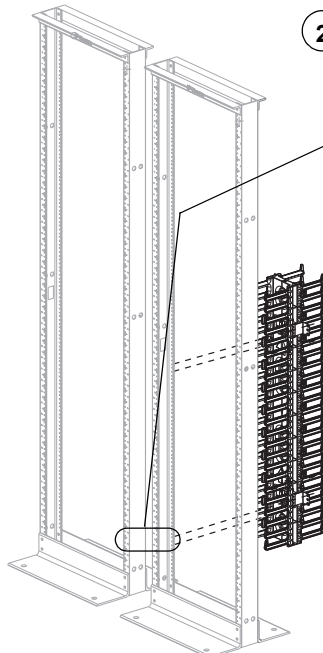

Bottom Mounting Location

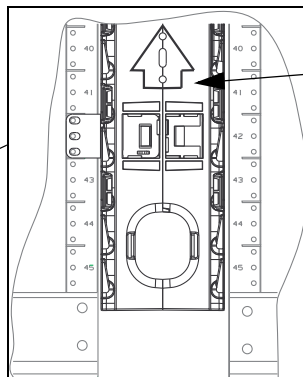

Rear Bottom Mounting Location

**Note:**  
Arrows and flags must point upward

4

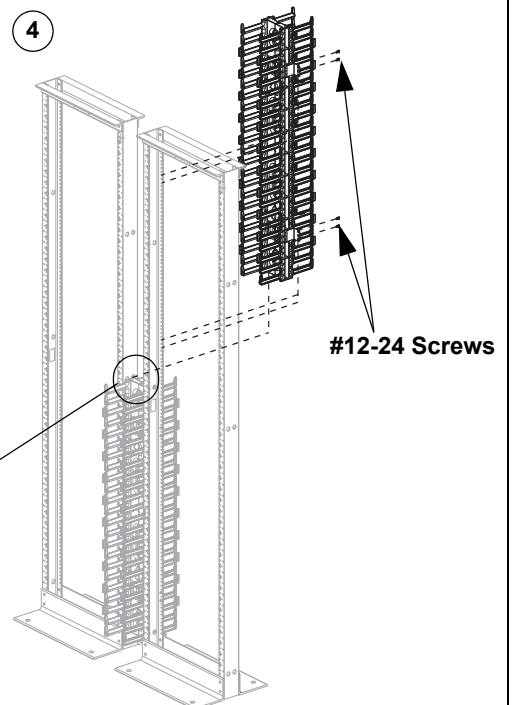

Top Mounting Location

#12-24 Screws

#12-24 Screws

3

Location pin(s)

Installation Instructions R2PS using WMPVSMK side mounting kit

**Note:** Mount the racks to the floor (with the appropriate space between racks indicated in Table 2.)

Table 2

Part Number	Space
WMPV22E WMPV45E WMPVF22E * WMPVF45E *	5"
NRV6 NRVF6 * WMPVHC45E WMPVHCF45E *	6.75"
NRV10 NRVF10*	10"
NRV12 NRVF12 *	12"

\* FOR USE WITH R2P6S

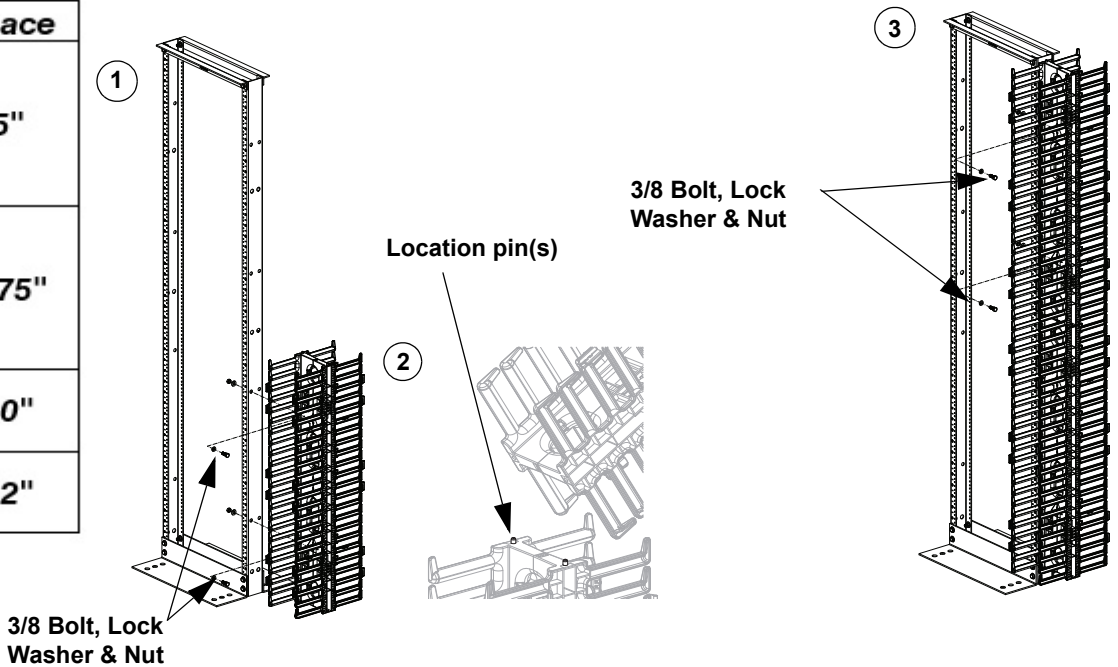

Installation Instructions Required mounting for R2P6S using WMPVSMK side mounting kit

**Note:** Mount the racks to the floor (with the appropriate space between racks indicated in Table 2.)

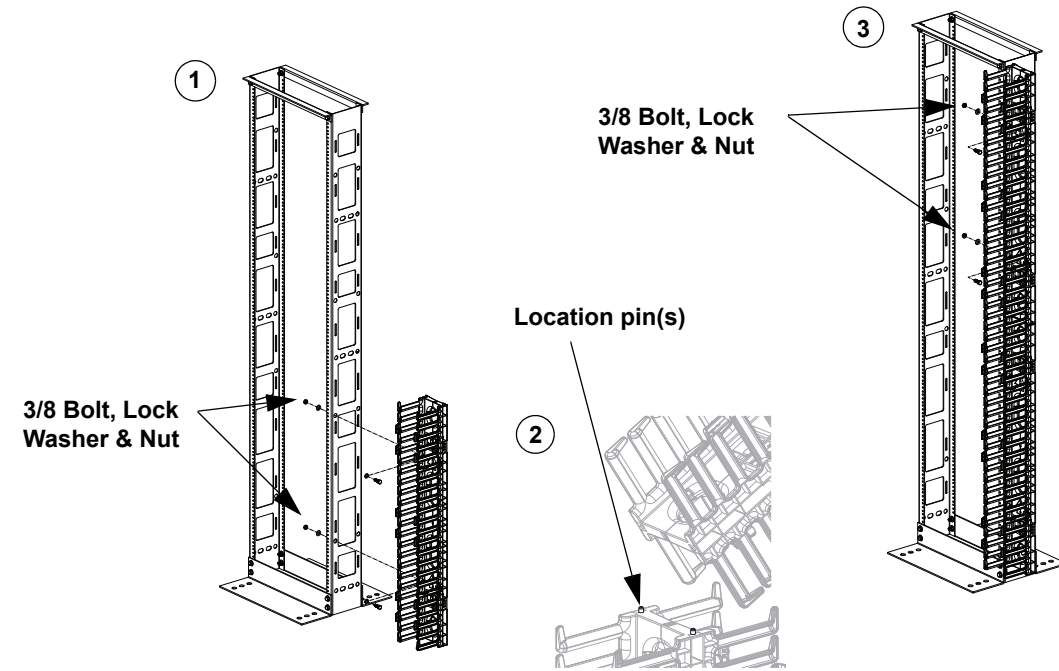

Installing Front Only Managers for Front and Back cable management.

Use a front only manager for additional cable management on the back of the rack (see Table 2 for all compatible managers for this rack)

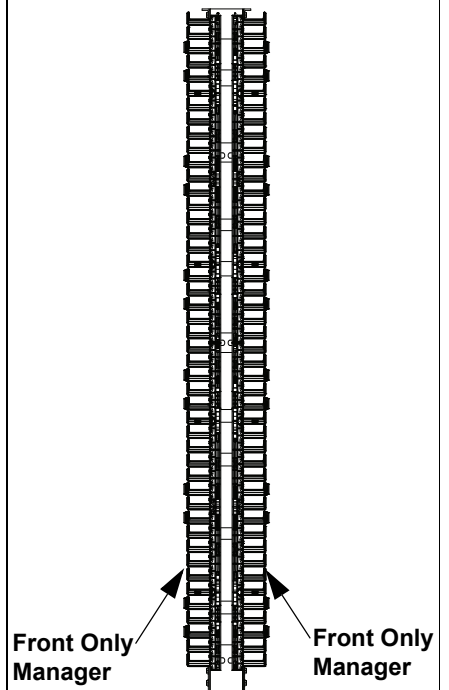

# INSTRUCTIONS CM308F

## Installation Instructions R4P using WMPVSMK side mounting kit

**Note:** Mount the racks to the floor (with the appropriate space between racks indicated in Table 2.)

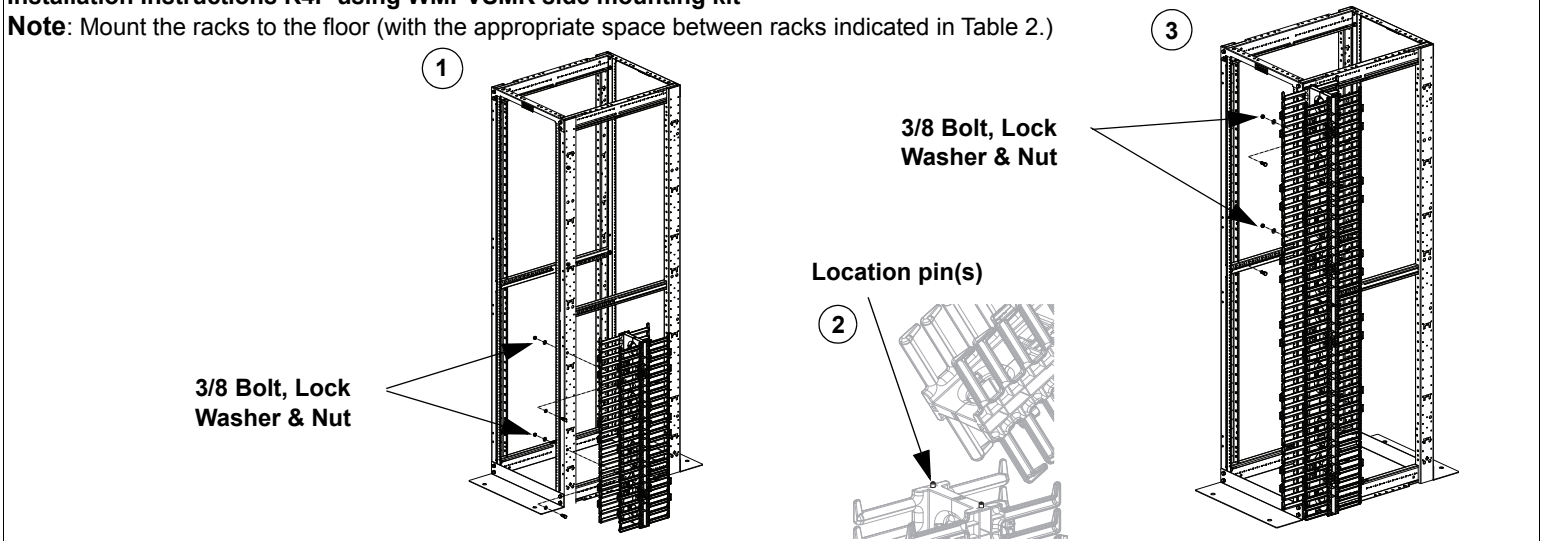

### Opening and Closing Cover for WMPV managers

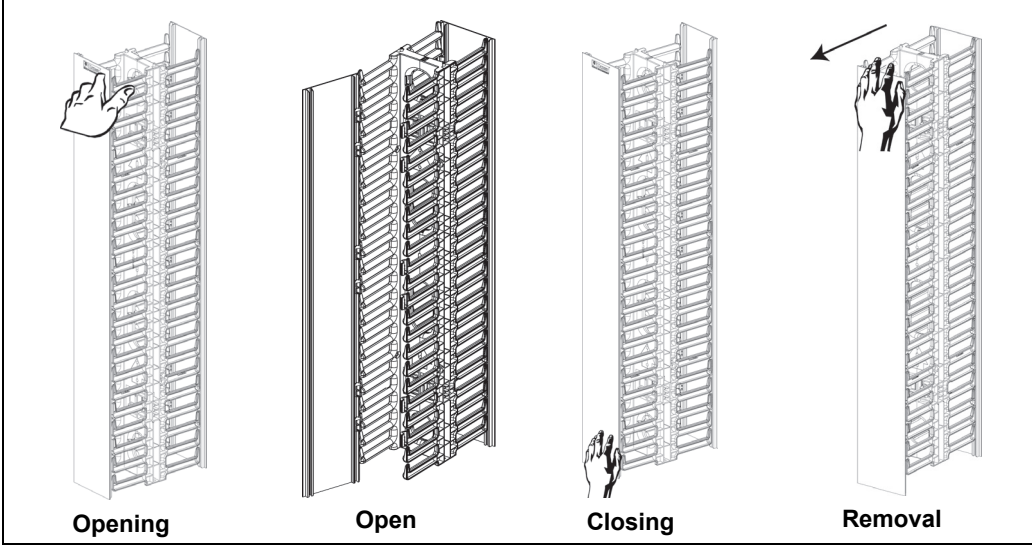

### Wire Retainer Installation (WR5E) SOLD SEPERATELY

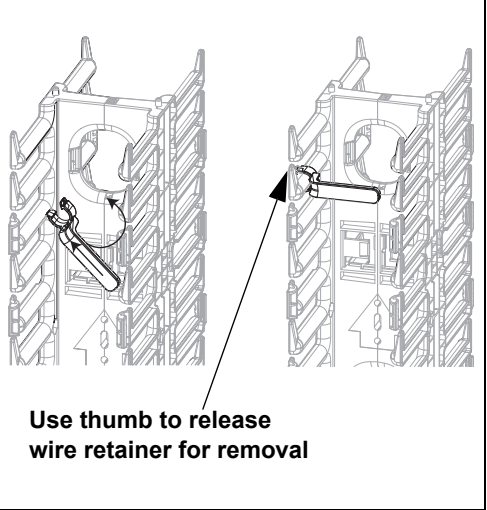

### Opening and Closing Cover for NRV managers

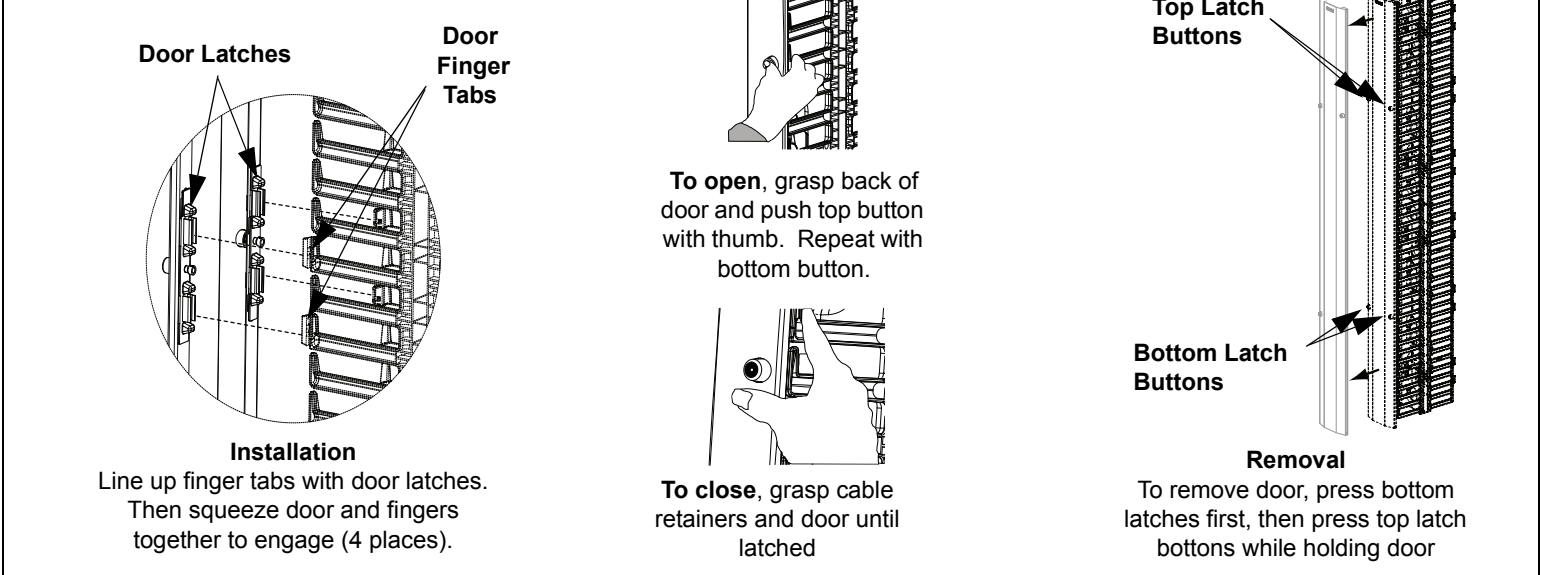

For instructions in Local Languages and Technical Support:

[www.panduit.com/resources/install\\_maintain.asp](http://www.panduit.com/resources/install_maintain.asp)

# PANDUIT

[www.panduit.com](http://www.panduit.com)

E-mail: [techsupport@panduit.com](mailto:techsupport@panduit.com)

Fax: (866)405-6654