



Application Note: AS3930-AN01 – Demo Kit Manual

AS3930

Low Frequency Wake-up Receiver

Table of Contents

1	General Description	4
1.1	Kit Content	4
2	Getting Started	4
3	Hardware.....	5
3.1	AS3930 Demoboard Description	5
3.2	125 kHz Wakeup Transmitter Board.....	6
4	Software	7
4.1	Install the GUI	7
4.2	Description of the GUI of the Receiver	8
4.2.1	Settings Descriptions	8
4.2.1.1	Low Power Mode	8
4.2.1.2	Clock Generator	9
4.2.1.3	Calibrate RC Oscillator	9
4.2.1.4	Antenna Damper	9
4.2.1.5	Gain Reduction	9
4.2.1.6	Automatic Time-Out	9
4.2.1.7	Envelope Detector Time Constant	9
4.2.1.8	Data Slicer.....	9
4.2.1.9	Comparator Hysteresis	9
4.2.1.10	Frequency Detection Tolerance.....	10
4.2.1.11	Wakeup Pattern (Manchester).....	10
4.2.1.12	General Settings	10
4.2.1.13	Correlator	10
4.2.1.14	Symbol Rate.....	10
4.2.1.15	Artificial Wakeup	10
4.2.1.16	Clear Wake	10
4.2.1.17	Reset RSSI	10
4.3	Clear False Wakeup.....	10
4.4	Description of the GUI for the Wake-up Transmitter Board.....	11
4.4.1	Settings Description	11
4.4.1.1	Duration of Carrier Burst	11
4.4.1.2	Number of Preamble Symbols	11
4.4.1.3	Symbol Rate.....	12

4.4.1.4	Enable Buzzer.....	12
4.4.1.5	Wake-up Pattern (Manchester).....	12
4.4.1.6	Manchester Pattern Length.....	12
4.4.1.7	Correlator	12
5	Schematics, BOM and Layouts of Demo Kit.....	13
5.1	AS3930 Demoboard Schematic.....	13
5.2	AS3930 Demoboard Layout – Top and Bottom Layer.....	14
5.3	AS3930 Demoboard BOM	15
5.4	125 kHz Wake-up Transmitter Board Schematics.....	16
5.5	125 kHz Wake-up Transmitter Board Layout	16
5.6	125 kHz Wake-up Transmitter Board BOM	17
6	Ordering Information	17

Revision History

Revision	Date	Owner	Description
1.0	18.04.2011	JPE	Initial Release
1.1	11.03.2013	JRY	Update to Corporate Format

1 General Description

The AS3930 Demo Board demonstrates the main features of the AS3930. These include 1D wake-up pattern detection, readout of false wake-ups, possibility to measure current consumption in different operating modes, and measurement access to SPI communication and data output. Additional features are accessible via USB through the GUI that was developed for easy access to the register map. Features such as the programmable wake-up pattern, adjustable sensitivity level, low power listening modes and several more can be programmed via the GUI. The influence different settings have on the detection efficiency can be observed right away by using the 125 kHz Wake-up Transmitter Board.

1.1 Kit Content

The AS3930 Demo Kit contains the following items:

- 1x AS3930 Demo Board
- 1x 125kHz Wake-up Transmitter Board
- 1x 9V power supply
- 2x CR2032 Coin Cell
- 1x USB stick
- 1x USB Cable

2 Getting Started

- Connect the +9V DC Power Supply at “**F**” on the 125 kHz Wake-up Transmitter Board.
- Start to transmit Wake-up Patterns via AUTO “**C**” or PATTERN “**B**”.
- Insert the +3V Battery at “**H**” of the AS3930 Demo Board.
- Turn on the AS3930 Demo Board via the ON/OFF – switch “**C**”. When turning on the boards all indication-LEDs flash up once.
- As soon as the AS3930 Demo Board receives a Wake-up Pattern, the RSSI LEDs flash up for 0.5s and show the actual Received Signal Strength.

3 Hardware

3.1 AS3930 Demoboard Description

Figure 1: AS3930 Demoboard Description Top and Bottom

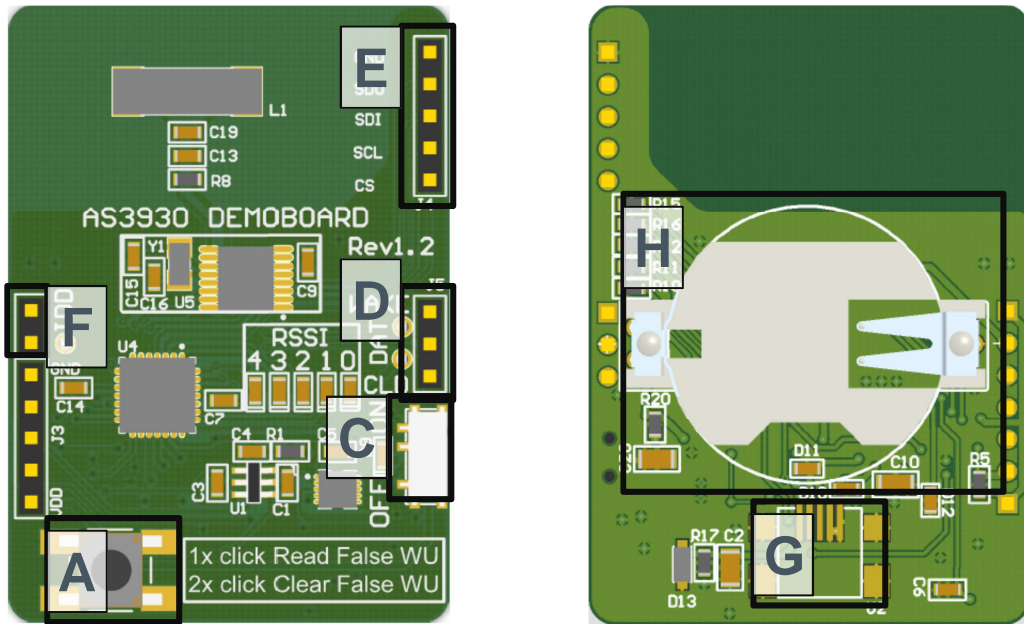

Figure 2: User Interface Description

Label	Name	Description	Info
A	BUTTON	1x short press reads the false wake-ups	The number of false wake-ups can be read out and are displayed via the RSSI – LEDs.
		2x short press (double click) clears the false wake-ups	Pressing FALSE WAKEUP two times resets the number of false wake-ups. Each RSSI – LED is turned on shortly.
C	ON/OFF	ON/OFF – Switch	Power on/off the demoboard. Source (Battery or USB) is automatically detected.
G	USB – Connector	Mini USB 5-pin connector	USB Interface for the GUI
H	CR2032 BATTERY	Battery Holder	Insert CR2032 here.

Figure 3: Jumper Description

Jumper	Name	Description	Info
F	IDD	Supply Current	The supply current of the AS3930 can be measured. Set this jumper for normal operation.

Jumper	Name	Description	Info
D		AS3930 specific outputs	
	D1	WAKE	Wake Output Interrupt
	D2	DAT	Data Output
	D3	CL_DAT	Manchester Recovered Clock
E		Microcontroller - Interface	The SDI –Interface from the microcontroller can be replaced by a proprietary solution
	E1	CS	Serial Digital Interface Chip Select
	E2	SCL	Serial Digital Interface Clock
	E3	SDI	Serial Digital Interface Input
	E4	SDO	Serial Digital Interface Output
	E5	GND	Ground (0V)

Note: To establish a connection between the GUI and the AS3930 the board must be RESET by switching the power OFF and ON via “C”. Alternatively, the buttons “A” and “B” can be pressed simultaneously before connecting the USB cable.

3.2 125 kHz Wakeup Transmitter Board

Figure 4: Transceiver Board Description

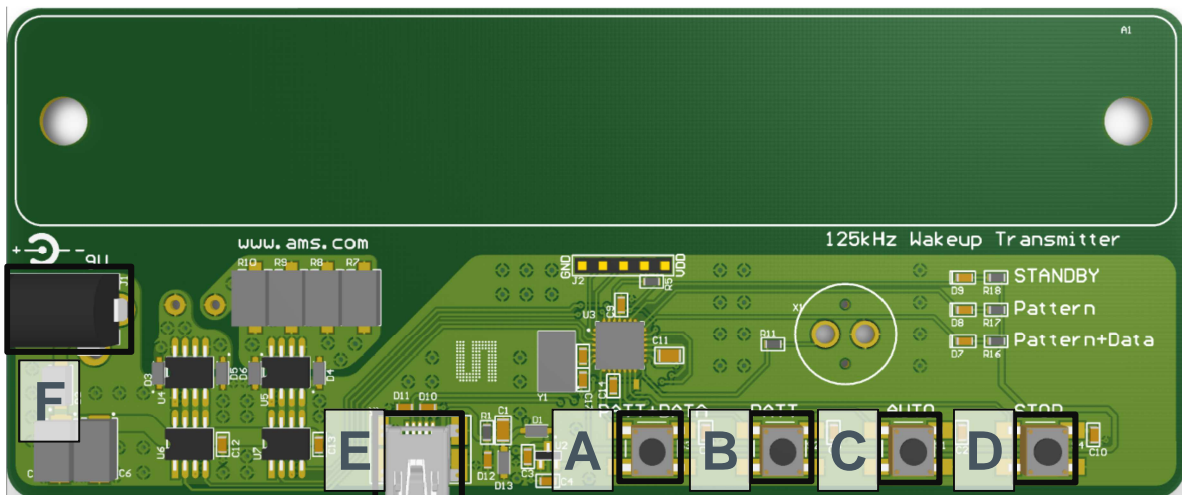

Figure 5: User Interface Description

Label	Name	Description	Info
A	PATT+DATA	Pattern+Data – Button	Pressing this button the transmitter sends continuously the wake-up pattern plus data (01010101).
B	PATT	Single Pattern – Button	Pressing this button the transmitter sends a single wake-up pattern.

Label	Name	Description	Info
C	AUTO	Automatic Pattern – Button	Pressing this button the transmitter automatically sends a wake-up pattern every 1s
D	STOP	Stop Pattern – Button	This button stops sending the continuous wake-up pattern
E	USB-Connector	Mini USB 5-pin Connector	USB Interface for the GUI
F	Power Supply	+9V DC Power Supply (2A)	Insert power adapter here.

Figure 6: Indication LEDs/Buzzer

LEDs	Blinking Color	Info
G	Buzzer	Whenever a wake-up pattern is transmitted the buzzer signals shortly. The buzzer can be disabled via the GUI.
STANDBY	Red LED	Transmitter is on standby. No wake-up pattern is sent.
Pattern	Red LED	Wake-up pattern is transmitted
Pattern+Data	Red LED	Wake-up pattern plus data is transmitted

Note: Before the 125 kHz Wake-up Transmitter is connected to the GUI via USB it is necessary to stop transmitting Wake-up Patterns by pressing the button “D”.

4 Software

4.1 Install the GUI

- Execute the AS393x_EvalSW_v2.1.6b.msi which can be found on the USB stick in the folder ‘Software_Firmware’
- Follow the installation guide
- Run the GUI → AS393x_EvalSW.exe
- Attach the respective board (Demo Board or Transmitter Board) with the USB cable
- From the pop up window ‘Choose Plugin’ choose the ‘AS3932_plugin.dll’

Figure 7: Plugin selection

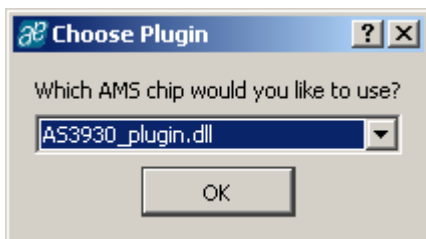

Note: Before connecting the 125 kHz Wake-up Transmitter Board with the USB cable press “D” to stop transmitting wake-up patterns.

4.2 Description of the GUI of the Receiver

Adjustments can be saved with *Store Settings* in the lower right hand corner of the Receiver tab. The default settings can be restored with *Preset Default*. All configurations that are set by the GUI correspond to the Register Map of the AS3930 which can be viewed via View/Register Map (Ctrl+M). The Register Map can be updated manually (File/Readout Registers (Ctrl+R)) or automatically (File/Automatic Update (Ctrl+U)).

Figure 8: AS3930 GUI -- Receiver Tab

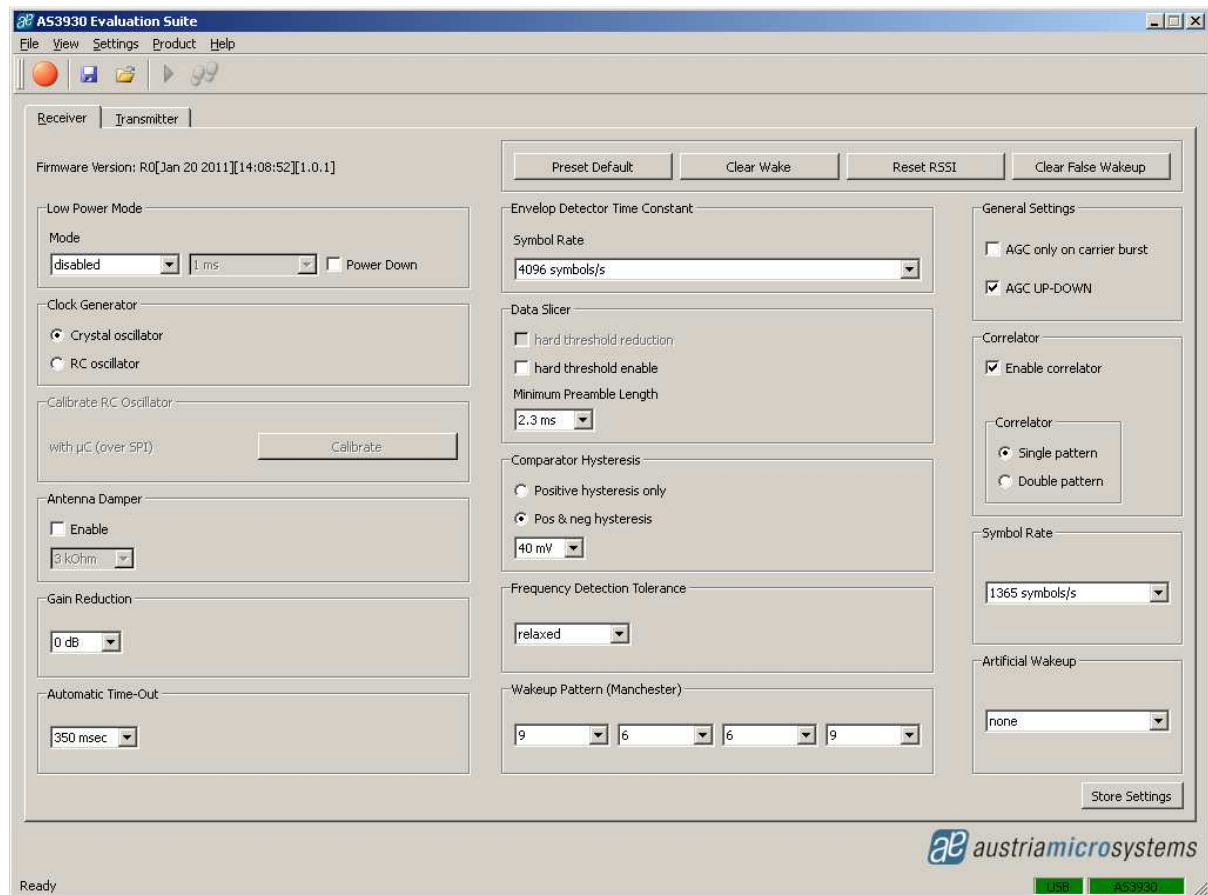

Note: Firmware updates can be done via Help/Firmware Update (Ctrl+F). Load the latest *.bin file to update the firmware.

4.2.1 Settings Descriptions

4.2.1.1 Low Power Mode

The AS3930 features two low power modes which can be selected here. By default no power saving mode is enabled. Thus, the receiver channel is active all the time. For the On/Off mode the channel is activated only part of the time to minimize current consumption. For details please see the AS3930 datasheet.

4.2.1.2 Clock Generator

The clock source for the AS3930 can be selected here. The AS3930 demoboard has an on-board crystal oscillator that is used by default. When the RC oscillator is selected as clock source, its precision can be improved by calibrating the oscillator.

4.2.1.3 Calibrate RC Oscillator

The RC oscillator can be calibrated via the microcontroller or the LC antenna.

4.2.1.4 Antenna Damper

The antenna can be damped in order to limit the range. Therefore, a resistor inside the AS3930 is switched parallel to the antenna. The value of the resistor can be chosen between 1k Ω to 27k Ω .

4.2.1.5 Gain Reduction

The Gain Reduction of the channel amplifier can be selected between 0dB up to -24dB.

4.2.1.6 Automatic Time-Out

The *Automatic Time-Out* resets the WAKE pin automatically after a designated time which can be set between 0ms and 350ms.

4.2.1.7 Envelope Detector Time Constant

The performance of the demodulator can be optimized according to the bit rate and preamble length. If the bit rate increases the time constant has to decrease. Adjust this *ED time constant* according to your symbol rate. The recommended time constants for different symbol rates are listed in the datasheet.

4.2.1.8 Data Slicer

The threshold of the data slicer can be set to a fixed level by setting the 'hard threshold enable' bit. This hard threshold can be reduced by setting the 'hard threshold reduction' bit. Otherwise, the threshold will be dynamically set according to the incoming data signal.

In case the dynamic threshold is used (i.e. the 'hard threshold enable' bit is not set), the data slicer's noise immunity can be adjusted via the data slicer's time constant. The bigger this time constant is, the better its noise immunity will be. However, increasing the time constant is only effective if also the preamble length is increased. Otherwise, the threshold will not have enough time to settle to the correct value. Therefore, the data slicer's time constant is linked to the minimum preamble length. The recommended minimum preamble lengths for different data slicer time constants are listed in the datasheet.

4.2.1.9 Comparator Hysteresis

The comparator hysteresis of the data slicer can be set to either 20mV or 40mV. Furthermore, the data slicer hysteresis can be selected for only positive edges or both positive and negative edges.

4.2.1.10 Frequency Detection Tolerance

The *Frequency Detection Tolerance* can be tighter or more relaxed. For details please see the datasheet.

4.2.1.11 Wakeup Pattern (Manchester)

Select a wakeup pattern here. Each field defines 4 bit. If the transmitted pattern matches the selected pattern, a wakeup interrupt is generated at the WAKE pin. The WAKE pin goes high.

4.2.1.12 General Settings

- AGC only on carrier burst: The automatic gain control is active only on the first carrier burst.
- AGC UP-DOWN: The automatic gain control is operating in both directions (up and down). At the beginning the gain of the channel amplifier is set to the maximum and the AGC reduces it according to the received signal input level. If AGC UP-DOWN is disabled the AGC can only decrease the gain for the whole duration of the data reception. In this mode the system holds the RSSI peak.

4.2.1.13 Correlator

- Enable correlator: If the correlator is enabled the chip searches first for the preamble bits and then for the data pattern (Manchester encoded Wakeup Pattern). Should the pattern correlation be disabled, the AS3930 goes directly in data receiving mode.
- Single pattern: The wakeup pattern is sent as single string.
- Double pattern: The wakeup pattern is doubled.

4.2.1.14 Symbol Rate

The *Symbol Rate* can be adjusted between 512 Symbols/s and 4096 Symbols/s. The symbol rate defines the duration of one bit via the 32.768 kHz Clock in order to recover the data.

4.2.1.15 Artificial Wakeup

It is possible to enable the artificial wakeup with a period between 1s and 2 hours.

4.2.1.16 Clear Wake

The *Clear Wake Button* resets the WAKE pin manually.

4.2.1.17 Reset RSSI

Reset the current RSSI measurement.

4.2.1.18 Clear False Wakeup

The False Wakeup register counts the number of frequency detections that do not match the wakeup pattern. The accumulated number of false wakeups can be reset via the *Clear False Wakeup* button.

4.3 Description of the GUI for the Wake-up Transmitter Board

All adjustments that are made to the settings can be saved via “**Store Settings**” in the lower right corner of the ‘Transmitter’ tab. The settings can be reset to the default configuration by pushing the button “**Restore Default Settings**”.

Note: A possible Firmware Update can be done via Help/Firmware Update (Ctrl+F). Load the latest *.bin file for the transmitter and update the firmware.

Figure 9: Graphical User Interface (GUI) for the 125 kHz Wake-up Transmitter Board

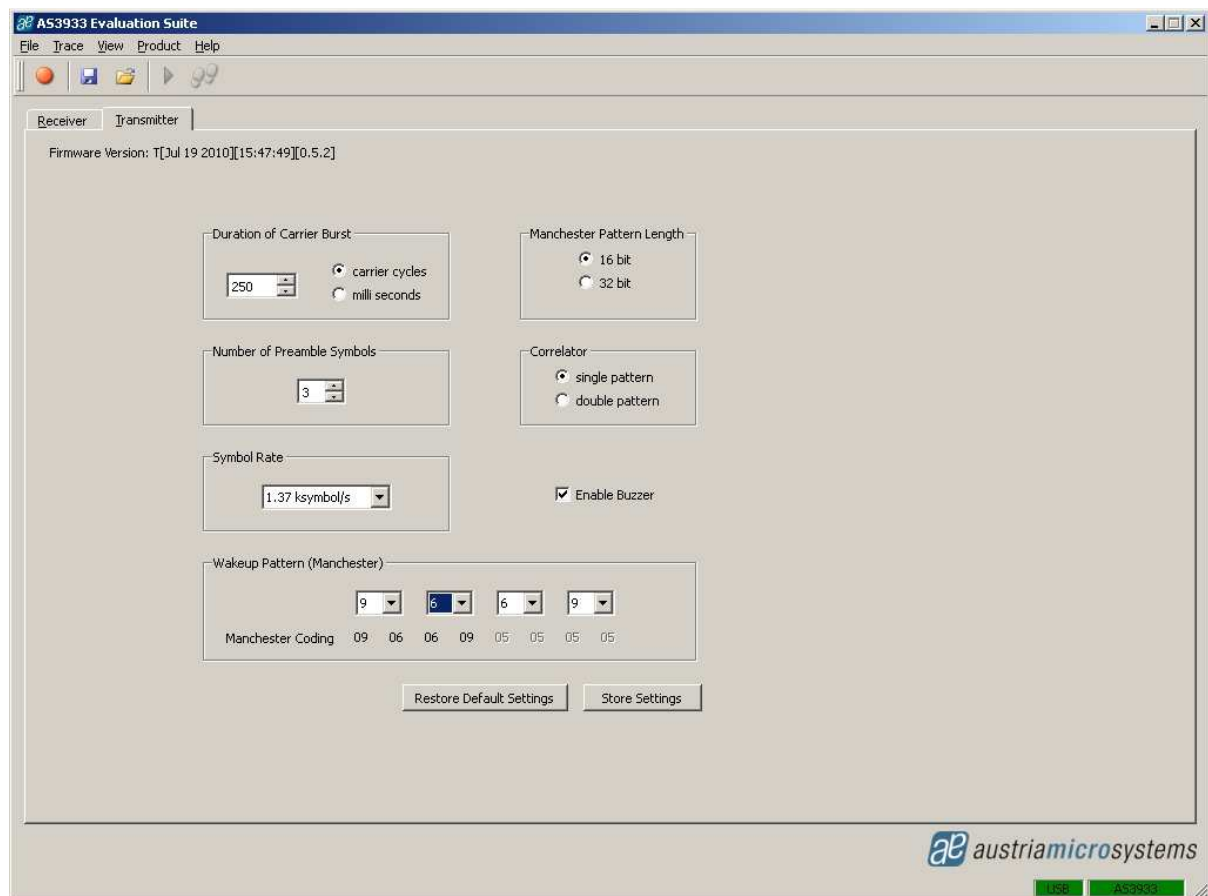

4.3.1 Settings Description

4.3.1.1 Duration of Carrier Burst

The duration of the carrier burst can be set in multiples of carrier cycles (0-500 x 8µs) or in milliseconds (1-3).

4.3.1.2 Number of Preamble Symbols

The carrier burst must be followed by a separation bit and at least 3 symbols preamble. The number of preamble symbols that are sent can be adjusted here.

4.3.1.3 Symbol Rate

The symbol rate can be adjusted between 512 symbols/s and 4096 symbols/s. The symbol rate must be the same as the symbol rate set for the AS3932.

4.3.1.4 Enable Buzzer

The Wake-up Transmitter Board sends out an acoustic signal whenever a packet is transmitted. This signal can be disabled.

4.3.1.5 Wake-up Pattern (Manchester)

The wake-up pattern of the transmitter must be the same as the pattern defined for the receiver in order to generate a successful wake-up at the receiver.

4.3.1.6 Manchester Pattern Length

This setting must also be the same as defined for the receiver to generate a successful wake-up.

4.3.1.7 Correlator

This setting must also be the same as defined for the receiver to generate a successful wake-up.

5 Schematics, BOM and Layouts of Demo Kit

5.1 AS3930 Demoboard Schematic

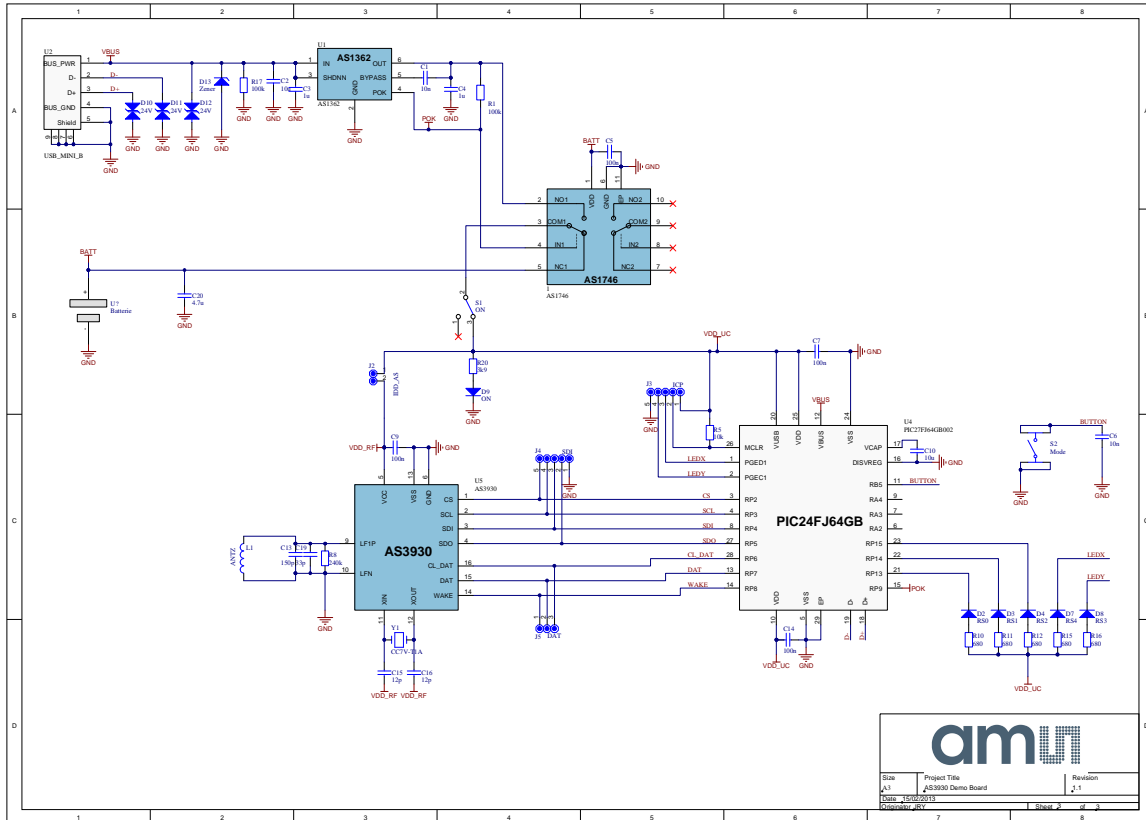

5.2 AS3930 Demoboard Layout – Top and Bottom Layer

Figure 10: AS3930 Demoboard Layout – Top Layer

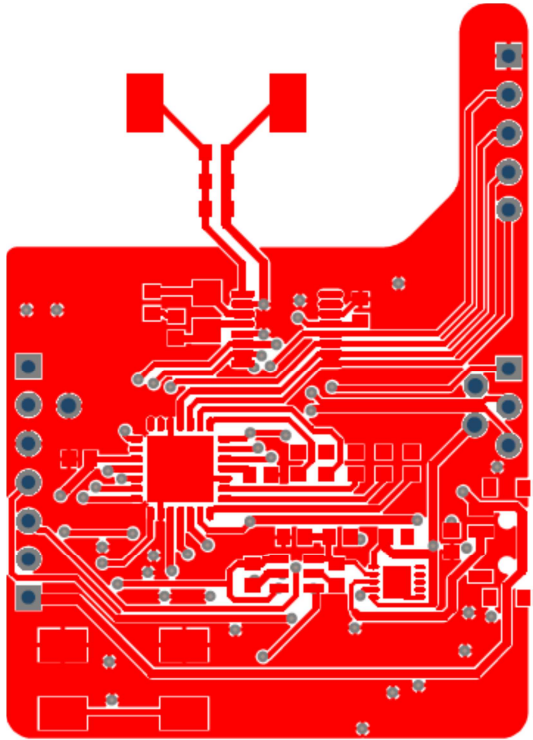
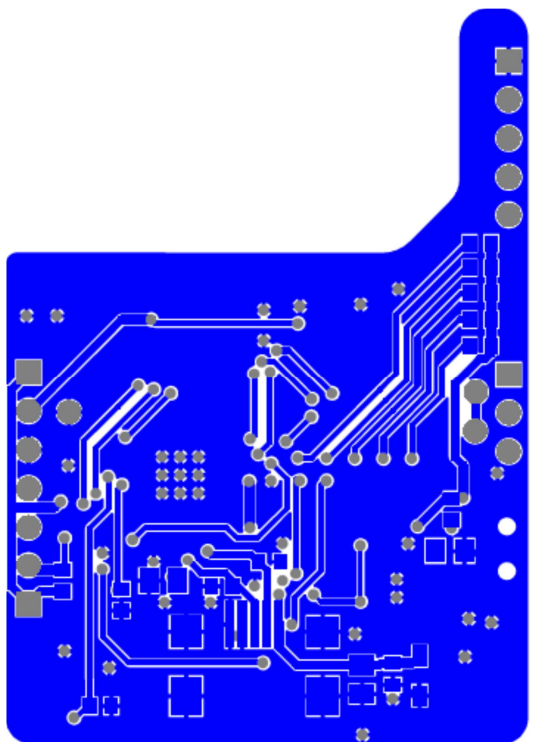

Figure 11: AS3930 Demoboard Layout – Bottom Layer





5.3 AS3930 Demoboard BOM

Bill of Materials			AS3930 Demo Board			
Company:			ams AG			
Originator:			JRY			
PCB Name:			AS3930 Demo Board			
PCB Version:			1.1			
Report Date:			15/02/2013			
#	Designator	Comment	Component Description	Manufacturer	Manufacturer Part Number	Quantity
1	1	AS1746	IC SWITCH DUAL SPDT 10-	ams	AS1746-BTDT	1
2	C1, C6	10n	C0603/10V/X5R			2
3	C2, C10	10u	C0805/6.3V/X5R			2
4	C3, C4	1u	YAGEO (PHYCOMP) -	YAGEO (PHYCOMP)	CC0603KRXSR6B105	2
5	C5, C7, C9, C14	100n	C0603/10V/X5R			4
6	C13	150p	Multilayer Ceramic	Murata	GRM1885C1H151GA01D	1
7	C15, C16	12p	TDK -	TDK	C1608COG1H120J080AA	2
8	C19	33p	Multilayer Ceramic	Murata	GRM1885C2A330GA01D	1
9	C20	4.7u	C0805/6.3V/X5R			1
10	D2	RS0	MULTICOMP - OVS-0608 -	MULTICOMP	OVS-0608	1
11	D3	RS1	MULTICOMP - OVS-0608 -	MULTICOMP	OVS-0608	1
12	D4	RS2	MULTICOMP - OVS-0608 -	MULTICOMP	OVS-0608	1
13	D7	RS4	MULTICOMP - OVS-0608 -	MULTICOMP	OVS-0608	1
14	D8	RS3	MULTICOMP - OVS-0608 -	MULTICOMP	OVS-0608	1
15	D9, S1	ON	MULTICOMP - OVS-0608 -	MULTICOMP, C & K	OVS-0608, PCM12SMTR	2
16	D10, D11, D12	24V	COOPER BUSSMANN -	COOPER BUSSMANN	0603ESDA-TR1	3
17	D13	Zener	ON SEMICONDUCTOR -	ON SEMICONDUCTOR	MM3Z6V8T1G	1
18	J2	IDD_AS	2 pole pin header			1
19	J3	ICP	not assembled			1
20	J4	SDI	5 pole pin header			1
21	J5	DAT	3 pole pin header			1
22	L1	ANTZ	7.2mH +/- 5% @ 125kHz	Premo	SDTR1103-0720J	1
23	R1, R17	100k	R0603/5%/0.1W			2
24	R5	10k	R0603/5%/0.1W			1
25	R8	240k	R0603/5%/0.1W			1
26	R10, R11, R12, R15, R16	680	R0603/5%/0.1W			5
27	R20	3k9	R0603/5%/0.1W			1
28	S2	Mode	TE CONNECTIVITY /	TE CONNECTIVITY /	FSM2JSMA	1
29	U1	AS1362	IC REG LDO 3V .3A TSOT23	ams	AS1362-BTTT-30	1
30	U2	USB_MINI_B	CONN RECEPT MINI USB2.0	Hirose Electric Co Ltd	UX60A-MB-5ST	1
31	U4	PIC27FJ64GB002	MICROCHIP -	MICROCHIP	PIC24FJ64GB002-VML	1
32	U5	AS3930	IC RF PROGRAM RECEIVER	ams	AS3930-BQFT	1
33	U7	Batterie	RENATA - HU2032-LF -	RENATA	HU2032-LF	1
34	Y1	CC7V-T1A	MICRO CRYSTAL - CC7V-	MICRO CRYSTAL	CC7V-T1A 32.768KHZ +/-20PPM 9PF	1
Approved			Notes			49

5.4 125 kHz Wake-up Transmitter Board Schematics

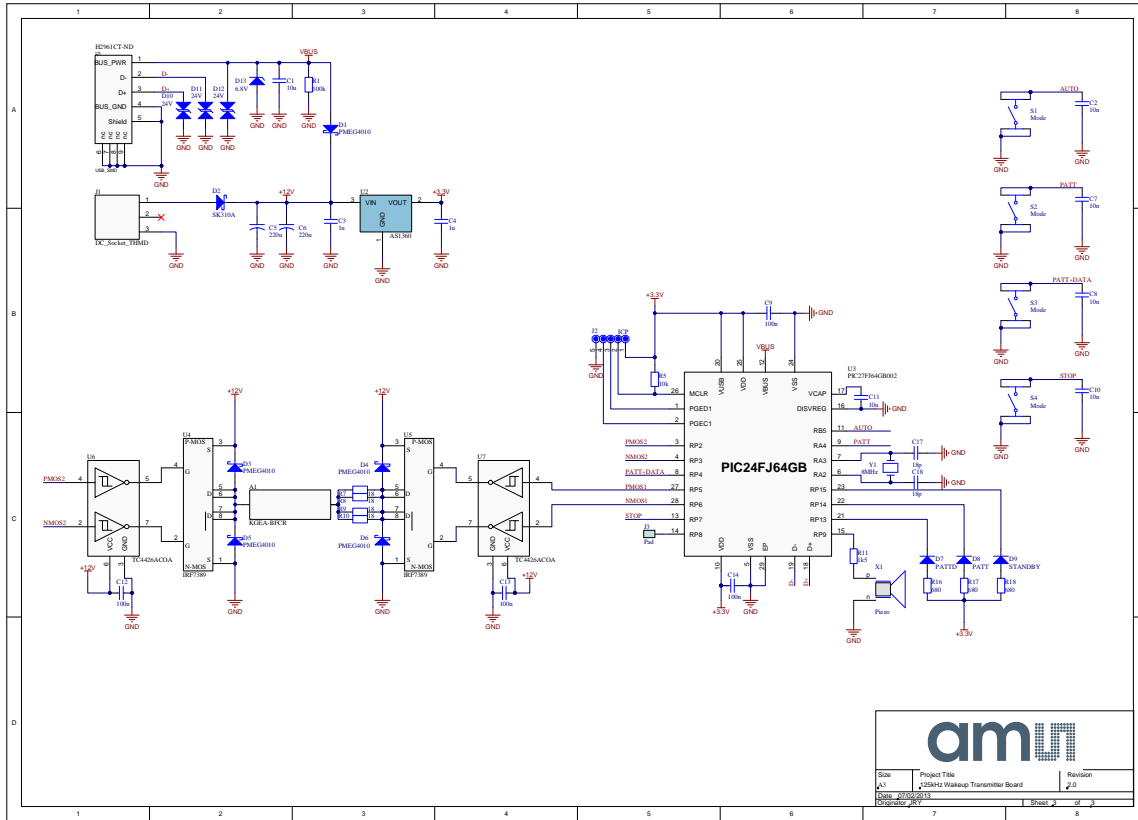

5.5 125 kHz Wake-up Transmitter Board Layout

Figure 12: 125 kHz Wake-up Transmitter Board Layout – Top Layer

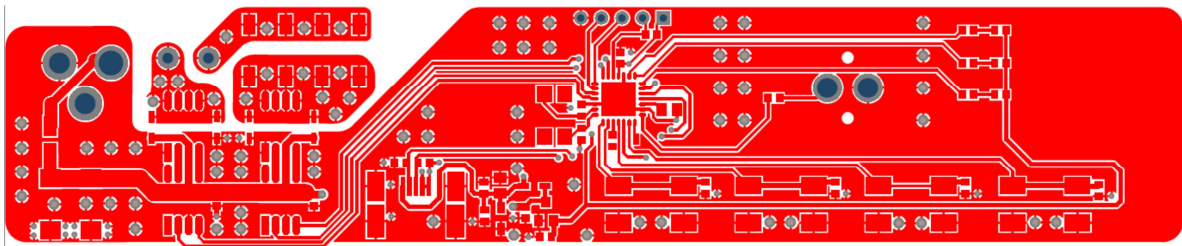
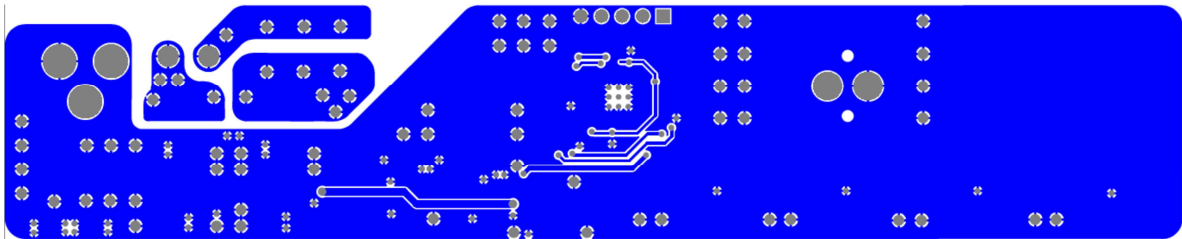

Figure 13: 125 kHz Wake-up Transmitter Board Layout – Bottom Layer



5.6 125 kHz Wake-up Transmitter Board BOM

Bill of Materials			125kHz Wakeup Transmitter Board			
Company:			ams AG			
Originator:			JRY			
PCB Name:			125kHz Wakeup Transmitter Board			
PCB Version:			2.0			
Report Date:			07/02/2013			
#	Designator	Comment	Component Description	Manufacturer	Manufacturer Part Number	Quantity
1	A1	KGEA-BFCR	LF Antenna/KGEA-BFCR-B-			1
2	C1, C11	10u	C080516V/X5R			2
3	C2, C7, C8, C10	10n	C060310V/X5R			4
4	C3, C4	1u	MULTICOMP -	MULTICOMP	MC0603X105M160CT	2
5	C5, C6	220u	KEMET - T491D227K016ZT -	KEMET	T491D227K016ZT	2
6	C9, C12, C13, C14	100n	C060310V/X5R			4
7	C17, C18	18p	C060350V/X5R			2
8	D1, D3, D4, D5, D6	PMEG4010	NXP - PMEG4010CEJ,115 -	NXP	PMEG4010CEJ,115	5
9	D2	SK310A	TAIWAN SEMICONDUCTOR -	TAIWAN SEMICONDUCTOR	SK310A	1
10	D7	PATTD	MULTICOMP - OVS-0608 -	MULTICOMP	OVS-0608	1
11	D8	PATT	MULTICOMP - OVS-0608 -	MULTICOMP	OVS-0608	1
12	D9	STANDBY	MULTICOMP - OVS-0608 -	MULTICOMP	OVS-0608	1
13	D10, D11, D12	24V	COOPER BUSSMANN -	COOPER BUSSMANN	0603ESDA-TR1	3
14	D13	6.8V	ON SEMICONDUCTOR -	ON SEMICONDUCTOR	MM3Z6V8T1G	1
15	J1	DC_Socket_THMD	LUMBERG - NEB 21 R -	LUMBERG	NEB 21 R	1
16	J2	ICP	5 pole pin header/2.54mm			1
17	R1	100k	R06035%0.1W			1
18	R5	10k	R06035%0.1W			1
19	R7, R8, R9, R10	18	TE CONNECTIVITY / CGS -	TE CONNECTIVITY / CGS	SMW218RJT	4
20	R11	1k5	R06035%0.1W			1
21	R16, R17, R18	680	VISHAY DRALORIC -	VISHAY DRALORIC	CRCW0603680RFKEAHP	3
22	S1, S2, S3, S4	Mode	TE CONNECTIVITY /	TE CONNECTIVITY /	FSM2J5MA	4
23	U1	USB_SMD	CONN RECEPT USB 5POS	Molex Connector	56579-0576	1
24	U2	AS1360	IC REG LDO 3.3V .15A	ams	AS1360-33-T	1
25	U3	PIC27FJ64GB002	MICROCHIP -	MICROCHIP	PIC24FJ64GB002-JML	1
26	U4, U5	IRF7389	INTERNATIONAL RECTIFIER -	INTERNATIONAL RECTIFIER	IRF7389TRPBF	2
27	U6, U7	MC33151	ON SEMICONDUCTOR -	ON SEMICONDUCTOR	MC33151DG	2
28	X1	Piezo	MURATA -	MURATA	PKM13EPYH4002-B0	1
29	Y1	8MHz	ABRACON - ABMM2-	ABRACON	ABMM2-8.000MHZ-E2-T	1
Approved			Notes			55

6 Ordering Information

Figure 14: Ordering Information

Ordering Code	Type	Marking	Delivery Form ¹	Delivery Quantity
AS3930-BTST	16-pin TSSOP	AS3930	7 inches Tape & Reel	1000 pcs
AS3930-BQFT	QFN 4x4 16LD	AS3930	7 inches Tape & Reel	1000 pcs

1. Dry Pack: Moisture Sensitivity Level (MSL) = 3, according to IPC/JEDEC J-STD-033A.

Note: All products are RoHS compliant and ams green.

Buy our products or get free samples online at ICdirect: <http://www.ams.com/ICdirect>

Technical Support is available at <http://www.ams.com/Technical-Support>

For further information and requests, please contact us [mailto: sales@ams.com](mailto:sales@ams.com)

or find your local distributor at <http://www.ams.com/distributor>

Disclaimer

Devices sold by ams AG are covered by the warranty and patent indemnification provisions appearing in its Term of Sale. ams AG makes no warranty, express, statutory, implied, or by description regarding the information set forth herein or regarding the freedom of the described devices from patent infringement. ams AG reserves the right to change specifications and prices at any time and without notice. Therefore, prior to designing this product into a system, it is necessary to check with ams AG for current information.

This product is intended for use in normal commercial applications. Applications requiring extended temperature range, unusual environmental requirements, or high reliability applications, such as military, medical life-support or lifesustaining equipment are specifically not recommended without additional processing by ams AG for each application. For shipments of less than 100 parts the manufacturing flow might show deviations from the standard production flow, such as test flow or test location.

The information furnished here by ams AG is believed to be correct and accurate. However, ams AG shall not be liable to recipient or any third party for any damages, including but not limited to personal injury, property damage, loss of profits, loss of use, interruption of business or indirect, special, incidental or consequential damages, of any kind, in connection with or arising out of the furnishing, performance or use of the technical data herein. No obligation or liability to recipient or any third party shall arise or flow out of ams AG rendering of technical or other services.

Copyright

Copyright © 1997-2012, ams AG, Tobelbader Strasse 30, 8141 Unterpremstaetten, Austria-Europe. Trademarks Registered ®. All rights reserved. The material herein may not be reproduced, adapted, merged, translated, stored, or used without the prior written consent of the copyright owner.

All products and companies mentioned are trademarks or registered trademarks of their respective companies.