

DWG. NO. SD-54928-004

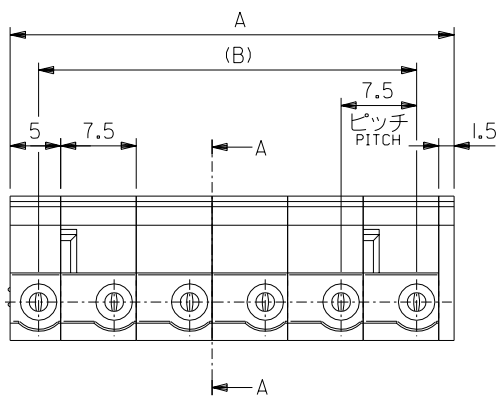
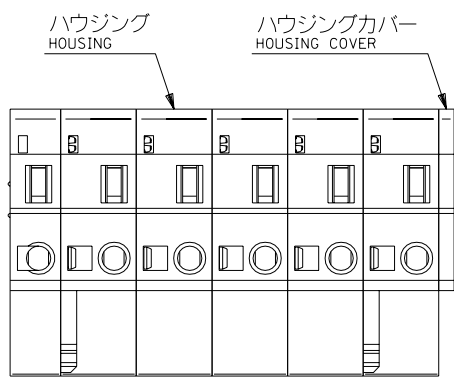
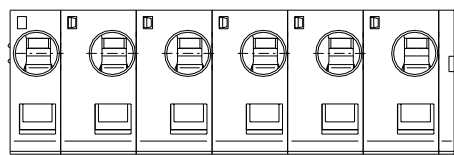

注記 NOTES:

1. 材質 MATERIAL

- ハウジング, ハウジングカバー
HOUSING, HOUSING COVER
ガラス無しポリブチレンテレフタレート, UL94V-0
POLYBUTYLENE TEREPHTHALATE, GLASS NON FILLED, UL94V-0
- ターミナル
TERMINAL
銅合金
COPPER ALLOY
- スプリング
SPRING
ステンレス
STAINLESS STEEL

2. メッキ仕様 PLATING

- 鍍メッキ: 1.0µm MIN.
TIN PLATING: 1.0 MICROMETER MINIMUM
- ニッケルメッキ: 1.0µm MIN. (下地メッキ)
NICKEL PLATING: 1.0 MICROMETER MINIMUM (UNDER PLATING)

3. 適用電線範囲: AWG#14~#26
APPLICABLE WIRE: AWG#14~#26

- 4. 被覆外径: φ3.8 MAX.
INS. DIA.: φ3.8 MAX.
- 5. 適合レバー: 54932 シリーズ
APPLIED LEVER: 54932 SERIES
- 6. 製品番号
MATERIAL NO. 54928-***7*

極数 CIRCUIT SIZE		色 COLOR
アイボリー IVORY	0	
黒 BLACK	1	
灰 GRAY	5	

- 7. 被覆剥き長さ: 8~9mm
INSULATION STRIPPING LENGTH: 8~9mm

8. 本製品は 54928-***1* の鉛フリー品である。
THIS PRODUCT IS LEAD FREE OF 54928-***1*.

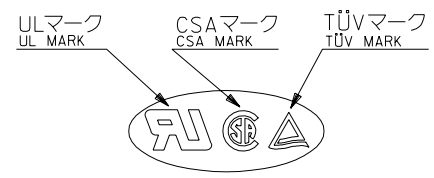

詳細 B
DETAIL B
(SCALE 4:1)

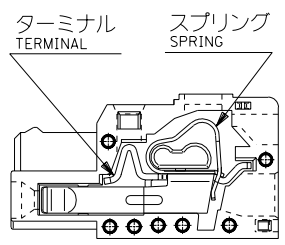

断面 A-A
SECTION A-A

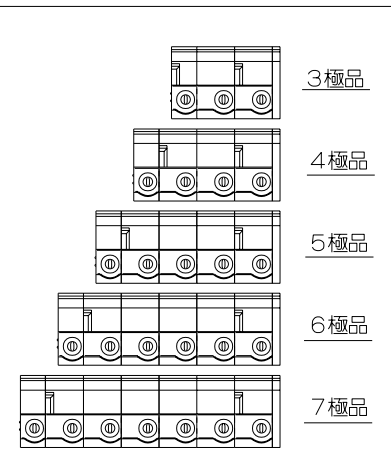

45	51.5	54928-077*	7
37.5	44	54928-067*	6
30	36.5	54928-057*	5
22.5	29	54928-047*	4
15	21.5	54928-037*	3
B	A	製品番号 MATERIAL NO.	極数 CIRCUITS

DO NOT SCALE DRAWING

EC NO. DRWN: CHK: APPR:	EC NO. DRWN: CHK: APPR:	EC NO. DRWN: CHK: APPR:	EC NO. DRWN: CHK: APPR:	EC NO. DRWN: CHK: APPR:
0	0	0	0	0

REV	DESCRIPTION	MATERIAL 材料	注記参照 SEE NOTES
0	RELEASED	FINISH 仕上げ	注記参照 SEE NOTES
0	0	WIRE RANGE 適用電線範囲	注記参照 SEE NOTES
0	0	INS. RANGE 被覆外径	注記参照 SEE NOTES

GENERAL TOLERANCES: (UNLESS SPECIFIED) 一般公差	SCALE 2:1	DESIGN UNITS mm INCH
10 UNDER 未満	±0.2	DRAWN BY & DATE H.KAWABATA '04/04/07
10 OVER 30 UNDER 以上 未満	±0.25	CHECKED BY & DATE K.TOJO '04/04/07
30 OVER 以上	±0.3	APPROVED BY & DATE M.SASAO '04/04/07
ANGLE 角度	±3°	CAD FILENAME SD-54928-004.S01

MODEL NO. 54928-***7*	DIMENSIONS: mm INCH mm INCH		SHT REV
THIRD ANGLE PROJECTION	mm INCH	mm INCH	REVISE ON CAD ONLY
TITLE: MTC (MULTI TERMINAL CONN.) 7.5mm PITCH REC. HS'G ASS'Y -LEAD FREE-			
MOLEX MOLEX INCORPORATED			
CAD FILENAME SD-54928-004.S01	MATERIAL NO. SEE CHART	DRAWING NO. SD-54928-004	SHEET NO. 1 OF 2
THIS DRAWING CONTAINS INFORMATION THAT IS PROPRIETARY TO MOLEX INCORPORATED AND SHOULD NOT BE USED WITHOUT WRITTEN PERMISSION.			SIZE B

DWG. NO. SD-54928-004

ストリップゲージの使用法
USE OF STRIP GAUGE

ハウジングカバーに付いているストリップゲージは、以下のご使用下さい。
PLEASE USE THE STRIP GAUGE WHICH HAS ADHERED TO THE HOUSING COVER AS SHOWN IN THE FIGURE BELOW.

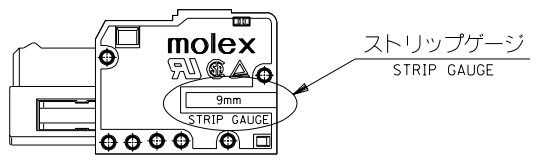

1. 電線をストリップゲージに合わせて被覆を剥く。
THE ELECTRIC WIRE IS MATCHED TO THE STRIP GAUGE, AND STRIPPING INSULATION.

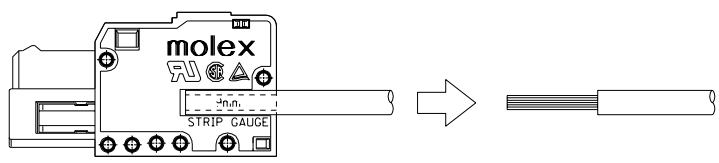

2. 既に被覆を剥いた電線をストリップゲージに合わせて被覆剥き長さを確認する。
THE ELECTRIC WIRE WHICH HAS ALREADY PEELLED OFF INSULATION IS MATCHED TO THE STRIP GAUGE, AND THE STRIPPING LENGTH IS CONFIRMED.

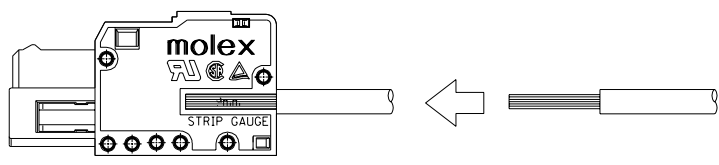

※ 被覆剥き長さ : 8 ~ 9mm
STRIPPING LENGTH : 8 ~ 9mm

結線方法
METHOD OF CONNECTING WIRES

結線レバー
LEVER
54932-****

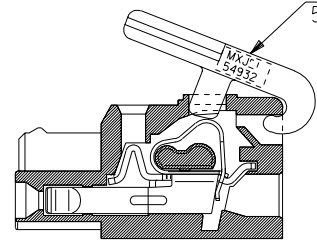

1. 結線レバーをハウジングに装着する。(脱着自在)
THE LEVER OF CONNECTING WIRES IS INSTALLED IN THE HOUSING. (DETACHING IS FREE)

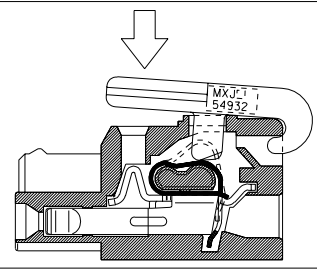

2. 結線レバーを矢印方向に押す。
THE LEVER OF CONNECTING WIRES IS PUSHED IN THE DIRECTION OF THE ARROW.

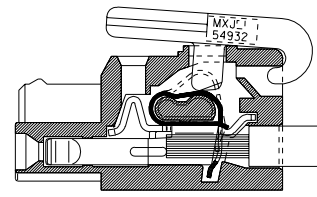

3. 結線レバーを押したまま電線を矢印方向に挿入する。
THE ELECTRIC WIRE IS INSERTED IN THE DIRECTION OF THE ARROW WITH THE LEVER OF CONNECTING WIRES PUSHED.

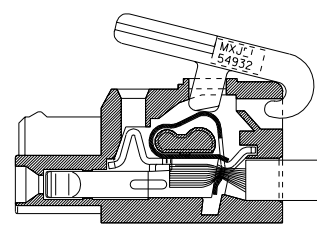

4. 結線レバーを放す。
THE LEVER OF CONNECTING WIRES IS RELEASED.

DO NOT SCALE DRAWING

EC NO. DRWN: CHK: APPR:	EC NO. DRWN: CHK: APPR:	EC NO. DRWN: CHK: APPR:	EC NO. DRWN: CHK: APPR:
EC NO. DRWN: CHK: APPR:	EC NO. DRWN: CHK: APPR:	EC NO. DRWN: CHK: APPR:	EC NO. DRWN: CHK: APPR:

RELEASED
EC NO. J2004-3622
DRWN: H.KAWABATA '04/04/07
CHK: K.TOJO '04/04/07
APPR: M.SASAO '04/04/07

MATERIAL 材料
FINISH 仕上げ
WIRE RANGE 適用電線範囲
INS. RANGE 被覆外径

注記参照
SEE NOTES

注記参照
SEE NOTES

注記参照
SEE NOTES

GENERAL TOLERANCES: (UNLESS SPECIFIED) 一般公差	SCALE 2:1	DESIGN UNITS mm INCH	THIRD ANGLE PROJECTION	DIMENSIONS: mm INCH mm ONLY	SHT	REV
10 UNDER 未満	±0.2	mm INCH	THIRD ANGLE PROJECTION	mm ONLY		
10 OVER 以上 30 UNDER 未満	±0.25					
30 OVER 以上	±0.3					
ANGLE 角度	±3°					

MODEL NO. 54928-***7*
DRAWN BY & DATE
H.KAWABATA '04/04/07
CHECKED BY & DATE
K.TOJO '04/04/07
APPROVED BY & DATE
M.SASAO '04/04/07
CAD FILENAME
SD-54928-004.S02

TITLE: MTC (MULTI TERMINAL CONN.)
7.5mm PITCH REC. HS'G ASS'Y
-LEAD FREE-
MATERIAL NO. SEE CHART
DRAWING NO. SD-54928-004

SHEET NO. 2 OF 2
THIS DRAWING CONTAINS INFORMATION THAT IS PROPRIETARY TO MOLEX INCORPORATED AND SHOULD NOT BE USED WITHOUT WRITTEN PERMISSION.
SIZE B
EN-02J(097) MXJ-54