

## Screw Connection Dual Level

- **Plastic Body:** Polyamide 66.6 VO
- **Internal Bus:** Silver plated copper
- **Clamp:** Hardened steel, electro-plated with zinc yellow chromated
- **Screws:** Steel, zinc plated and yellow chromated
- **Marking:** 4 slots on both sides
- **Tracking Resistance:** IEC 112: CTI > 600 VDE 0303: KB > 600

### 6204110 D 4-2/6 LED

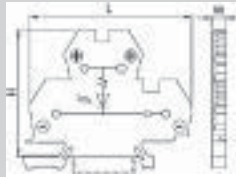
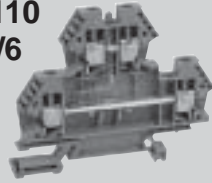

### 6204130 D 4-2/6 LED

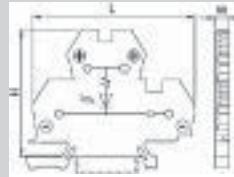
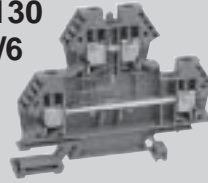

## Screw Connection Triple Level

- **Plastic Body:** Polyamide 66.6 VO
- **Internal Bus:** Silver-plated copper
- **Clamp:** Nickel-plated brass
- **Screws:** Zinc plated and yellow-chromated steel
- **Tracking Resistance:** IEC 112: CTI > 600 VDE 0303: KB > 600

### Dimensions

### Stripping Length

### Connecting Capacity

### Number of Connectable Conductors

### Approvals

### Wire Range

### Voltage Rating

### Current Rating

### Tightening Torque

### Gauges

### ACCESSORIES

### Available Colors

### End Plate Qty. pk. 25

**Jumpers** 2 pole / Blue  
3 pole / Blue  
4 pole / Blue  
12-Pole / Blue  
2 pole / Red  
3 pole / Red  
4 pole / Red  
12-Pole / Red

### End Bracket Qty. pk. 50

### Dimensions

72 mm (L) x 55 mm (H) x  
6 mm (W)

### Opening

4 x 3.3 mm

### Stripping Length

10 mm

### Screw Thread

M 3

### Rating

3, 4 K / 12-24V

### Connecting Capacity

Solid conductors mm<sup>2</sup> 0.5-6  
Stranded conductors  
mm<sup>2</sup> 0.5-4

### Conductors with Ferrules

DIN 46288 / 1 mm<sup>2</sup> 0.5-4

### Number of Connectable Conductors

4 x 1.5 mm<sup>2</sup>

### Approvals



### Wire Range

24-10 AWG | 24-10 AWG | 4 mm<sup>2</sup>

### Voltage Rating

### Current Rating

### Tightening Torque

Max 0.6 Nm

### Gauges

A4

### ACCESSORIES

### End Plate Qty. pk. 10

**6800014** – 72 mm (L) x  
55 mm (H) x 1.5 mm (W)

### Cover Qty. pk. 100

**6800080** – 36 mm (L) x  
14 mm (H) x 6 mm (W)

### End Bracket Qty. pk. 100

**6804150** – 58 mm (L) x  
36 mm (H) x 9 mm (W)

72 mm (L) x 55 mm (H) x  
6 mm (W)

4 x 3.3 mm

10 mm

M 3

34 K / 119V

Solid conductors mm<sup>2</sup> 0.5-6  
Stranded conductors  
mm<sup>2</sup> 0.5-4

DIN 46288 / 1 mm<sup>2</sup> 0.5-4

4 x 1.5 mm<sup>2</sup>



24-10 AWG | 24-10 AWG | 4 mm<sup>2</sup>

Max 0.6 Nm

A4

### Cat. No.

**6800014** – 72 mm (L) x  
55 mm (H) x 1.5 mm (W)

**6800080** – 36 mm (L) x  
14 mm (H) x 6 mm (W)

**6804150** – 58 mm (L) x  
36 mm (H) x 9 mm (W)

**6302000**  
**T 2.5/5.3**  
*Feed Through*

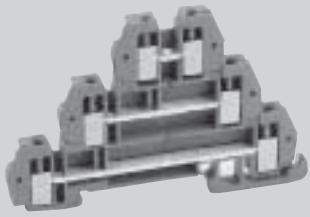

78.5 mm (L) x 47.5 mm (H) x 5.3 mm (W)

7 mm

Solid conductors mm<sup>2</sup> 0.5-4  
 Stranded conductors mm<sup>2</sup> 0.5-2.5

2 x 1.5 mm<sup>2</sup>



26-14 AWG 26-14 AWG 2.5 mm<sup>2</sup>

300V 300V 250V

10A 10A 24A

Max. 0.5 Nm

A2

**Cat. No.**

**6302000** – Gray

**6800015** – 55.4 mm (L) x 50 mm (H) x 1.5 mm (W)

- 6800192** – 100 pieces
- 6800193** – 100 pieces
- 6800194** – 100 pieces
- 6800200** – 10 pieces
- 6800202** – 100 pieces
- 6800203** – 100 pieces
- 6800204** – 100 pieces
- 6800300** – 10 pieces

**6804150** – 58 mm (L) x 36 mm (H) x 9 mm (W)

**6302100**  
**T 2.5/5.3**

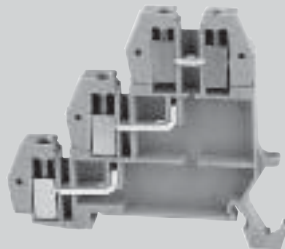

62 mm (L) x 47.5 mm (H) x 5.3 mm (W)

7 mm

Solid conductors mm<sup>2</sup> 0.5-4  
 Stranded conductors mm<sup>2</sup> 0.5-2.5

2 x 1.5 mm<sup>2</sup>



26-14 AWG 26-14 AWG 2.5 mm<sup>2</sup>

300V 300V 250V

10A 10A 24A

Max. 0.5 Nm

A2

**Cat. No.**

**6302100** – Gray

**6800016** – 55.4 mm (L) x 50 mm (H) x 1.5 mm (W)

- 6800192** – 100 pieces
- 6800193** – 100 pieces
- 6800194** – 100 pieces
- 6800200** – 10 pieces
- 6800202** – 100 pieces
- 6800203** – 100 pieces
- 6800204** – 100 pieces
- 6800300** – 10 pieces

**6804150** – 58 mm (L) x 36 mm (H) x 9 mm (W)

**6302110**  
**T 2.5/5.3**  
*PNP LED Sensor*

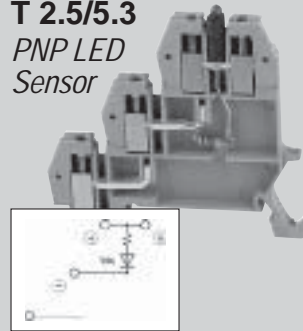

62 mm (L) x 47.5 mm (H) x 5.3 mm (W)

7 mm

Solid conductors mm<sup>2</sup> 0.5-4  
 Stranded conductors mm<sup>2</sup> 0.5-2.5

2 x 1.5 mm<sup>2</sup>



26-14 AWG 26-14 AWG 2.5 mm<sup>2</sup>

Max. 0.5 Nm

A2

**Cat. No.**

**6302110** – Gray

**6800016** – 55.4 mm (L) x 50 mm (H) x 1.5 mm (W)

- 6800192** – 100 pieces
- 6800193** – 100 pieces
- 6800194** – 100 pieces
- 6800200** – 10 pieces
- 6800202** – 100 pieces
- 6800203** – 100 pieces
- 6800204** – 100 pieces
- 6800300** – 10 pieces

**6804150** – 58 mm (L) x 36 mm (H) x 9 mm (W)

**6302120**  
**T 2.5/5.3**  
*NPN LED Sensor*

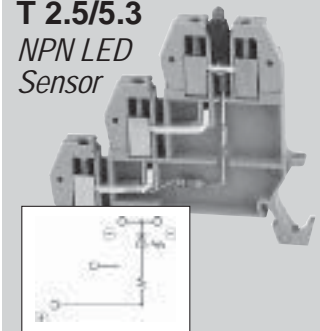

62 mm (L) x 42.5 mm (H) x 5.3 mm (W)

7 mm

Solid conductors mm<sup>2</sup> 0.5-4  
 Stranded conductors mm<sup>2</sup> 0.5-2.5

2 x 1.5 mm<sup>2</sup>



26-14 AWG 26-14 AWG 2.5 mm<sup>2</sup>

Max 0.5 Nm

A2

**Cat. No.**

**6302120** – Gray

**6800016** – 55.4 mm (L) x 50 mm (H) x 1.5 mm (W)

- 6800192** – 100 pieces
- 6800193** – 100 pieces
- 6800194** – 100 pieces
- 6800200** – 10 pieces
- 6800202** – 100 pieces
- 6800203** – 100 pieces
- 6800204** – 100 pieces
- 6800300** – 10 pieces

**6804150** – 58 mm (L) x 36 mm (H) x 9 mm (W)