

NOTES:

- 1) MATERIALS:
HOUSING - LIQUID CRYSTAL POLYMER, UL94 V-0
WAFER DIELECTRIC - LIQUID CRYSTAL POLYMER, UL94 V-0
CONTACT - COPPER ALLOY
- 2) FINISHES: SEE SHEET 2
- 3) PRODUCT SPECIFICATION: THIS PART CONFORMS TO MOLEX SPECIFICATION PS-75018-001.
- 4) PACKAGING SPECIFICATION: THIS PART TO BE PACKAGED PER SPECIFICATION PK-75020-030.
- 5) APPLICATION SPECIFICATION: THIS PART TO BE APPLIED PER SPECIFICATION PS-75018-001. APPLICATION TOOL AND INSTRUCTIONS PER AS-75018-001.
- 6) MATING INFORMATION
THIS PART MATES WITH 75019-XXXX.
WILL MATE WITH MAXIMUM 1.27mm MIS-ALIGNMENT.
WILL MATE WITH MAXIMUM 0.5° MIS-ALIGNMENT.
- 7) FOR CIRCUIT DESIGNATION SEE SHEET 3
- 8) FOR PCB INFORMATION SEE SHEET 3
- 9) CIRCUITS IN THIS ZONE HAVE BEEN OMITTED TO SIMPLIFY THE MODEL. ACTUAL PRODUCT IS FULLY LOADED WITH TERMINALS.
- 10) APPLICATION TOOLING KEEP OUT AREA. NO COMPONENTS ALLOWED IN THIS AREA.
- 11) CONFORMS TO MOLEX COSMETIC SPECIFICATION PS-45499-002 & PS-45499-003, CLASS C.
- 12) MARKING: PART NUMBER, MOLEX LOGO, DATE CODE
- 13) RECOMMENDED DRILL SIZE 0.66±0.03 TO YIELD FINISHED PLATED THROUGH HOLE OF 0.55±0.05

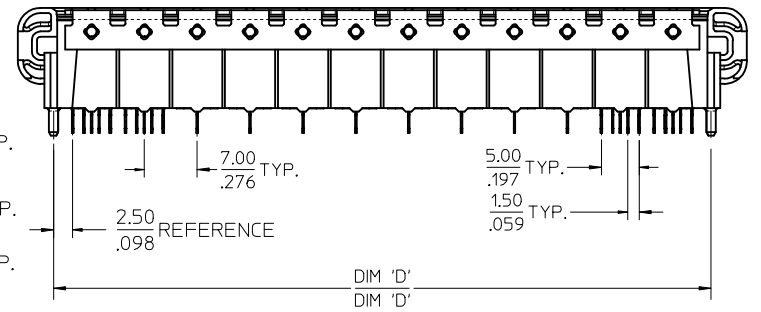
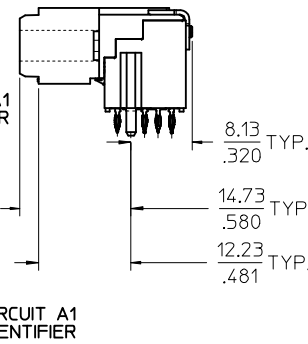
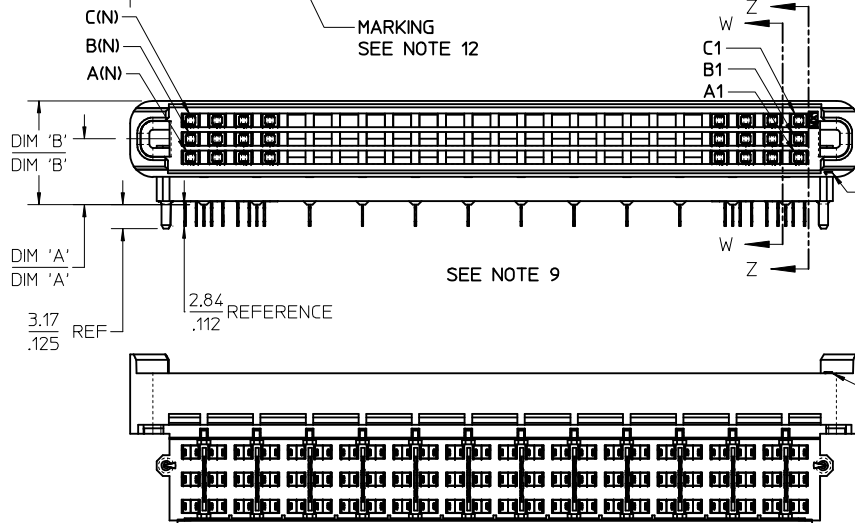
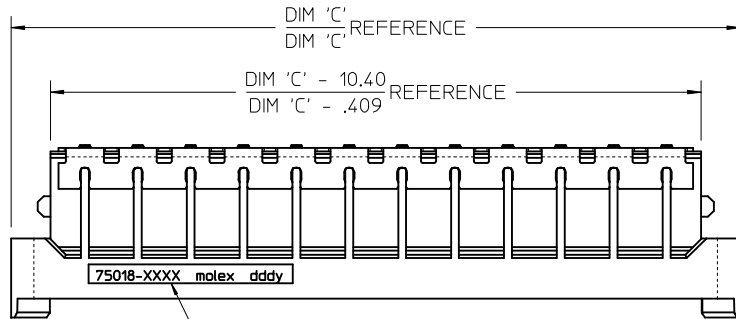

CLARIFY DIMENSIONS EC NO: UCP2016-2525 DRWN: TIBARRA 2015/12/18 CHKD: MCAN 2015/12/18 APPR: SMILLER 2015/12/18 REV:	QUALITY SYMBOLS ▽=0 ▽=0 ▽=0	GENERAL TOLERANCES (UNLESS SPECIFIED) <table border="1"> <thead> <tr> <th></th> <th>mm</th> <th>INCH</th> </tr> </thead> <tbody> <tr> <td>4 PLACES</td> <td>± .15</td> <td>± .005</td> </tr> <tr> <td>3 PLACES</td> <td>± .10</td> <td>± .005</td> </tr> <tr> <td>2 PLACES</td> <td>± 0.13</td> <td>± .01</td> </tr> <tr> <td>1 PLACE</td> <td>± 0.25</td> <td>± .01</td> </tr> <tr> <td>0 PLACE</td> <td>±</td> <td>±</td> </tr> </tbody> </table>		mm	INCH	4 PLACES	± .15	± .005	3 PLACES	± .10	± .005	2 PLACES	± 0.13	± .01	1 PLACE	± 0.25	± .01	0 PLACE	±	±	DIMENSION STYLE MM/IN DRAWN BY: RWHIPPLE DATE: 2013/11/05 CHECKED BY: _____ DATE: _____ APPROVED BY: SMILLER DATE: 2013/11/19 MATERIAL NO.	SCALE 2:1 DESIGN UNITS METRIC THIRD ANGLE PROJECTION	TITLE PLATEAU HS DOCK FIXED CONNECTOR NO GROUND FINGER molex	SHEET NO. 1 OF 3
		mm	INCH																					
	4 PLACES	± .15	± .005																					
	3 PLACES	± .10	± .005																					
2 PLACES	± 0.13	± .01																						
1 PLACE	± 0.25	± .01																						
0 PLACE	±	±																						
DRAFT WHERE APPLICABLE MUST REMAIN WITHIN DIMENSIONS		SIZE C	DOCUMENT NO. SD-75018-5000																					
THIS DRAWING CONTAINS INFORMATION THAT IS PROPRIETARY TO MOLEX INCORPORATED AND SHOULD NOT BE USED WITHOUT WRITTEN PERMISSION																								

ITEM NUMBER	CIRCUIT SIZE	NO. OF COLUMNS 'N'	PLATING FINISH	CENTERLINE DIMENSION 'A' mm(in)	O/A HEIGHT DIMENSION 'B' mm(in)	O/A LENGTH DIMENSION 'C' mm(in)	PEG TO PEG DIMENSION 'D' mm(in)	FIRST-LAST DIMENSION 'E' mm(in)
75018-5021	144	24	FINISH 1	4.74 (.187)	9.78 (.385)	96.50 (3.799)	87.00 (3.425)	82.00 (3.228)
75018-5022	144	24	FINISH 1	5.74 (.226)	10.78 (.424)	96.50 (3.799)	87.00 (3.425)	82.00 (3.228)
75018-5023	144	24	FINISH 1	8.74 (.344)	13.78 (.543)	96.50 (3.799)	87.00 (3.425)	82.00 (3.228)
75018-5024	108	18	FINISH 1	4.74 (.187)	9.78 (.385)	75.50 (2.972)	66.00 (2.598)	61.00 (2.402)
75018-5025	108	18	FINISH 1	8.74 (.344)	13.78 (.543)	75.50 (2.972)	66.00 (2.598)	61.00 (2.402)
75018-5026	120	20	FINISH 1	4.74 (.187)	9.78 (.385)	82.50 (3.248)	73.00 (2.874)	68.00 (2.677)
75018-5027	108	18	FINISH 1	5.74 (.226)	10.78 (.424)	75.50 (2.972)	66.00 (2.598)	61.00 (2.402)
75018-5029	120	20	FINISH 1	5.74 (.226)	10.78 (.424)	82.50 (3.248)	73.00 (2.874)	68.00 (2.677)
75018-5221	144	24	FINISH 2	4.74 (.187)	9.78 (.385)	96.50 (3.799)	87.00 (3.425)	82.00 (3.228)
75018-5224	108	18	FINISH 2	4.74 (.187)	9.78 (.385)	75.50 (2.972)	66.00 (2.598)	61.00 (2.402)

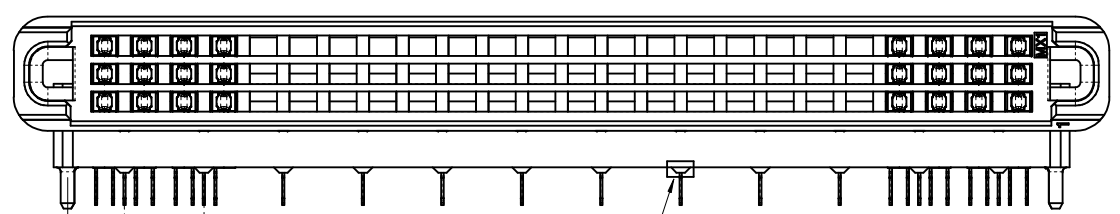

5.00
.197 REFERENCE

7.00
.276 REFERENCE TYPICAL

SEE DETAIL A

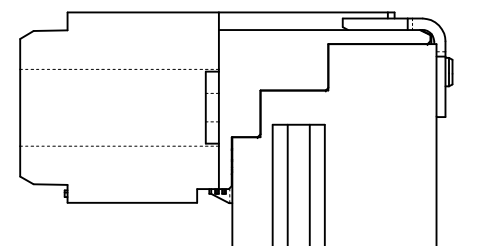

3.38
.133 REFERENCE TYPICAL

6.98
.275 REFERENCE TYPICAL

SEE DETAIL B

SEE DETAIL C

1) PLATING FINISHES:

FINISH 1:

CONTACT INTERFACE

0.76 MICROMETERS/30 MICROINCHES MINIMUM SELECT GOLD
NICKEL UNDERPLATE OVERALL

COMPLIANT INTERFACE

0.76 MICROMETERS/30 MICROINCHES MINIMUM SELECT MATTE-TIN OVER
NICKEL UNDERPLATE OVERALL

HOUSING

3.81 MICROMETERS/150 MICROINCHES MINIMUM NICKEL OVER
COPPER UNDERPLATE OVERALL

FINISH 2:

CONTACT INTERFACE

0.76 MICROMETERS/30 MICROINCHES MINIMUM SELECT GOLD
NICKEL UNDERPLATE OVERALL

COMPLIANT INTERFACE

0.76 MICROMETERS/30 MICROINCHES MINIMUM SELECT MATTE-TIN OVER
NICKEL UNDERPLATE OVERALL

HOUSING

0.10 MICROMETERS/4 MICROINCHES MAXIMUM GOLD OVER
3.81 MICROMETERS/150 MICROINCHES MINIMUM NICKEL OVER
COPPER UNDERPLATE OVERALL

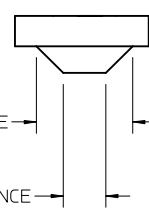

1.70
.067 REFERENCE TYPICAL

0.75
.030 REFERENCE TYPICAL

DETAIL A
SCALE 15:1

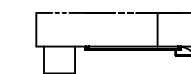

0.55
.022 REFERENCE TYPICAL

DETAIL B
SCALE 15:1

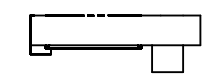

0.55
.022 REFERENCE TYPICAL

DETAIL C
SCALE 15:1

SEE SHEET 1 EC NO: UCP2016-2525 DRWN: TIBARRA 2015/12/18 CHK: MCAN 2015/12/18 APPR: MILLER 2015/12/22	QUALITY SYMBOLS ∇=0 ∇=0 ∇=0	GENERAL TOLERANCES (UNLESS SPECIFIED)		DIMENSION STYLE	SCALE	DESIGN UNITS	THIRD ANGLE PROJECTION	
		mm	INCH	MM/IN	3:1	METRIC	☉	
		DRAWN BY DATE		CHECKED BY DATE		PLATEAU HS DOCK FIXED CONNECTOR NO GROUND FINGER molex		
		APPROVED BY DATE		MATERIAL NO.				
DRAFT WHERE APPLICABLE MUST REMAIN WITHIN DIMENSIONS		SEE TABLE SIZE C		SD-75018-5000		2 OF 3		
THIS DRAWING CONTAINS INFORMATION THAT IS PROPRIETARY TO MOLEX INCORPORATED AND SHOULD NOT BE USED WITHOUT WRITTEN PERMISSION								

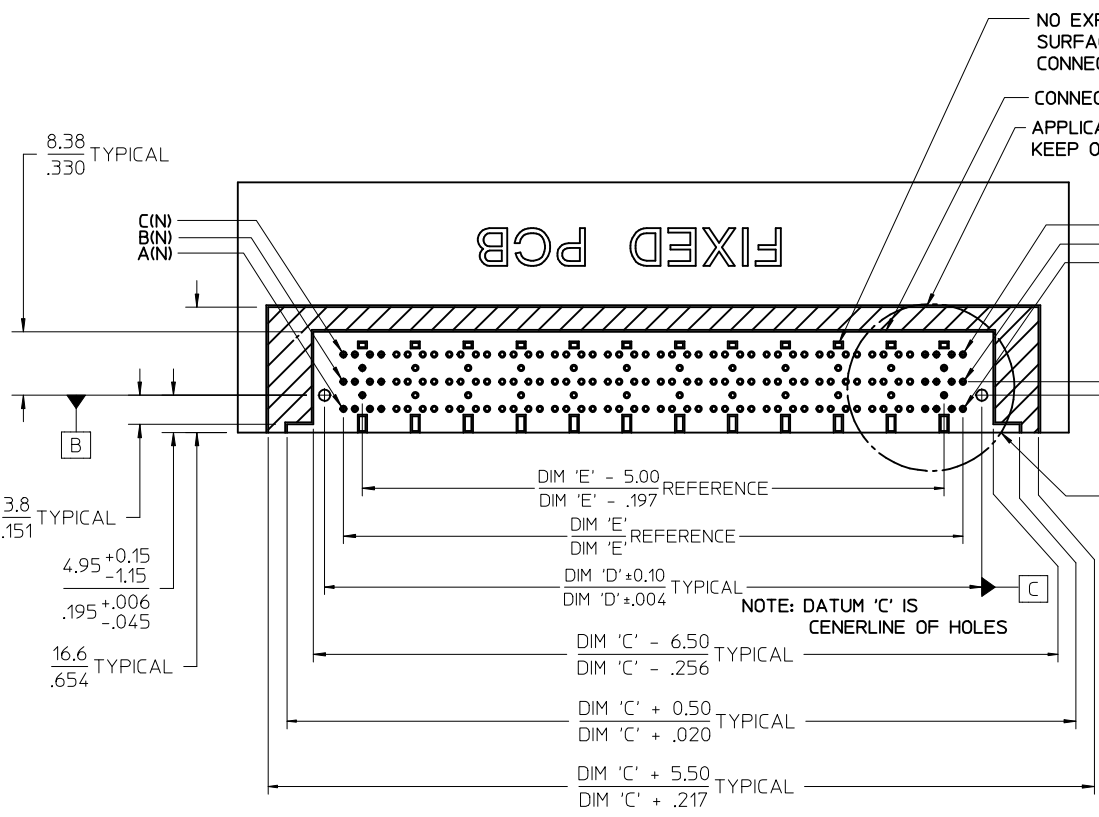

NO EXPOSED TRACES ON SURFACE OF PCB IN CONNECTOR STAND OFF LOCATIONS
 CONNECTOR KEEP OUT AREA
 APPLICATION TOOLING KEEP OUT AREA (NOTES 5 & 10)

CIRCUIT DESIGNATION
 FIRST MATE: HOUSING - SIGNAL GROUND
 SECOND MATE: A1, C1, A(N), C(N) (FOR POWER RETURN)
 THIRD MATE: A2, B2, C2, A(N-1), B(N-1), C(N-1) & ALL OTHERS (A2, C2, A(N-1) & C(N-1) FOR POWER) (ALL OTHERS SIGNAL)
 LAST MATE: B1, B(N) (FOR CARD DETECT)
 ALL COLUMNS FROM 3 THROUGH (N-2) ARE SUITABLE FOR DIFFERENTIAL PAIRS
 EG: A3-A4, B3-B4, C3-C4, A(N-2)-A(N-3), B(N-2)-B(N-3)
 SIGNAL GROUND: ROWS D & E

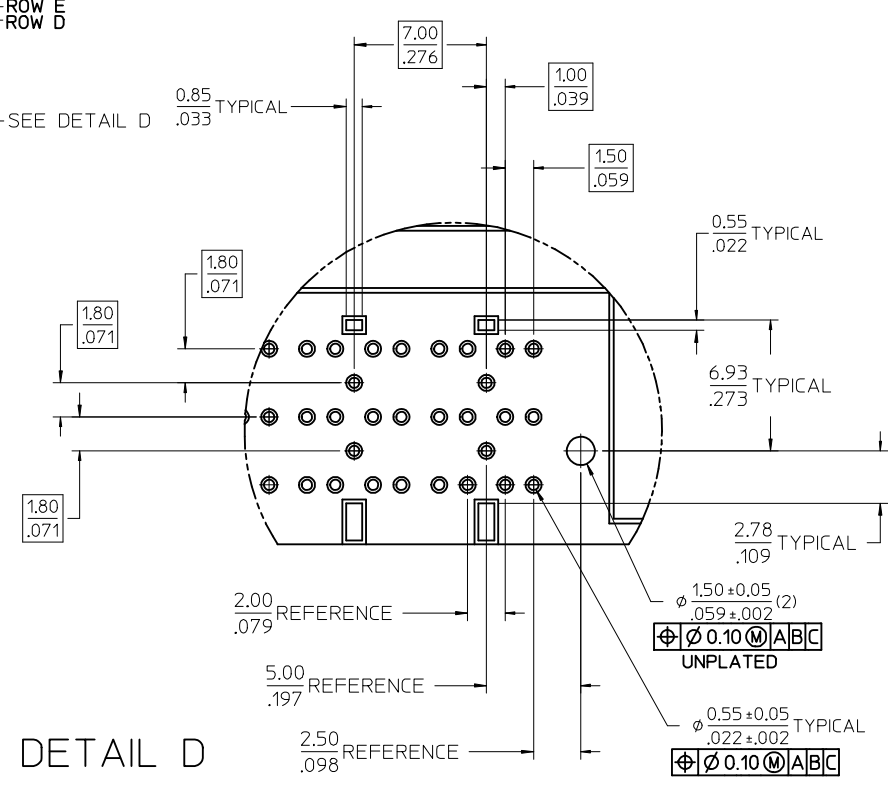

NOMINAL WIPE - FULL SEATED
 FIRST MATE: 7.2mm
 SECOND MATE: 2.4mm
 THIRD MATE: 1.9mm
 LAST MATE: 1.4mm

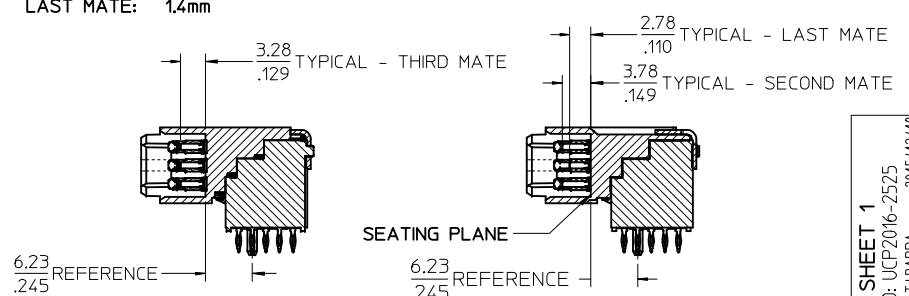

DETAIL D
 SCALE 5:1

SEE SHEET 1 EC NO: UCP2016-2525 DRWN: TIBARRA 2015/12/18 CHKD: MCAN 2015/12/18 APPR: MILLER 2015/12/17	QUALITY SYMBOLS ∇=0 ∇=0 ∇=0	GENERAL TOLERANCES (UNLESS SPECIFIED)		DIMENSION STYLE MM/IN	SCALE 2:1	DESIGN UNITS METRIC	THIRD ANGLE PROJECTION		
		4 PLACES ± --- ± --- 3 PLACES ± --- ± .005 2 PLACES ± 0.13 ± .01 1 PLACE ± 0.25 ± --- 0 PLACE ± ±	mm INCH ± --- ± --- ± .005 ± .01 ± --- ± --- ± ±	DRAWN BY RWHIPPLE	DATE 2013/11/05	TITLE PLATEAU HS DOCK FIXED CONNECTOR NO GROUND FINGER			
		ANGULAR ±1/2° DRAFT WHERE APPLICABLE MUST REMAIN WITHIN DIMENSIONS		APPROVED BY MILLER	DATE 2013/11/19	DOCUMENT NO. SD-75018-5000			
		MATERIAL NO. SEE TABLE		SHEET NO. 3 OF 3		THIS DRAWING CONTAINS INFORMATION THAT IS PROPRIETARY TO MOLEX INCORPORATED AND SHOULD NOT BE USED WITHOUT WRITTEN PERMISSION			