

RECEPTACLE

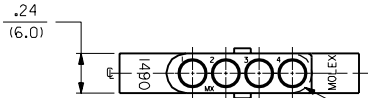

ALTERNATE CONFIGURATION

OPTIONAL MOUNTING EAR (2 PL.)
(STD. MOUNTING EAR SHOWN)
SEE DETAIL 3 OR 4

CIRCUIT I.D.

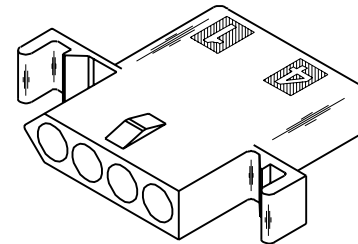
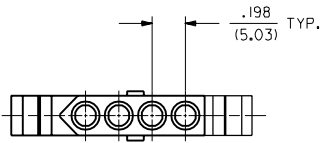
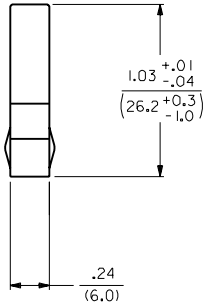
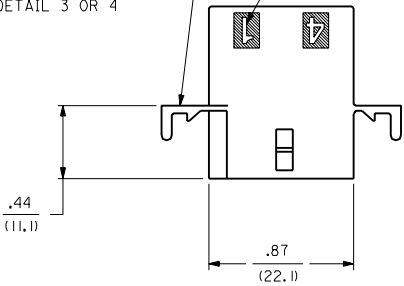

RECEPTACLE HOUSING

DIMENSIONS SHOWN (METRIC) INCH		UNLESS OTHERWISE SPECIFIED TOLERANCES: ANGULAR ± .004 TO		REVISIONS		REVISIONS		REVISIONS		REVISIONS		REVISIONS		REVISIONS		REVISIONS		REVISIONS	
INCH	METRIC	INCH	METRIC	NO.	DATE	BY	CHKD.	APP'D.	SCALE	FILE NAME	DRWG. NO.	SHEET NO.	DATE	U.S.A.	CP	SIZE	CP	CP	CP
3 PLACE ± .010	---			T		SEE SHT. 1													
2 PLACE ± .014	± 0.25			S		SEE SHT. 1													
1 PLACE ---	± 0.35			R		SEE SHT. 1													
				P		SEE SHT. 1													
				LTR.		REVISIONS													

DIMENSIONS SHOWN (METRIC) INCH $\nabla = 0$ $\blacktriangledown = 0$ **REVISE ONLY ON CAD SYSTEM**
 TITLE: **.093/(2.36) HOUSING, PLUG AND RECEPTACLE, 4 CKT. ± .198/(5.03) CTRS.**
MOLEX INCORPORATED LITSEJLL 60532 U.S.A.
 SHEET NO. 2 DATE 3/10/88
SEE CHART DRWG. NO. **SD-1490-***
 FILE NAME: SD1490X2.DWG
 THIS DRAWING CONTAINS INFORMATION THAT IS PROPRIETARY TO MOLEX INC. AND SHOULD NOT BE USED WITHOUT WRITTEN PERMISSION.

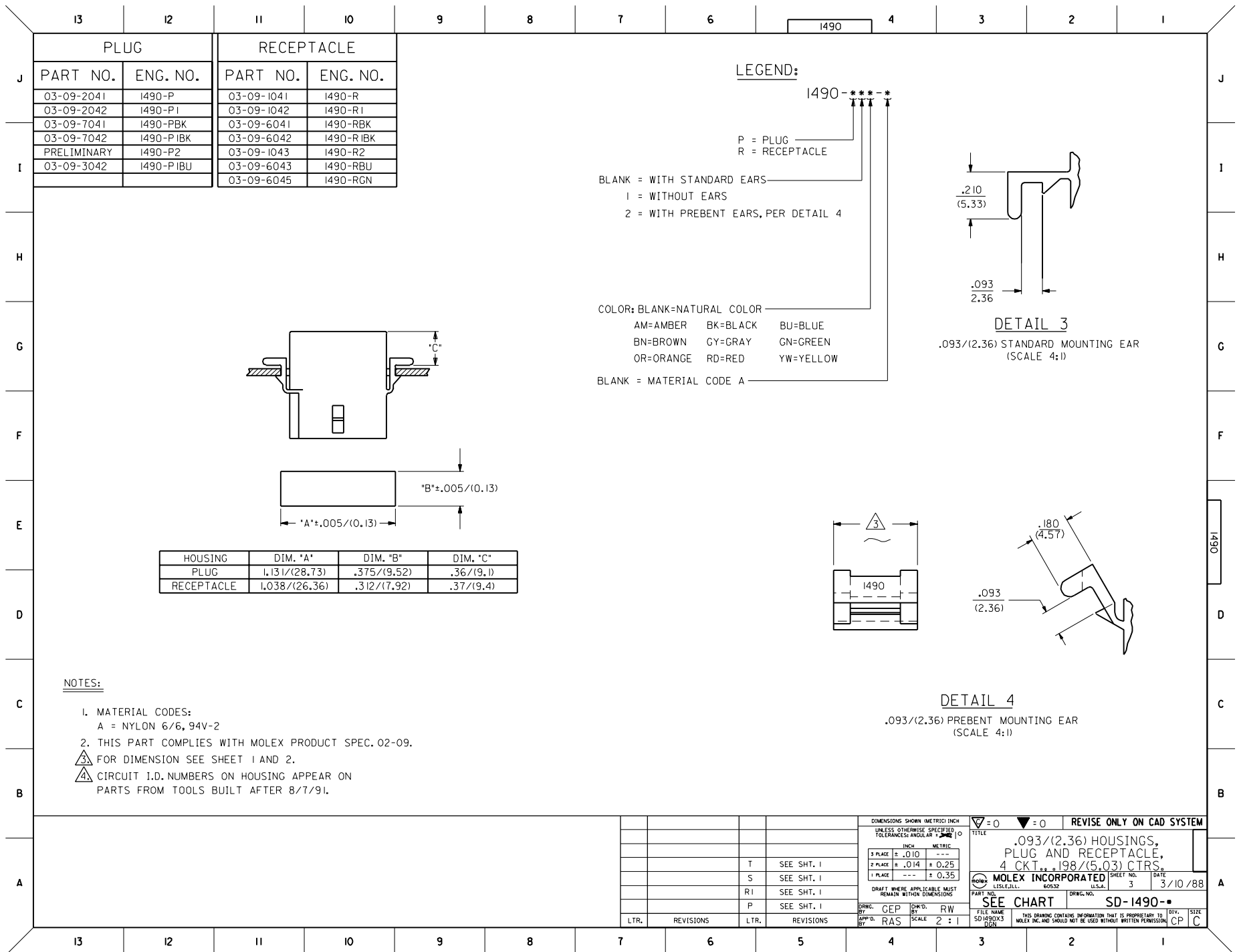

13 12 11 10 9 8 7 6 5 4 3 2 1

I490

I490-***-*

LEGEND:

P = PLUG
R = RECEPTACLE

BLANK = WITH STANDARD EARS
1 = WITHOUT EARS
2 = WITH PREBENT EARS, PER DETAIL 4

COLOR: BLANK=NATURAL COLOR
AM=AMBER BK=BLACK BU=BLUE
BN=BROWN CY=GRAY GN=GREEN
OR=ORANGE RD=RED YW=YELLOW
BLANK = MATERIAL CODE A

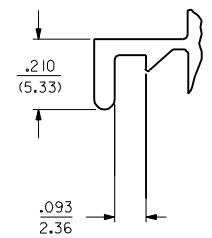

DETAIL 3

.093/(2.36) STANDARD MOUNTING EAR (SCALE 4:1)

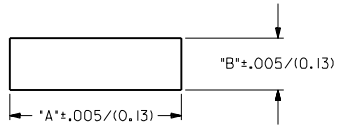
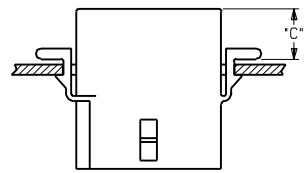

HOUSING	DIM. "A"	DIM. "B"	DIM. "C"
PLUG	1.131/(28.73)	.375/(9.52)	.36/(9.1)
RECEPTACLE	1.038/(26.36)	.312/(7.92)	.37/(9.4)

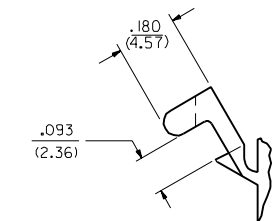
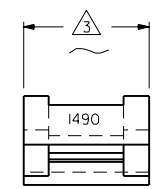

DETAIL 4

.093/(2.36) PREBENT MOUNTING EAR (SCALE 4:1)

NOTES:

- MATERIAL CODES:
A = NYLON 6/6, 94V-2
- THIS PART COMPLIES WITH MOLEX PRODUCT SPEC. 02-09.
- FOR DIMENSION SEE SHEET 1 AND 2.
- CIRCUIT I.D. NUMBERS ON HOUSING APPEAR ON PARTS FROM TOOLS BUILT AFTER 8/7/91.

DIMENSIONS SHOWN (METRIC) INCH
UNLESS OTHERWISE SPECIFIED
TOLERANCES: ANGLES .01° ± .001°

	INCH	METRIC
3 PLACE	± .010	---
2 PLACE	± .014	± 0.25
1 PLACE	---	± 0.35

DRAFT WHERE APPLICABLE MUST REMAIN WITHIN DIMENSIONS

▽=0 ▼=0 **REVISE ONLY ON CAD SYSTEM**

TITLE
.093/(2.36) HOUSINGS,
PLUG AND RECEPTACLE,
4 CKT., .198/(5.03) CTRS.

MOLEX INCORPORATED
LITTLE ROCK, AR 60532 U.S.A.
SHEET NO. 3 DATE 3/10/88

PART NO. SD-1490-#
SEE CHART DRWG. NO.

FILE NAME: SD1490X3.DGN
THIS DRAWING CONTAINS INFORMATION THAT IS PROPRIETARY TO MOLEX INC. AND SHOULD NOT BE USED WITHOUT WRITTEN PERMISSION.
DWN. BY: CEP
APP'D. BY: RAS
CHK'D. BY: RW
SCALE: 2:1
DWN. BY: CP
SIZE: C

LTR.	REVISIONS	LTR.	REVISIONS
	T	SEE SHT. 1	
	S	SEE SHT. 1	
	RI	SEE SHT. 1	
	P	SEE SHT. 1	

13 12 11 10 9 8 7 6 5 4 3 2 1