



RF Power Field Effect Transistors

N-Channel Enhancement-Mode Lateral MOSFETs

Designed for W-CDMA base station applications with frequencies from 2110 to 2170 MHz. Suitable for TDMA, CDMA and multicarrier amplifier applications. To be used in Class AB for PCN-PCS/cellular radio and WLL applications.

- Typical Single-Carrier W-CDMA Performance: $V_{DD} = 28$ Volts, $I_{DQ} = 1600$ mA, $P_{out} = 54$ Watts Avg., Full Frequency Band, 3GPP Test Model 1, 64 DPCH with 50% Clipping, Channel Bandwidth = 3.84 MHz, Input Signal PAR = 7.5 dB @ 0.01% Probability on CCDF.
 Power Gain — 16 dB
 Drain Efficiency — 29%
 Device Output Signal PAR — 6.1 dB @ 0.01% Probability on CCDF
 ACPR @ 5 MHz Offset — -38 dBc in 3.84 MHz Channel Bandwidth
- Capable of Handling 10:1 VSWR, @ 32 Vdc, 2140 MHz, 175 Watts CW Output Power

Features

- 100% PAR Tested for Guaranteed Output Power Capability
- Characterized with Series Equivalent Large-Signal Impedance Parameters
- Internally Matched for Ease of Use
- Integrated ESD Protection
- Designed for Digital Predistortion Error Correction Systems
- Designed for Lower Memory Effects and Wide Instantaneous Bandwidth Applications
- RoHS Compliant
- In Tape and Reel. R3 Suffix = 250 Units per 56 mm, 13 inch Reel.

MRF6S21190HR3
MRF6S21190HSR3

2110-2170 MHz, 54 W AVG., 28 V
SINGLE W-CDMA
LATERAL N-CHANNEL
RF POWER MOSFETs

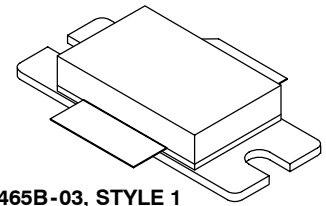

CASE 465B-03, STYLE 1
NI-880
MRF6S21190HR3

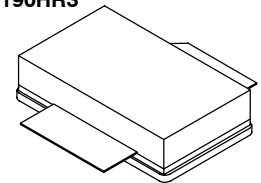

CASE 465C-02, STYLE 1
NI-880S
MRF6S21190HSR3

Table 1. Maximum Ratings

Rating	Symbol	Value	Unit
Drain-Source Voltage	V_{DSS}	-0.5, +68	Vdc
Gate-Source Voltage	V_{GS}	-0.5, +12	Vdc
Operating Voltage	V_{DD}	32, +0	Vdc
Storage Temperature Range	T_{stg}	-65 to +150	°C
Case Operating Temperature	T_C	150	°C
Operating Junction Temperature	T_J	200	°C
CW Operation @ $T_C = 25^\circ\text{C}$ Derate above 25°C	CW	175 1	W W/°C

Table 2. Thermal Characteristics

Characteristic	Symbol	Value (1,2)	Unit
Thermal Resistance, Junction to Case Case Temperature 85°C, 120 W CW Case Temperature 83°C, 56 W CW	$R_{\theta JC}$	0.29 0.30	°C/W

1. MTTF calculator available at <http://www.freescale.com/rf>. Select Software & Tools/Development Tools/Calculators to access MTTF calculators by product.
2. Refer to AN1955, *Thermal Measurement Methodology of RF Power Amplifiers*. Go to <http://www.freescale.com/rf>. Select Documentation/Application Notes - AN1955.

Table 3. ESD Protection Characteristics

Test Methodology	Class
Human Body Model (per JESD22-A114)	1B (Minimum)
Machine Model (per EIA/JESD22-A115)	A (Minimum)
Charge Device Model (per JESD22-C101)	IV (Minimum)

Table 4. Electrical Characteristics ($T_C = 25^\circ\text{C}$ unless otherwise noted)

Characteristic	Symbol	Min	Typ	Max	Unit
----------------	--------	-----	-----	-----	------

Off Characteristics

Zero Gate Voltage Drain Leakage Current ($V_{DS} = 68 \text{ Vdc}$, $V_{GS} = 0 \text{ Vdc}$)	I_{DSS}	—	—	10	μAdc
Zero Gate Voltage Drain Leakage Current ($V_{DS} = 28 \text{ Vdc}$, $V_{GS} = 0 \text{ Vdc}$)	I_{DSS}	—	—	1	μAdc
Gate-Source Leakage Current ($V_{GS} = 5 \text{ Vdc}$, $V_{DS} = 0 \text{ Vdc}$)	I_{GSS}	—	—	1	μAdc

On Characteristics

Gate Threshold Voltage ($V_{DS} = 10 \text{ Vdc}$, $I_D = 420 \mu\text{Adc}$)	$V_{GS(th)}$	1	2	3	Vdc
Gate Quiescent Voltage ($V_{DD} = 28 \text{ Vdc}$, $I_D = 1600 \text{ mAdc}$, Measured in Functional Test)	$V_{GS(Q)}$	2	2.8	4	Vdc
Drain-Source On-Voltage ($V_{GS} = 10 \text{ Vdc}$, $I_D = 4.2 \text{ Adc}$)	$V_{DS(on)}$	0.12	0.21	0.31	Vdc

Dynamic Characteristics ⁽¹⁾

Reverse Transfer Capacitance ($V_{DS} = 28 \text{ Vdc} \pm 30 \text{ mV(rms)ac}$ @ 1 MHz, $V_{GS} = 0 \text{ Vdc}$)	C_{rss}	—	2.8	—	pF
Output Equivalent Capacitance ($V_{DS} = 28 \text{ Vdc} \pm 30 \text{ mV(rms)ac}$ @ 1 MHz, $V_{GS} = 0 \text{ Vdc}$)	C_{out}	—	185	—	pF
Input Capacitance ($V_{DS} = 28 \text{ Vdc}$, $V_{GS} = 0 \text{ Vdc} \pm 30 \text{ mV(rms)ac}$ @ 1 MHz)	C_{iss}	—	526	—	pF

Functional Tests (In Freescale Test Fixture, 50 ohm system) $V_{DD} = 28 \text{ Vdc}$, $I_{DQ} = 1600 \text{ mA}$, $P_{out} = 54 \text{ W Avg.}$, $f = 2112.5 \text{ MHz}$ and $f = 2167.5 \text{ MHz}$, Single-Carrier W-CDMA, 3GPP Test Model 1, 64 DPCH, 50% Clipping, Input Signal PAR = 7.5 dB @ 0.01% Probability on CCDF. ACPR measured in 3.84 MHz Channel Bandwidth @ $\pm 5 \text{ MHz}$ Offset.

Power Gain	G_{ps}	14.5	16	17.5	dB
Drain Efficiency	η_D	26	29	—	%
Output Peak-to-Average Ratio @ 0.01% Probability on CCDF	PAR	5.5	6.1	—	dB
Adjacent Channel Power Ratio	ACPR	—	-38	-35	dBc
Input Return Loss	IRL	—	-13	-8	dB

Typical Performances (In Freescale Test Fixture, 50 ohm system) $V_{DD} = 28 \text{ Vdc}$, $I_{DQ} = 1600 \text{ mA}$, 2110-2170 MHz Bandwidth

Video Bandwidth @ 175 W PEP P_{out} where $IM3 = -30 \text{ dBc}$ (Tone Spacing from 100 kHz to VBW) $\Delta IM3 = IM3 @ \text{VBW}$ frequency - $IM3 @ 100 \text{ kHz} < 1 \text{ dBc}$ (both sidebands)	VBW	—	50	—	MHz
Gain Flatness in 60 MHz Bandwidth @ $P_{out} = 54 \text{ W Avg.}$	G_F	—	0.16	—	dB
Average Deviation from Linear Phase in 60 MHz Bandwidth @ $P_{out} = 175 \text{ W CW}$	Φ	—	0.52	—	°
Average Group Delay @ $P_{out} = 175 \text{ W CW}$, $f = 2140 \text{ MHz}$	Delay	—	2.1	—	ns
Part-to-Part Insertion Phase Variation @ $P_{out} = 175 \text{ W CW}$, $f = 2140 \text{ MHz}$	$\Delta\Phi$	—	28	—	°
Gain Variation over Temperature (-30°C to $+85^\circ\text{C}$)	ΔG	—	0.016	—	dB/°C

1. Part internally matched both on input and output.

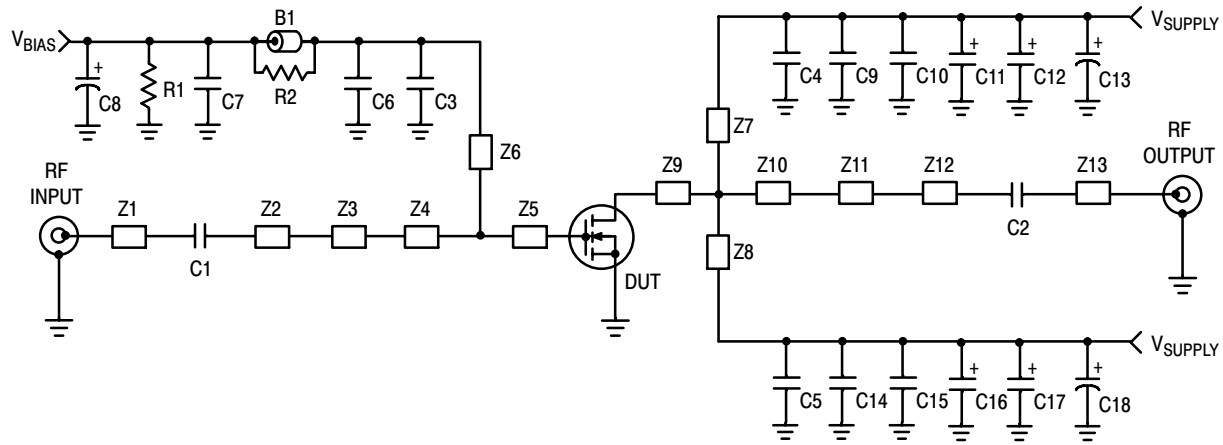

Z1	0.744" x 0.084" Microstrip	Z9	0.145" x 1.320" Microstrip
Z2	0.632" x 0.084" Microstrip	Z10	0.508" x 0.320" Microstrip
Z3	0.400" x 0.450" Microstrip	Z11	0.429" x 0.279" Microstrip
Z4	0.042" x 0.580" Microstrip	Z12	0.322" x 0.084" Microstrip
Z5	0.322" x 0.580" Microstrip	Z13	0.735" x 0.084" Microstrip
Z6	0.313" x 0.040" Microstrip	PCB	Arlon CuClad 250GX-0300-55-22, 0.030", $\epsilon_r = 2.55$
Z7, Z8	0.123" x 0.121" Microstrip		

Figure 1. MRF6S21190HR3(HSR3) Test Circuit Schematic

Table 5. MRF6S21190HR3(HSR3) Test Circuit Component Designations and Values

Part	Description	Part Number	Manufacturer
B1	Short Ferrite Bead	2743019447	Fairrite
C1, C4, C5	8.2 pF Chip Capacitors	ATC100B8R2JT500XT	ATC
C2	47 pF Chip Capacitor	ATC100B470JT500XT	ATC
C3	10 pF Chip Capacitor	ATC100B100JT500XT	ATC
C6	56 pF Chip Capacitor	ATC100B560JT500XT	ATC
C7, C9, C14	0.1 μ F Chip Capacitors	CDR33BX104AKYS	Kemet
C8	10 μ F, 50 V Electrolytic Capacitor	EMVY500ADA100MF55G	Nippon Chemi-Con
C10, C15	10 μ F Chip Capacitors	GRM55DR61H106KA88	Murata
C11, C12, C16, C17	22 μ F Tantalum Capacitors	T491X226K035AT	Kemet
C13, C18	220 μ F, 50 V Electrolytic Capacitors	EMVY500ADA221MJA0G	Nippon Chemi-Con
R1	1.0 k Ω , 1/4 W Chip Resistor	CRCW12061001FKEA	Vishay
R2	10 Ω , 1/4 W Chip Resistor	CRCW120610R0FKEA	Vishay

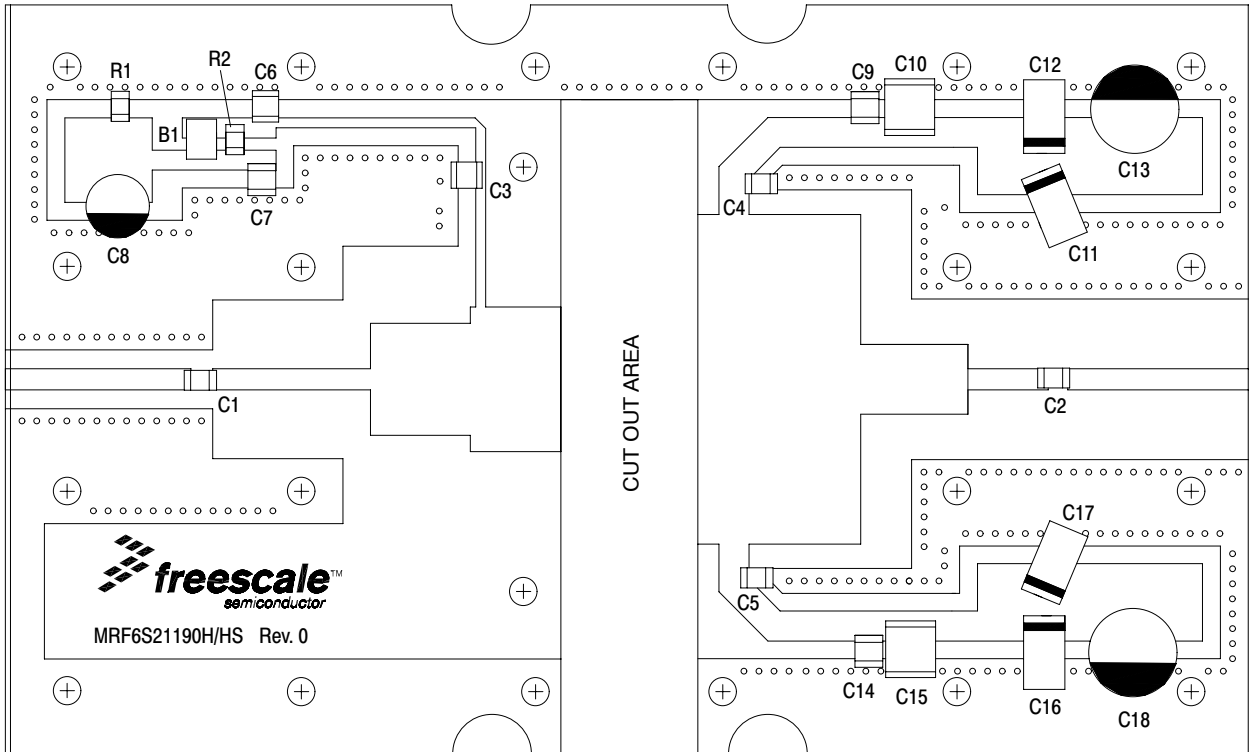

Figure 2. MRF6S21190HR3(HSR3) Test Circuit Component Layout

TYPICAL CHARACTERISTICS

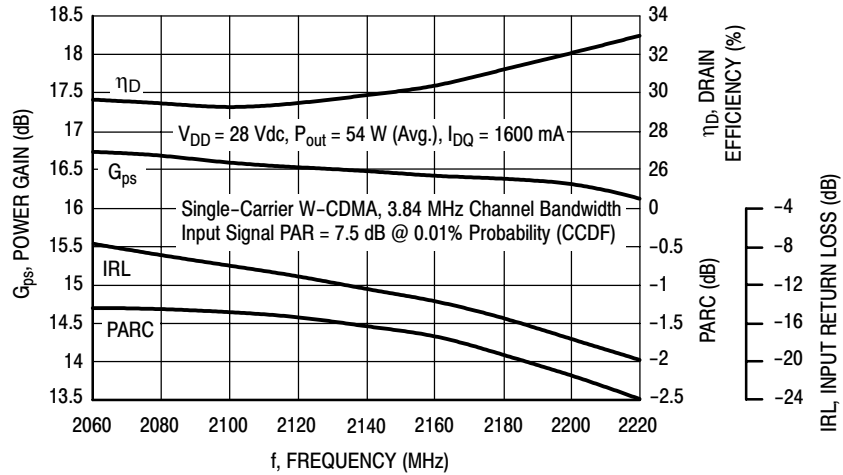

Figure 3. Output Peak-to-Average Ratio Compression (PARC) Broadband Performance @ $P_{out} = 54$ Watts Avg.

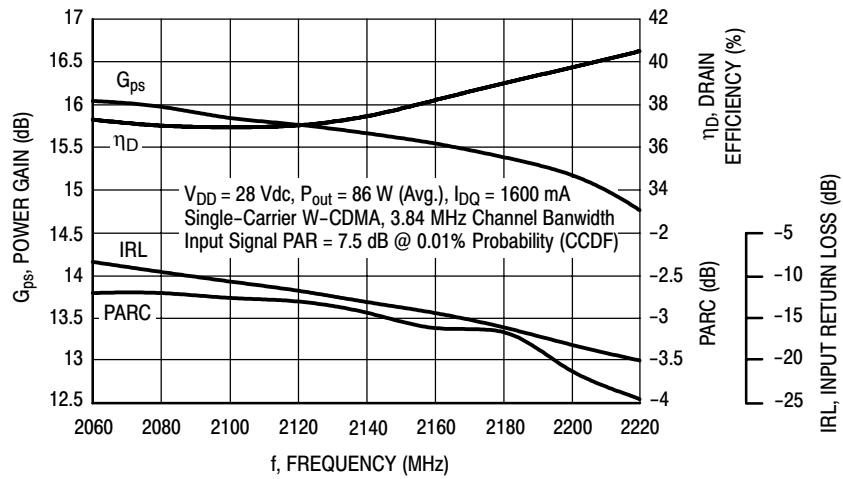

Figure 4. Output Peak-to-Average Ratio Compression (PARC) Broadband Performance @ $P_{out} = 86$ Watts Avg.

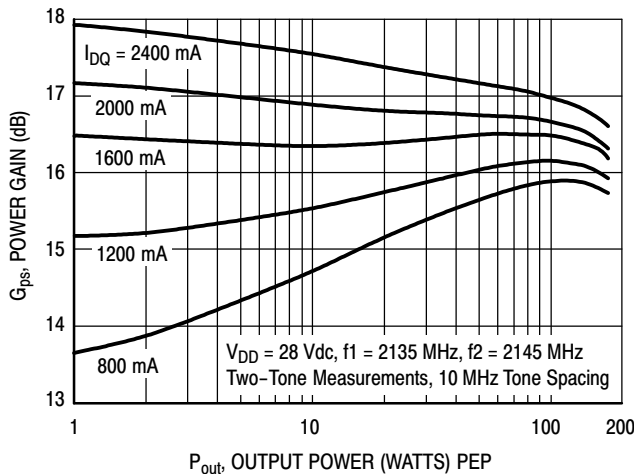

Figure 5. Two-Tone Power Gain versus Output Power

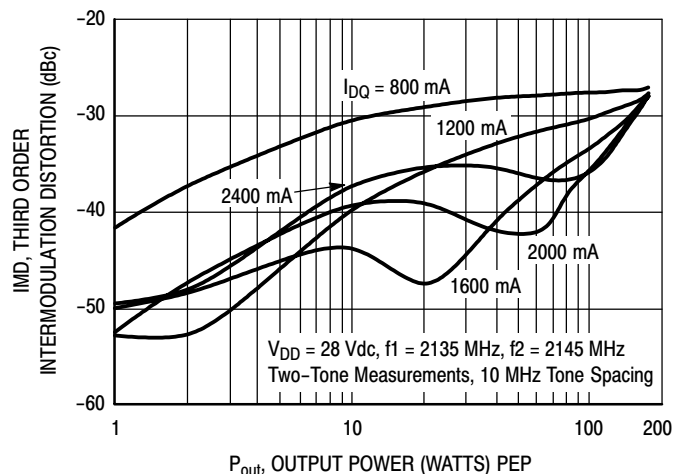

Figure 6. Third Order Intermodulation Distortion versus Output Power

TYPICAL CHARACTERISTICS

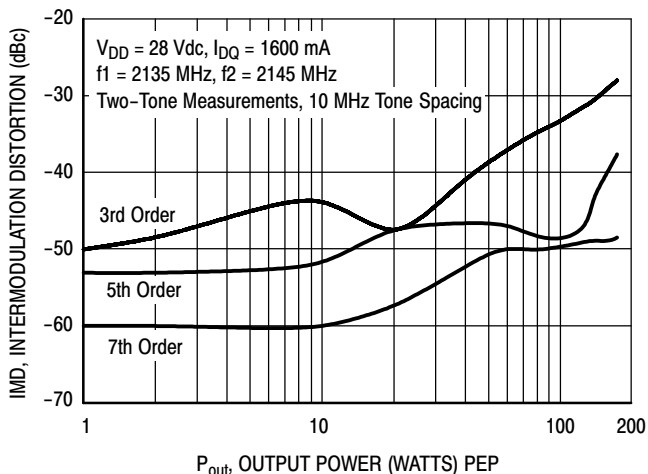

Figure 7. Intermodulation Distortion Products versus Output Power

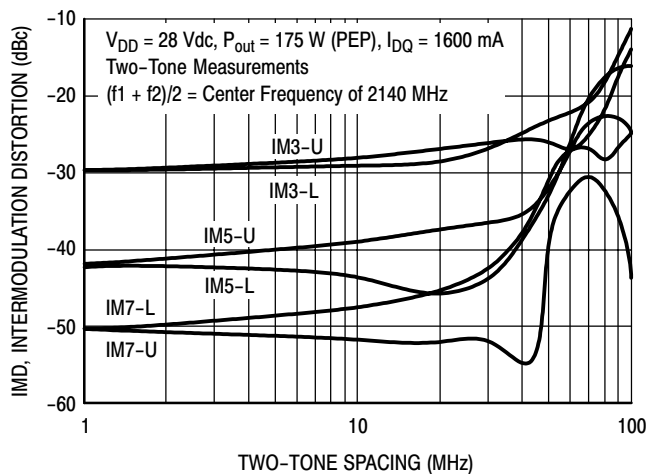

Figure 8. Intermodulation Distortion Products versus Tone Spacing

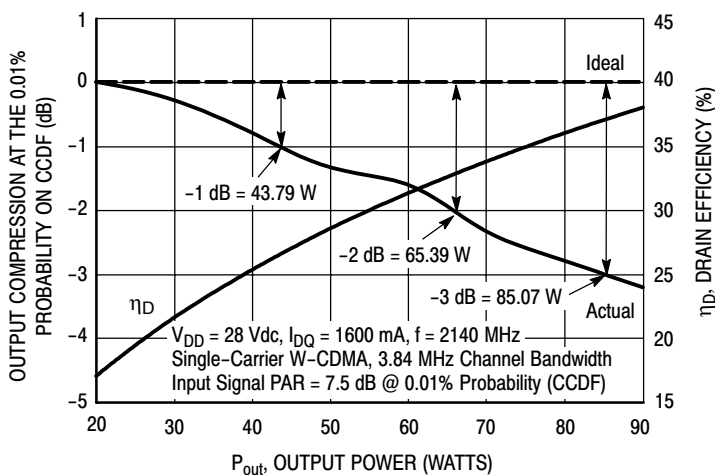

Figure 9. Output Peak-to-Average Ratio Compression (PARC) versus Output Power

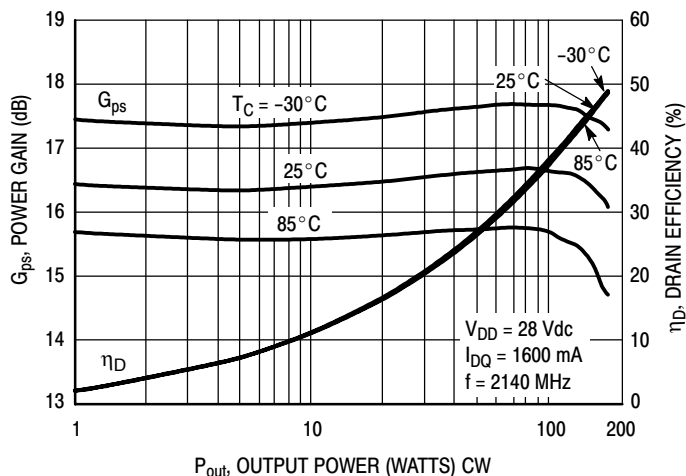

Figure 10. Power Gain and Drain Efficiency versus CW Output Power

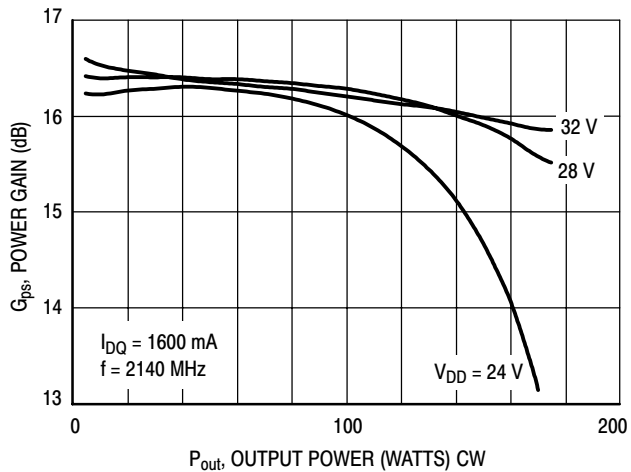
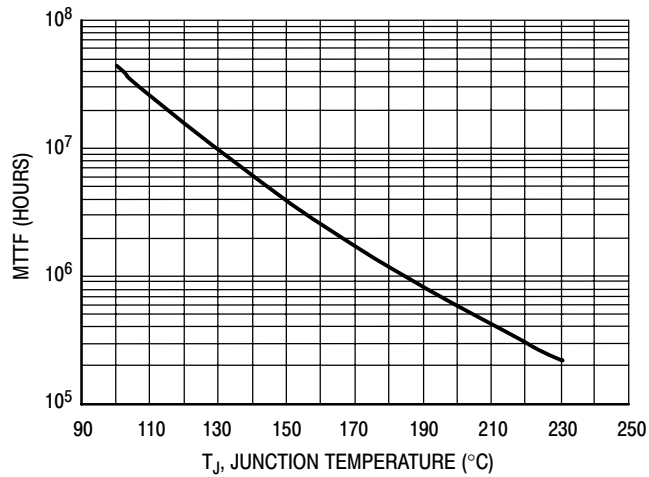

Figure 11. Power Gain versus Output Power

TYPICAL CHARACTERISTICS



This above graph displays calculated MTTF in hours when the device is operated at $V_{DD} = 28$ Vdc, $P_{out} = 54$ W Avg., and $\eta_D = 29\%$.

MTTF calculator available at <http://www.freescale.com/rf>. Select Software & Tools/Development Tools/Calculators to access MTTF calculators by product.

Figure 12. MTTF versus Junction Temperature

W-CDMA TEST SIGNAL

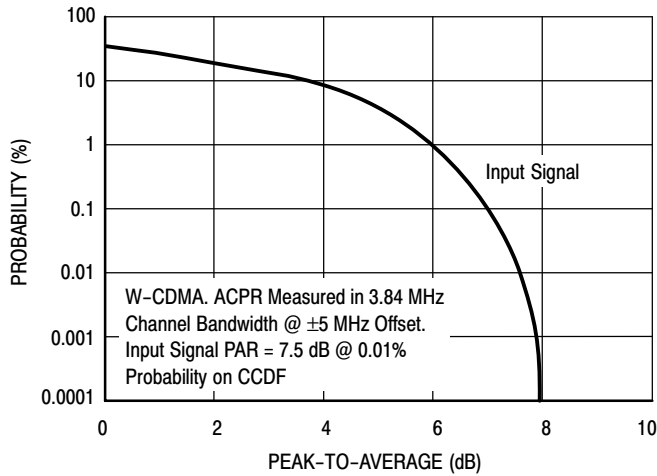

Figure 13. CCDF W-CDMA 3GPP, Test Model 1, 64 DPCH, 50% Clipping, Single-Carrier Test Signal

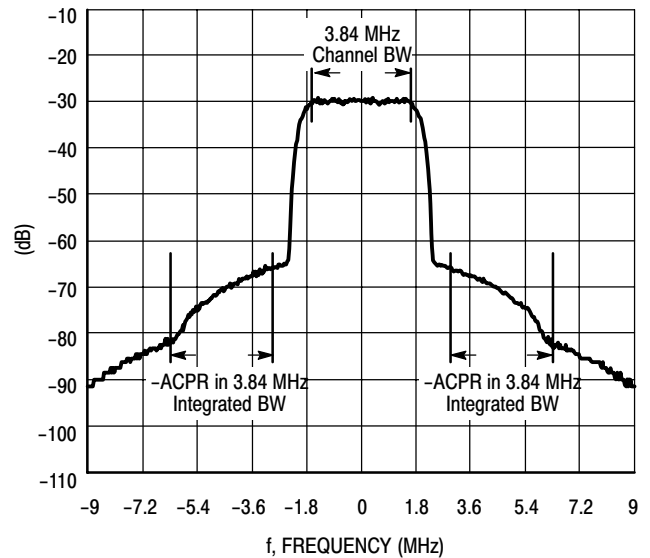
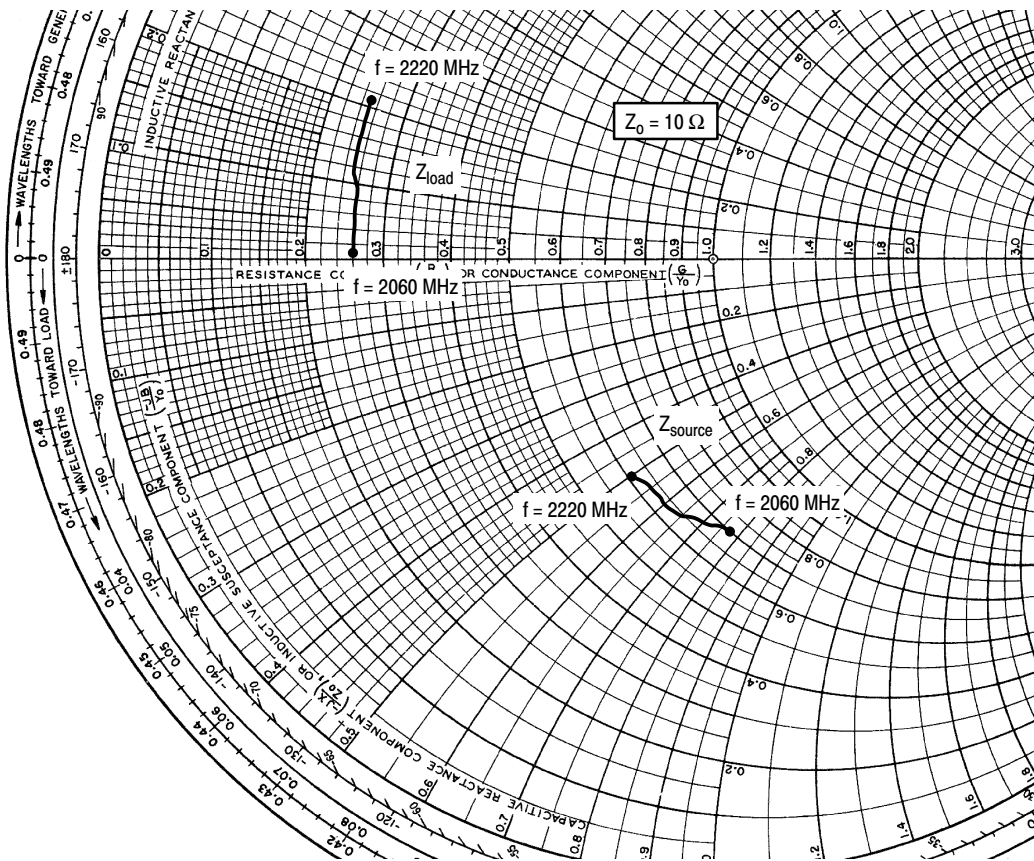

Figure 14. Single-Carrier W-CDMA Spectrum



$V_{DD} = 28 \text{ Vdc}$, $I_{DQ} = 1600 \text{ mA}$, $P_{out} = 54 \text{ W Avg.}$

f MHz	Z_{source} Ω	Z_{load} Ω
2060	$7.001 - j7.706$	$2.628 + j0.118$
2080	$6.859 - j7.408$	$2.602 + j0.415$
2100	$6.710 - j7.052$	$2.604 + j0.672$
2120	$6.573 - j6.707$	$2.566 + j0.901$
2140	$6.446 - j6.355$	$2.536 + j1.175$
2160	$6.339 - j5.987$	$2.538 + j1.411$
2180	$6.251 - j5.653$	$2.547 + j1.654$
2200	$6.170 - j5.272$	$2.533 + j1.892$
2220	$6.138 - j4.974$	$2.508 + j2.119$

Z_{source} = Test circuit impedance as measured from gate to ground.

Z_{load} = Test circuit impedance as measured from drain to ground.

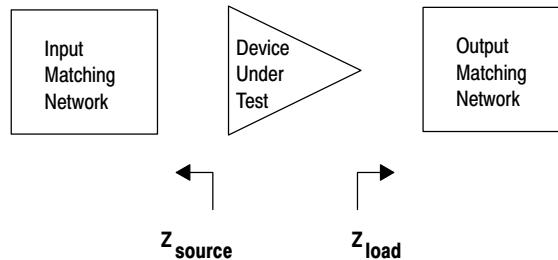
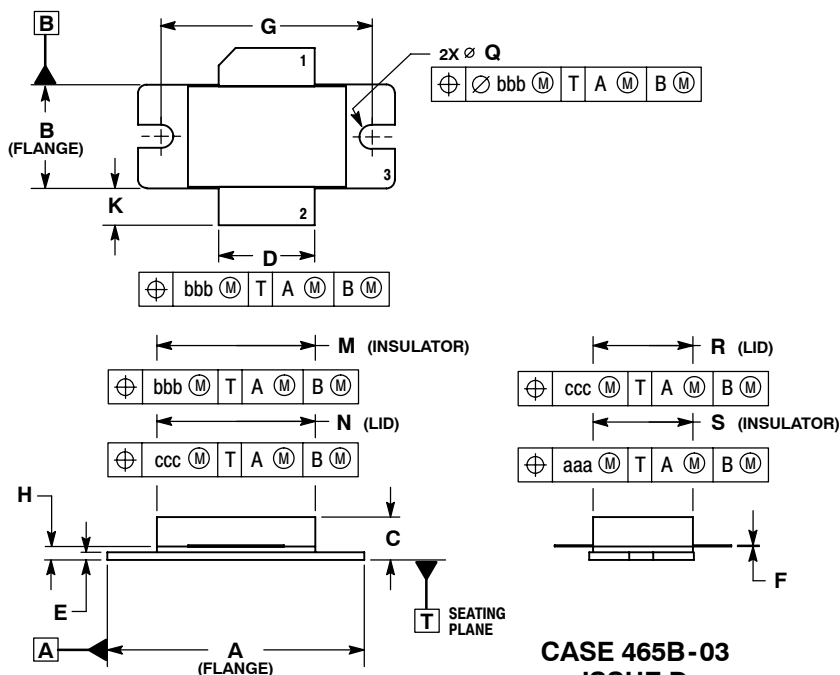

Figure 15. Series Equivalent Source and Load Impedance

PACKAGE DIMENSIONS



CASE 465B-03
ISSUE D
NI-880
MRF6S21190HR3

- NOTES:
1. DIMENSIONING AND TOLERANCING PER ANSI Y14.5M-1994.
 2. CONTROLLING DIMENSION: INCH.
 3. DIMENSION H IS MEASURED 0.030 (0.762) AWAY FROM PACKAGE BODY.
 4. DELETED

DIM	INCHES		MILLIMETERS	
	MIN	MAX	MIN	MAX
A	1.335	1.345	33.91	34.16
B	0.535	0.545	13.6	13.8
C	0.147	0.200	3.73	5.08
D	0.495	0.505	12.57	12.83
E	0.035	0.045	0.89	1.14
F	0.003	0.006	0.08	0.15
G	1.100 BSC		27.94 BSC	
H	0.057	0.067	1.45	1.70
K	0.170	0.210	4.32	5.33
M	0.872	0.888	22.15	22.55
N	0.871	0.889	19.30	22.60
Q	\varnothing .118	\varnothing .138	\varnothing 3.00	\varnothing 3.51
R	0.515	0.525	13.10	13.30
S	0.515	0.525	13.10	13.30
aaa	0.007 REF		0.178 REF	
bbb	0.010 REF		0.254 REF	
ccc	0.015 REF		0.381 REF	

- STYLE 1:
- PIN 1. DRAIN
 - GATE
 - SOURCE

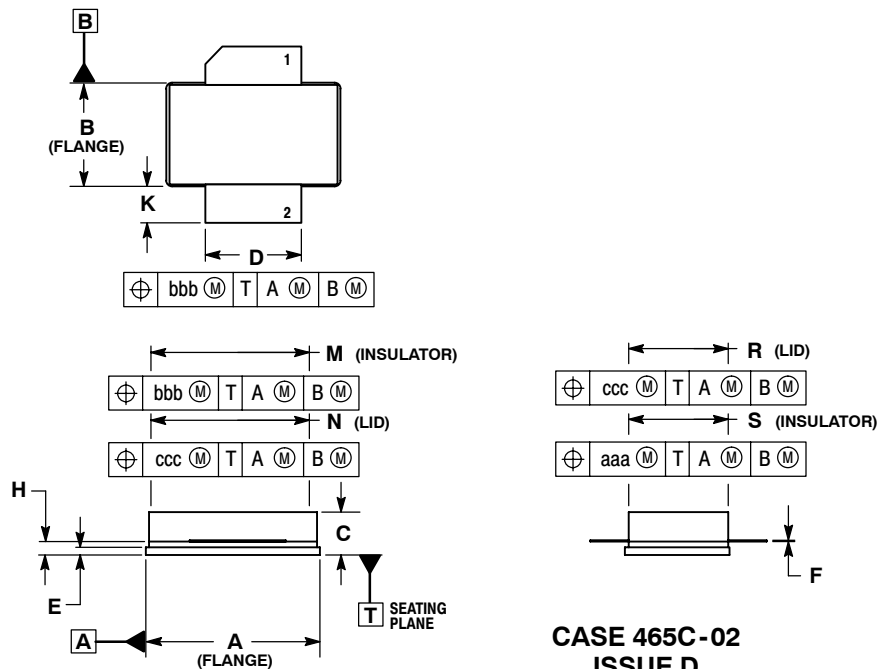

CASE 465C-02
ISSUE D
NI-880S
MRF6S21190HSR3

- NOTES:
1. DIMENSIONING AND TOLERANCING PER ANSI Y14.5M-1994.
 2. CONTROLLING DIMENSION: INCH.
 3. DIMENSION H IS MEASURED 0.030 (0.762) AWAY FROM PACKAGE BODY.

DIM	INCHES		MILLIMETERS	
	MIN	MAX	MIN	MAX
A	0.905	0.915	22.99	23.24
B	0.535	0.545	13.60	13.80
C	0.147	0.200	3.73	5.08
D	0.495	0.505	12.57	12.83
E	0.035	0.045	0.89	1.14
F	0.003	0.006	0.08	0.15
H	0.057	0.067	1.45	1.70
K	0.170	0.210	4.32	5.33
M	0.872	0.888	22.15	22.55
N	0.871	0.889	19.30	22.60
R	0.515	0.525	13.10	13.30
S	0.515	0.525	13.10	13.30
aaa	0.007 REF		0.178 REF	
bbb	0.010 REF		0.254 REF	
ccc	0.015 REF		0.381 REF	

- STYLE 1:
- PIN 1. DRAIN
 - GATE
 - SOURCE

PRODUCT DOCUMENTATION

Refer to the following documents to aid your design process.

Application Notes

- AN1955: Thermal Measurement Methodology of RF Power Amplifiers

Engineering Bulletins

- EB212: Using Data Sheet Impedances for RF LDMOS Devices

REVISION HISTORY

The following table summarizes revisions to this document.

Revision	Date	Description
0	Feb. 2008	<ul style="list-style-type: none">• Initial Release of Data Sheet
1	Mar. 2008	<ul style="list-style-type: none">• Added Fig. 12, MTTF versus Junction Temperature, p. 7

How to Reach Us:

Home Page:

www.freescale.com

Web Support:

<http://www.freescale.com/support>

USA/Europe or Locations Not Listed:

Freescale Semiconductor, Inc.
Technical Information Center, EL516
2100 East Elliot Road
Tempe, Arizona 85284
+1-800-521-6274 or +1-480-768-2130
www.freescale.com/support

Europe, Middle East, and Africa:

Freescale Halbleiter Deutschland GmbH
Technical Information Center
Schatzbogen 7
81829 Muenchen, Germany
+44 1296 380 456 (English)
+46 8 52200080 (English)
+49 89 92103 559 (German)
+33 1 69 35 48 48 (French)
www.freescale.com/support

Japan:

Freescale Semiconductor Japan Ltd.
Headquarters
ARCO Tower 15F
1-8-1, Shimo-Meguro, Meguro-ku,
Tokyo 153-0064
Japan
0120 191014 or +81 3 5437 9125
support.japan@freescale.com

Asia/Pacific:

Freescale Semiconductor Hong Kong Ltd.
Technical Information Center
2 Dai King Street
Tai Po Industrial Estate
Tai Po, N.T., Hong Kong
+800 2666 8080
support.asia@freescale.com

For Literature Requests Only:

Freescale Semiconductor Literature Distribution Center
P.O. Box 5405
Denver, Colorado 80217
1-800-441-2447 or 303-675-2140
Fax: 303-675-2150
LDCForFreescaleSemiconductor@hibbertgroup.com

Information in this document is provided solely to enable system and software implementers to use Freescale Semiconductor products. There are no express or implied copyright licenses granted hereunder to design or fabricate any integrated circuits or integrated circuits based on the information in this document.

Freescale Semiconductor reserves the right to make changes without further notice to any products herein. Freescale Semiconductor makes no warranty, representation or guarantee regarding the suitability of its products for any particular purpose, nor does Freescale Semiconductor assume any liability arising out of the application or use of any product or circuit, and specifically disclaims any and all liability, including without limitation consequential or incidental damages. "Typical" parameters that may be provided in Freescale Semiconductor data sheets and/or specifications can and do vary in different applications and actual performance may vary over time. All operating parameters, including "Typicals", must be validated for each customer application by customer's technical experts. Freescale Semiconductor does not convey any license under its patent rights nor the rights of others. Freescale Semiconductor products are not designed, intended, or authorized for use as components in systems intended for surgical implant into the body, or other applications intended to support or sustain life, or for any other application in which the failure of the Freescale Semiconductor product could create a situation where personal injury or death may occur. Should Buyer purchase or use Freescale Semiconductor products for any such unintended or unauthorized application, Buyer shall indemnify and hold Freescale Semiconductor and its officers, employees, subsidiaries, affiliates, and distributors harmless against all claims, costs, damages, and expenses, and reasonable attorney fees arising out of, directly or indirectly, any claim of personal injury or death associated with such unintended or unauthorized use, even if such claim alleges that Freescale Semiconductor was negligent regarding the design or manufacture of the part.

Freescale™ and the Freescale logo are trademarks of Freescale Semiconductor, Inc. All other product or service names are the property of their respective owners.

© Freescale Semiconductor, Inc. 2008. All rights reserved.

