



Package: QFN, 4mm x 4mm



Product Description

RFMD's SZA-2044 is a high efficiency class AB heterojunction bipolar transistor (HBT) amplifier housed in a low-cost surface-mountable plastic package. This HBT amplifier is made with InGaP on GaAs device technology and fabricated with MOCVD for an ideal combination of low cost and high reliability. This product is specifically designed as a final stage 802.11b/g and 802.16 equipment in the 2.0GHz to 2.7GHz bands. It can run from a 3V to 5V supply. Optimized on-chip impedance matching circuitry provides a 50Ω nominal RF input impedance. The external output match and bias adjustability allows load line optimization for other applications over narrower bands. It features an output power detector, on/off power control, and high RF overdrive robustness. This product is available in a ROHS Compliant and Green package with matte tin finish, designated by the "Z" package suffix.

Optimum Technology Matching® Applied

- GaAs HBT
- GaAs MESFET
- InGaP HBT
- SiGe BiCMOS
- Si BiCMOS
- SiGe HBT
- GaAs pHEMT
- Si CMOS
- Si BJT
- GaN HEMT
- RF MEMS

Functional Block Diagram

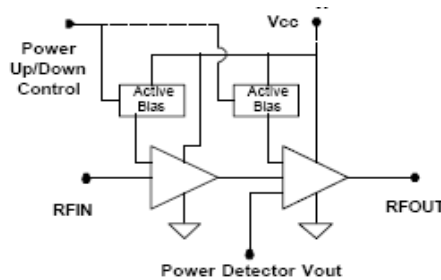

Features

- Z Part Number is Available in RoHS Compliant, Pb-Free, and RFMD Green
- 802.11g 54Mb/s Class AB Performance
- P_{OUT} = 22dBm at 3% EVM, 5V, 340mA
- P_{OUT} = 18dBm at 3% EVM, 3.3V, 175mA
- On-Chip Output Power Detector
- P_{1dB} = 29.5dBm at 5V, P_{1dB} = 25dBm at 3.3V
- Robust - Survives RF Input Power = +15dBm
- Power Up/Down Control <1μs
- Available in RoHS Green Compliant Package

Applications

- 802.11b/g WiFi, 2.4GHz ISM Applications

Simplified Device Schematic

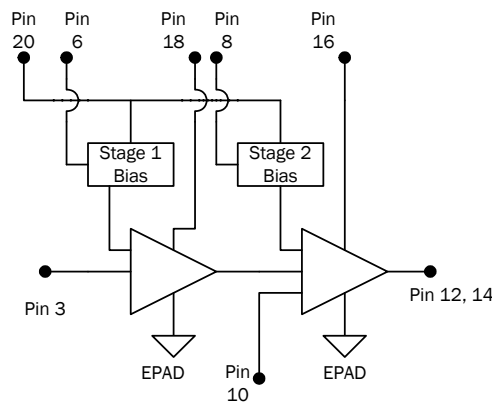

Absolute Maximum Ratings

Parameter	Rating	Unit
VC2 Collector Bias Current (I_{VC2})	500	mA
VC1 Collector Bias Current (I_{VC1})	150	mA
Device Voltage (V_D), No RF drive	7.0	V
Power Dissipation	3	W
Operating Ambient Temperature (T_A)	-40 to +85	°C
Max RF Input Power for 50Ω output load	15	dBm
Max RF Input power for 10:1 VSWR RF out load	8	dBm
Storage Temperature Range	-40 to +150	°C
Operating Junction Temperature (T_J)	+150	°C
ESD Rating - Human Body Model Class 1C (HBM)	500	V
Moisture Sensitivity Level	MSL-1	



Caution! ESD sensitive device.

Exceeding any one or a combination of the Absolute Maximum Rating conditions may cause permanent damage to the device. Extended application of Absolute Maximum Rating conditions to the device may reduce device reliability. Specified typical performance or functional operation of the device under Absolute Maximum Rating conditions is not implied.

The information in this publication is believed to be accurate and reliable. However, no responsibility is assumed by RF Micro Devices, Inc. ("RFMD") for its use, nor for any infringement of patents, or other rights of third parties, resulting from its use. No license is granted by implication or otherwise under any patent or patent rights of RFMD. RFMD reserves the right to change component circuitry, recommended application circuitry and specifications at any time without prior notice.



RFMD Green: RoHS compliant per EU Directive 2002/95/EC, halogen free per IEC 61249-2-21, < 1000ppm each of antimony trioxide in polymeric materials and red phosphorus as a flame retardant, and <2% antimony in solder.

Operation of this device beyond any one of these limits may cause permanent damage. For reliable continuous operation, the device voltage and current must not exceed the maximum operating values specified in the table above. Bias Conditions should also satisfy the following expression:
 $I_D V_D < (T_J - T_L) / R_{TH, j-I}$

Nominal Operating Parameters

Parameter	Specification			Unit	Condition
	Min.	Typ.	Max.		
Frequency of Operation	700		2700	MHz	
Output Power at 1dB Compression		28.5		dBm	1.5GHz
		29.5		dBm	1.8GHz
		29		dBm	2.1GHz
		29.5		dBm	2.4GHz
	28.0	29.5		dBm	2.5GHz
Small Signal Gain		29		dB	1.5GHz
		28.5		dB	1.8GHz
		28		dB	2.1GHz
	23.5	25.5	27.5	dB	2.4GHz
	23.5	25.5	27.5	dB	2.5GHz
Output power		22		dBm	2.4GHz, 3% EVM 802.11g 54Mb/s
		22		dBm	2.5GHz
Noise Figure		6.1		dB	2.5GHz
Third Order Intermod		-46		dBc	1.5GHz, $P_{OUT} = 18$ dBm per tone
		-45.5		dBc	1.8GHz, $P_{OUT} = 18$ dBm per tone
		-43.5		dBc	2.1GHz, $P_{OUT} = 18$ dBm per tone
		-44.0	-40.0	dBc	2.5GHz, 18dBm per tone, 3% EVM with IEEE802.11g 54Mbps
Output IP3		41		dBm	1.5GHz, $V_{CC} = 5$ V
		40.5		dBm	1.8GHz, $V_{CC} = 5$ V
		39.5		dBm	2.1GHz, $V_{CC} = 5$ V
		41		dBm	2.5GHz, $V_{CC} = 5$ V
Worst Case Input Return Loss	10.0	13.0		dB	2.4GHz to 2.5GHz
Worst Case Output Return Loss	9.0	11.0		dB	2.4GHz to 2.5GHz
Output Voltage Range		0.9 to 1.7		V	$P_{OUT} = 15$ dBm to 29dBm
Quiescent Current	255	300	345	mA	$V_{CC} = 5$ V)
Power Up Control Current		1.9		mA	$V_{PC} = 5$ V, ($I_{VPC1} + I_{VPC2}$)
Off V_{CC} Leakage Current		6.0	100.0	uA	$V_{PC} = 0$ V
Thermal Resistance		28		°C/W	junction - lead

Test Conditions: $Z_0 = 50\Omega$, $V_{CC} = 5$ V, $I_Q = 300$ mA, $T_{BP} = 30$ °C

Performance: 2.3GHz to 2.7GHz Evaluation Board Data ($V_{CC} = V_{PC} = 5.0V$, $I_Q = 300mA$)

S11 - Input Return Loss

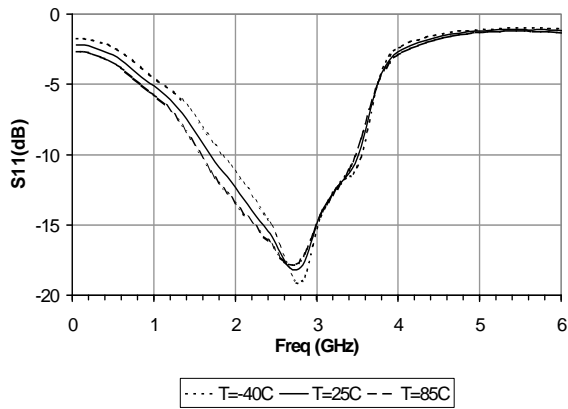

S12 - Isolation

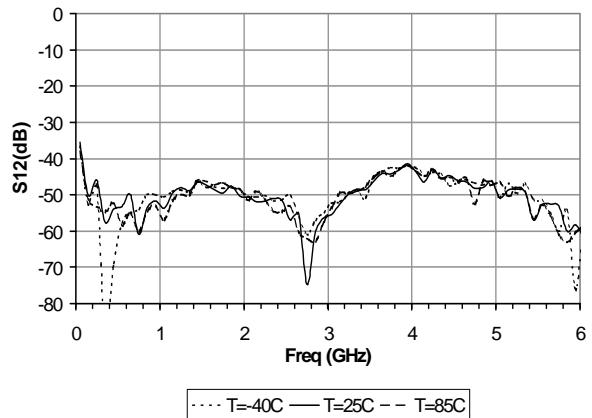

S21 - Gain

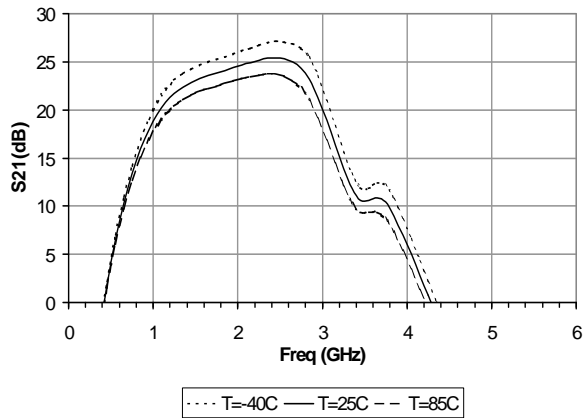

S22 - Output Return Loss

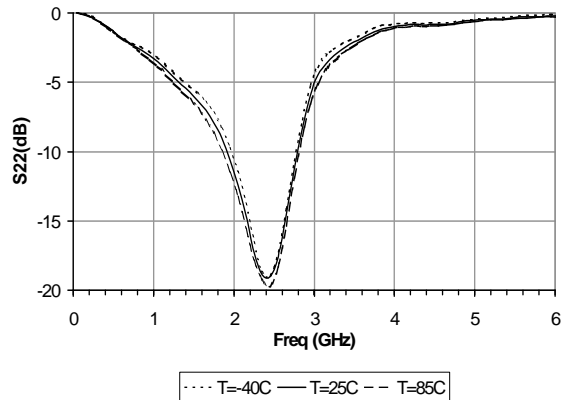

Narrowband S11 - Input Return Loss

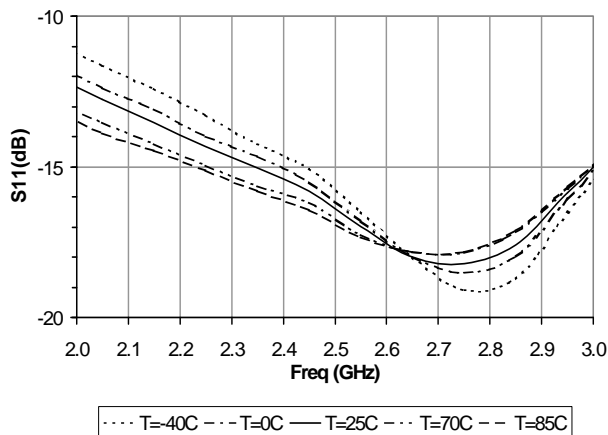

Narrowband S12 - Isolation

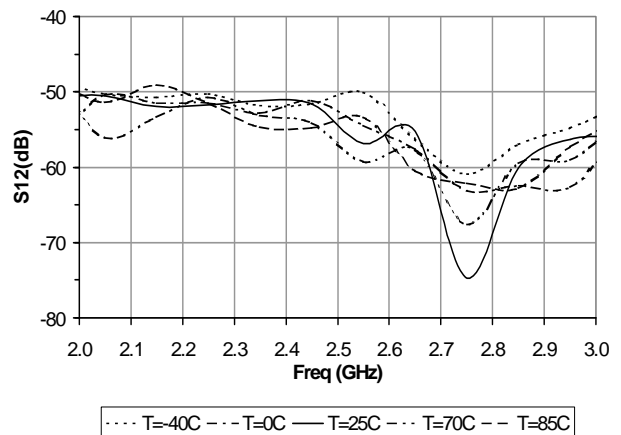

Performance: 2.3GHz to 2.7GHz Evaluation Board Data ($V_{CC} = V_{PC} = 5.0V$, $I_Q = 300mA$)

Narrowband S21 - Gain

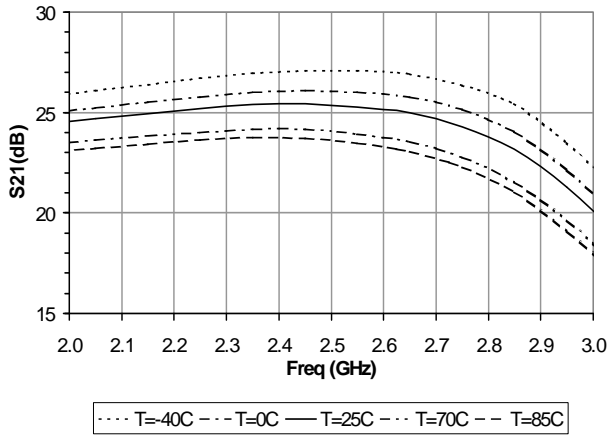

Narrowband S22 - Output Return Loss

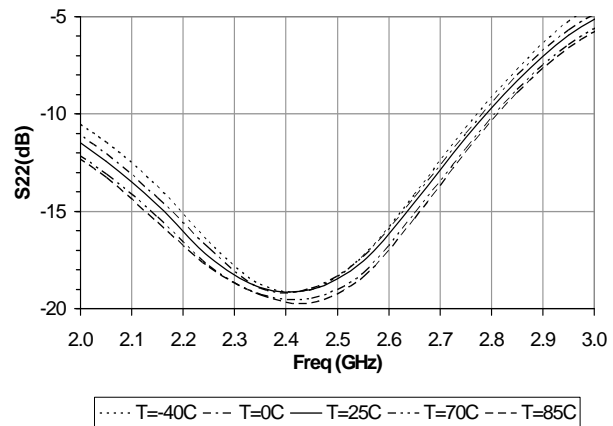

EVM vs Pout, F=2.4GHz
802.11g, OFDM, 54 Mb/s, 64QAM

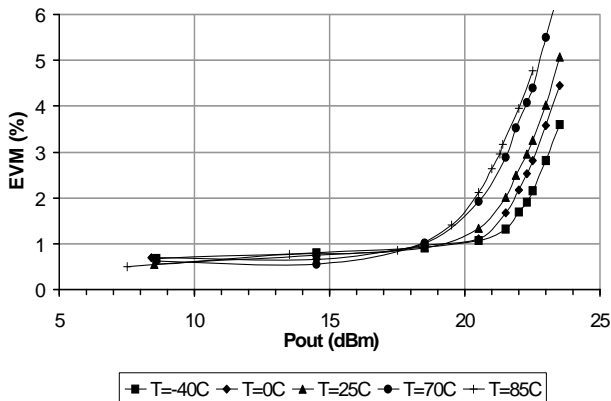

EVM vs Pout, F=2.5GHz
802.11g, OFDM, 54 Mb/s, 64QAM

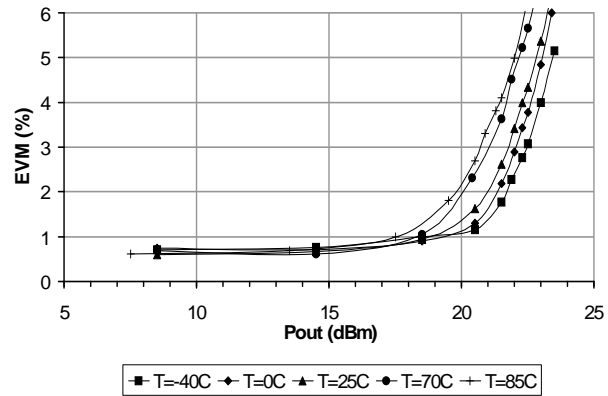

DC Supply Current (Idc) vs Pout, T=25C

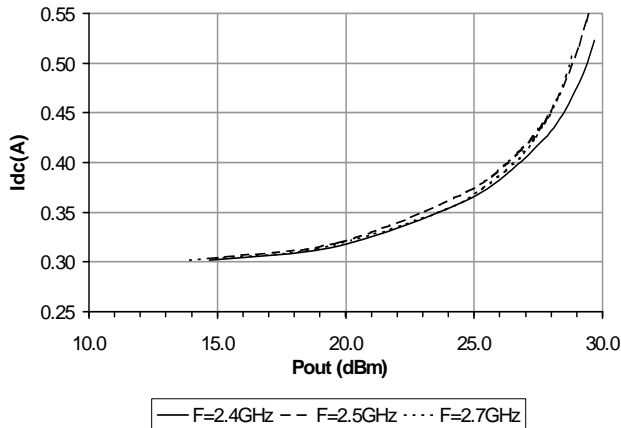

Icq (DC Bias Point) vs Vsupply (V+ and Vpc)

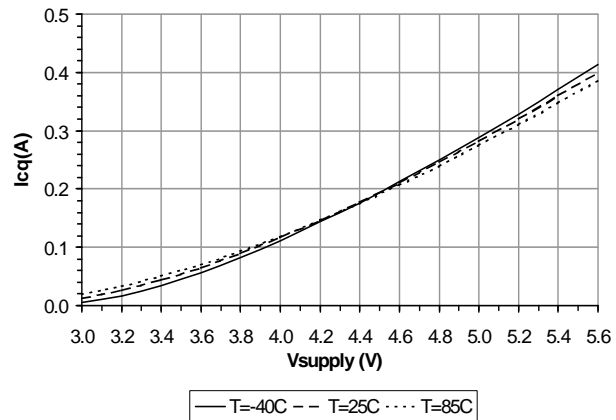

Performance: 2.3GHz to 2.7GHz Evaluation Board Data ($V_{CC} = V_{PC} = 5.0V$, $I_Q = 300mA$)

**RF Power Detector (Vdet) vs Pout
F=2.4GHz**

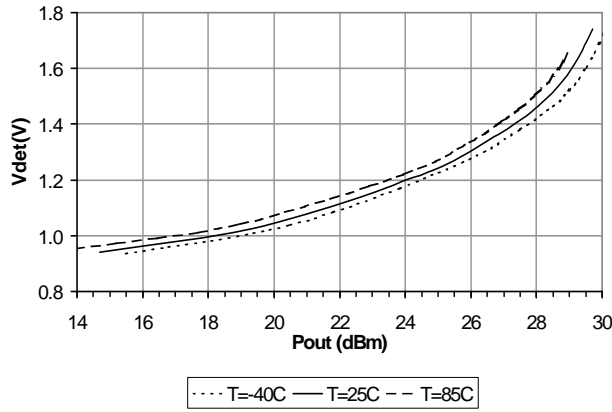

**RF Power Detector (Vdet) vs Pout
F=2.5GHz**

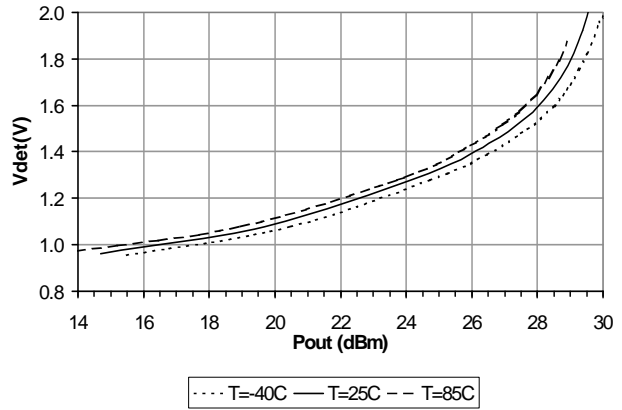

**RF Power Detector (Vdet) vs Pout
F=2.7GHz**

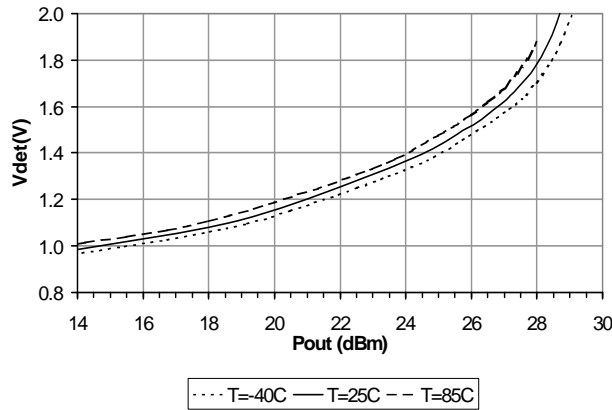

Gain vs Pout, T=25C

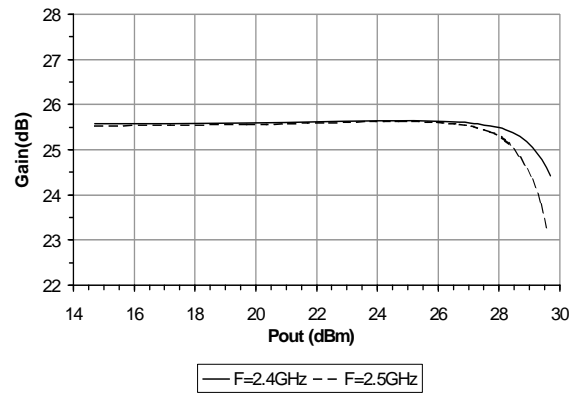

**IM3 vs Pout (2 tone avg.), T=25C
Tone Spacing=1MHz**

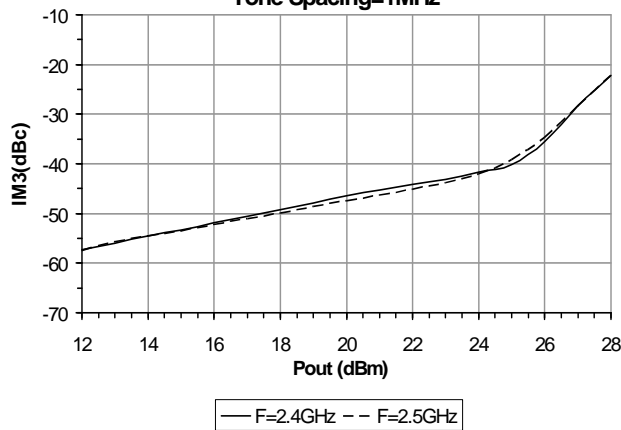

Performance: 2.3GHz to 2.7GHz Evaluation Board Data ($V_{CC} = V_{PC} = 5.0V$, $I_Q = 300mA$)

802.11b Spectral Regrowth vs. Output Power at 2.4 GHz

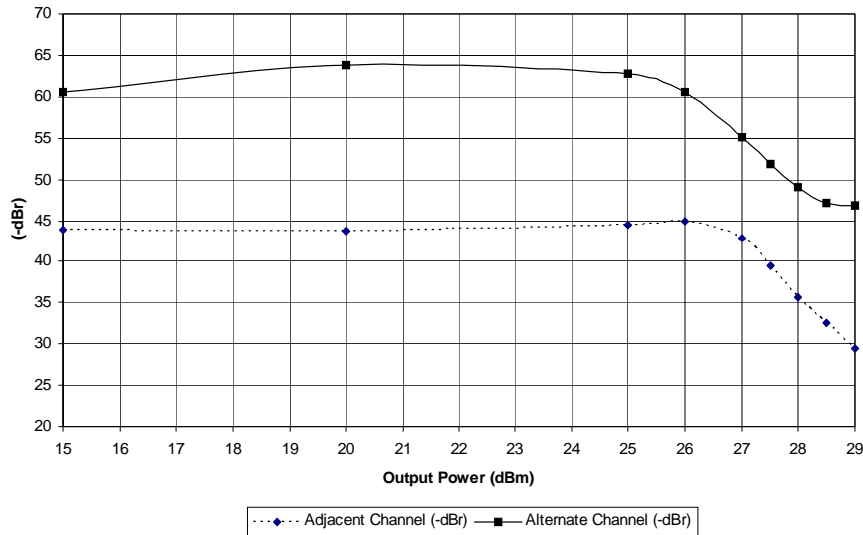

Output Power Spectrum 802.11b 11Mbps cck, Pout = 27.8dBm at 2.4GHz

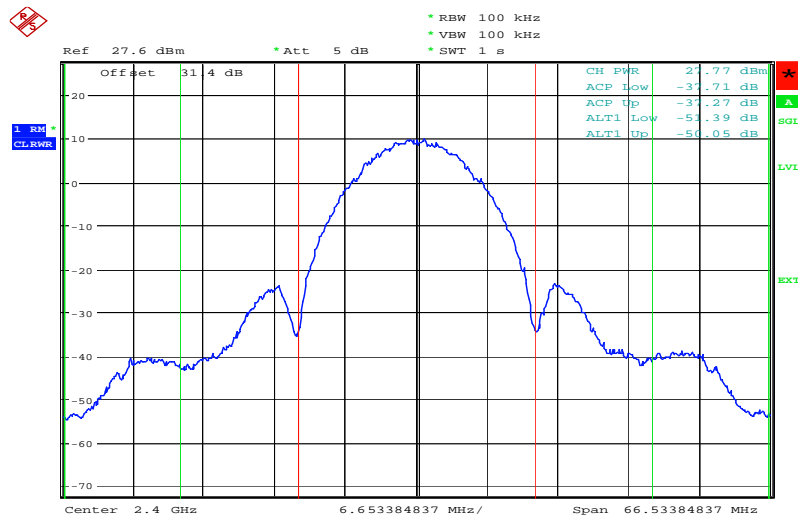

Date: 3.AUG.2004 15:48:28

Pin Names and Descriptions

Pin	Name	Description
1, 2, 4, 5, 7, 9, 11, 13, 15, 17, 19	N/C	These are unused pins and not wired inside the package. They may be grounded or connected to adjacent pins.
6	VPC1	VPC1 is the bias control pin for the stage 1 active bias circuit. An external series resistor is required for proper setting of bias levels. Refer to the evaluation board schematic for resistor value. To prevent potential damage, do not apply voltage to this pin that is +1V greater than voltage applied to pin 20 (Vbias) unless Vpc supply current capability is less than 10mA.
8	VPC2	VPC2 is the bias control pin for the stage 2 active bias circuit. An external series resistor is required for proper setting of bias levels. Refer to the evaluation board schematic for resistor value. To prevent potential damage, do not apply voltage to this pin that is +1V greater than voltage applied to pin 20 (Vbias) unless Vpc supply current capability is less than 10mA.
10	VDET	Output power detector voltage. Load with >10KΩ for best performance
3	RF IN	RF input pin. This is DC grounded internal to the IC. Do not apply voltage to this pin.
12, 14	RF OUT	RF output pin. This is also another connection to the 2nd stage collector.
16	VC2	2nd stage collector bias pin. Apply 3.0V to 5.0V to this pin.
18	VC1	1st stage collector bias pin. Apply 3.0V to 5.0V to this pin.
20	VBIAS	Active bias network VCC. Apply 3.0V to 5.0V to this pin.
EPAD	GND	Exposed area on the bottom side of the package needs to be soldered to the ground plane of the board for optimum thermal and RF performance. Several vias should be located under the EPAD as shown in the recommended land pattern.

Package Drawing

Dimensions in Millimeters (Inches)

Refer to drawing posted at www.rfmd.com for tolerances.

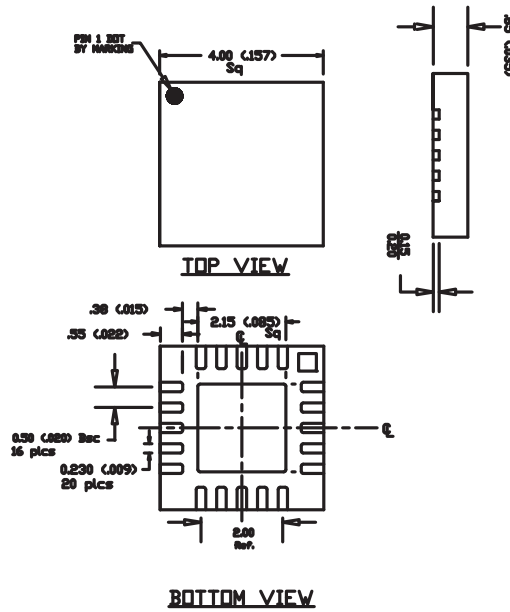

- Notes:
1. Base Metal - Copper Dln 194
 2. Lead Finish
 - Basic FN - Sn/Pb Sn =90%
 - Z option - 100% Matte Sn - .01 (0.0004) thick min

SZA-2044 - 85/15 Sn/Pb plating

SZA-2044Z - Matte Sn plating

Part Symbolization

The part will be symbolized with an "SZA-2044" for Sn/Pb plating or "SZA-2044Z" for RoHS green compliant product. Marking designator will be on the top surface of the package.

1.4GHz to 2.0GHz Application Schematic for $V+ = V_{CC} = 5.0$

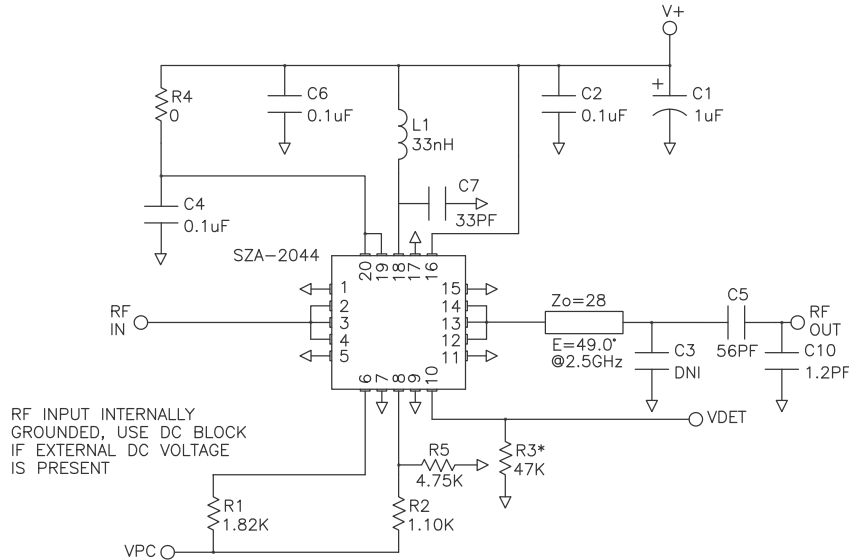

*R3 simulates external circuit loading to ground. Recommended load range is 10KΩ to 100KΩ. May be removed if VDET is not used

2.0GHz to 2.7GHz Evaluation Board Schematic For $V+ = V_{CC} = 5.0$

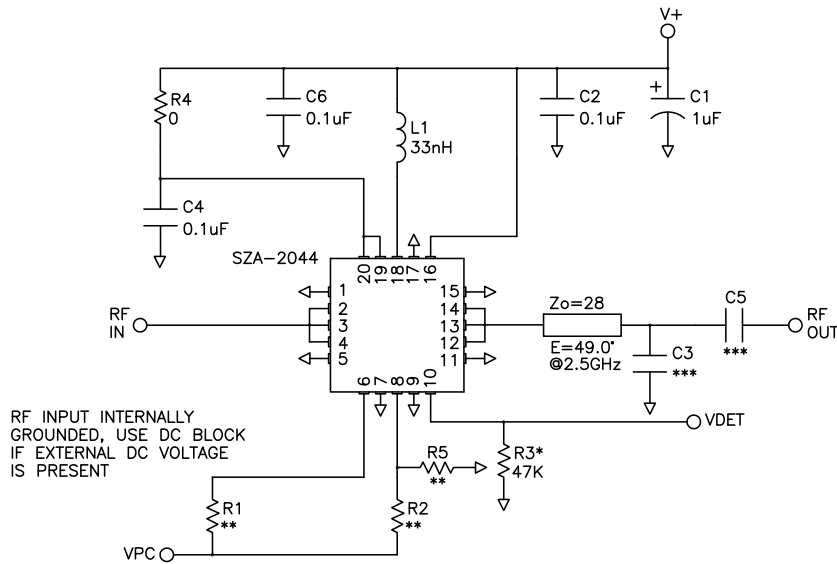

*R3 simulates external circuit loading to ground. Recommended load range is 10kΩ to 100kΩ. May be removed if VDET is not used

**See table below or application note AN-068 for values

***See table below for matching component values

Important Note: Pins 1, 2, 4, 5, 7, 9, 11, 13, 15, 17, 19 are unwired (N/C) inside the package. Refer to page 2 for detailed pin descriptions. Some of these pins are wired to adjacent pins or grounded as shown in the application circuit. This is to maintain consistency with the evaluation board layout shown below. It is recommended to use this layout and wiring to achieve the specified performance.

Evaluation Board Layout and Bill of Materials

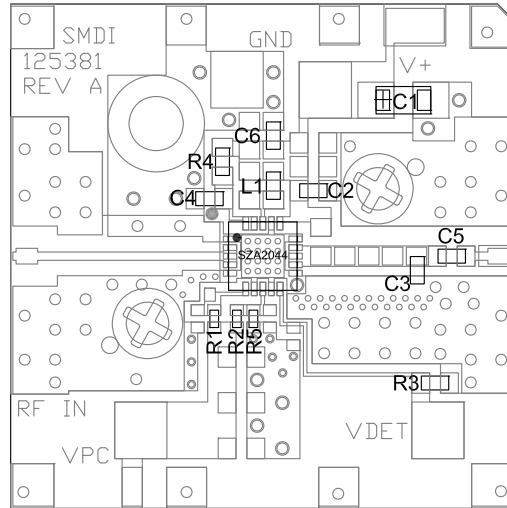

Desg	Description
Q1	SZA-2044
R1	See Table 2, 0402 1%
R2	See Table 2, 0402 1%
R3	47k Ω , 0603 or 0402
R4	0 Ω , 0603 or 0402
R5	See Table 2, 0402 1%
C1	1 μ F 16V Tantalum Cap
C2	0.1 μ F Cap, 0603 or 0402
C3	See Table 1, 0603
C4	0.1 μ F Cap, 0603 or 0402
C5	See Table 1, 0603
C6	0.1 μ F Cap, 0603 or 0402
C7	See Table 1, 0603
C10	See Table 1, 0402
L1	33nH Ind, 0603 (Toko LL1608-FH33NJ or Equiv)

Table 1: Output Matching Capacitor Values

($V_{CC} = 5V, I_Q = 302mA$)

Freq.Range	C3	C5	C7	C10
1.4GHz to 2.0GHz	DNI	56pF	33pF	1.2pF
2.0GHz to 2.2GHz	1.0pF	15pF	DNI	DNI
2.3GHz to 2.7GHz	0.5pF	15pF	DNI	DNI

Table 2: Resistor Values for $V_{PC} = 2.9V$ to $5V$

($V_{CC} = 5V, I_Q = 302mA$)

VPC (V)	R1	R2	R5
2.9	34.8	27.4	Out
3.0	121	105	Out
3.1	205	182	Out
3.2	287	261	Out
3.3	374	332	Out
5.0	1.82k	1.10k	4.75k

Recommended Land Pattern

Dimensions in millimeters (inches)

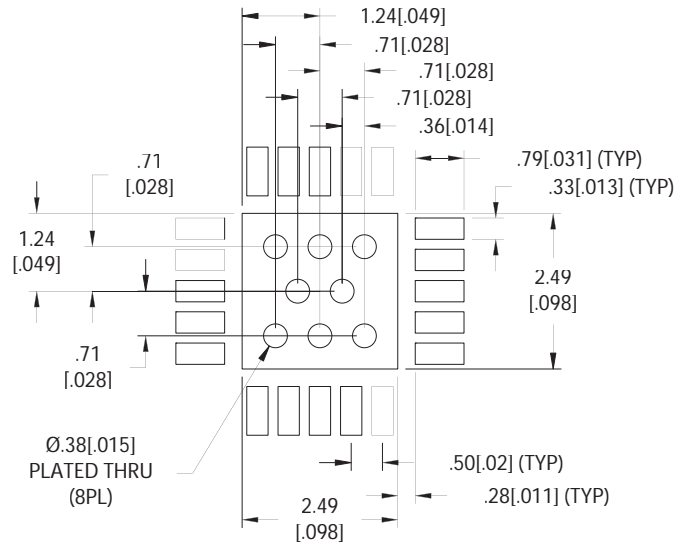

Recommended PCB Soldermask (SMBOC) for Land Pattern

Dimensions in millimeters (inches)

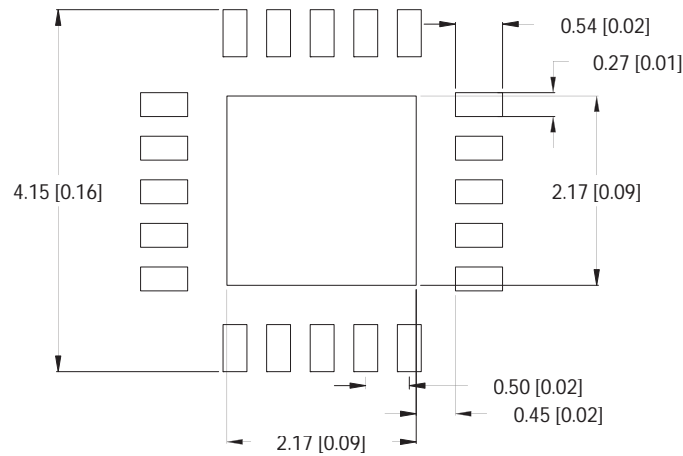

Ordering Information

Ordering Code	Description
SZA2044ZSQ	Standard 25 piece bag
SZA2044ZSR	Standard 100 piece reel
SZA2044Z	Standard 1000 piece reel
SZA2044ZPCK-EVB2	Evaluation Board 2.0GHz to 2.7GHz Tune and 5 loose sample pieces