



Mini Thermal Receipt Printer

Created by Phillip Burgess



Last updated on 2019-03-28 09:50:23 PM UTC

Overview



Add a mini printer to any microcontroller project with this very cute thermal printer. Also known as receipt printers, they're what you see at the ATM or grocery store. Now you can embed a little printer of your own into an enclosure. This printer is ideal for interfacing with a microcontroller, you simply need a 3.3V to 5V TTL serial output from your microcontroller to print text, barcodes, bitmap graphics, even a QR code!

This printer uses very common [2.25" wide thermal paper](http://adafru.it/599), available in the [Adafruit shop](http://adafru.it/599) or any office or stationery supply store. Up to 50 feet of paper can fit in the bay. You will also need a 5 Volt to 9 Volt regulated DC power supply that can provide 1.5 Amps or more during high-current printing — [our 5V 2A power supply will work very nicely](http://adafru.it/276).

[You can pick up a thermal printer pack including printer, paper, power supply and terminal-block adapter in the Adafruit shop!](http://adafru.it/600)

Of course, we wouldn't leave you with a datasheet and a "good luck!" — this tutorial and matching Arduino library demonstrate the following:

- Printing with small, medium and large text
- **Bold**, underline and inverted text
- Variable line spacing
- Left, center and right justification
- Barcodes in the following standard formats: **UPC A**, **UPC E**, **EAN13**, **EAN8**, **CODE39**, **I25**, **CODEBAR**, **CODE93**, **CODE128**, **CODE11** and **MSI** - with adjustable barcode height
- Custom monochrome bitmap graphics
- How to print a QR code

Power

These printers use a thermal head to heat the special receipt paper and draw images and text. That makes the printer very small — there's no moving ink head — but it means they require a lot of power. This printer in particular requires **5 to 9 Volts, 1.5 Amps current!** That means you will need a fairly beefy supply and you **cannot** run it off of USB power. An external adapter is *required!*



We suggest using the [5V 2A power supply in our shop \(http://adafru.it/276\)](http://adafru.it/276). It's got plenty of power to keep the printer happy and you can also use it to run some microcontrollers or sensors off of the remaining 500 mA current that is not required by the printer.

A quick way to power the printer is by just using a [2.1mm jack adapter \(http://adafru.it/368\)](http://adafru.it/368), which you can attach to the printer's red/black wires:

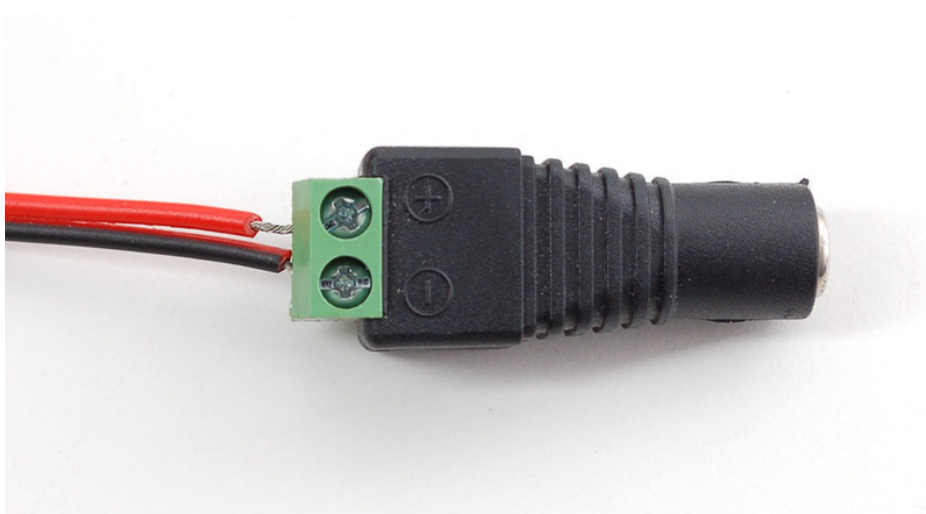

First Test

The first test you should do is to just make sure that the printer is running and you have the power wired up right.

First up, pull the little plastic tab up top to open up the paper holder. Then insert a roll of 57.5mm (2 1/4 inches) thermal paper into the bay as shown below.

- [For Product ID #597 "Mini Thermal Printer"](http://adafru.it/597) (<http://adafru.it/597>) The optimal length of the paper will be 50 feet (about 15 meters) so try to pick up that size. Sometimes if you buy paper from an office supply shop, its a little longer, around 80 or 85 feet in which case you'll need to remove paper from the roll until its 1.5"/40mm in diameter and fits easily.
- [For Product #2751 "Tiny Thermal Printer"](http://adafru.it/2751) (<http://adafru.it/2751>) The optimal length of the paper will be 33 feet (about 10 meters) so try to pick up that size.
- [For Product #2752 "Nano Thermal Printer"](http://adafru.it/2752) (<http://adafru.it/2752>) The optimal length of the paper will be 16 feet (about 5 meters) so try to pick up that size.
- [For our Thermal Printer guts kit](http://adafru.it/2753) (<http://adafru.it/2753>), there's no paper bay so you can use any size.

Make sure that the paper doesn't bind or stick in the bay, it should rotate freely.



As previously described, power the printer using a 5V to 9V 1.5A or higher power supply, such as wiring up a 2.1mm DC power jack:

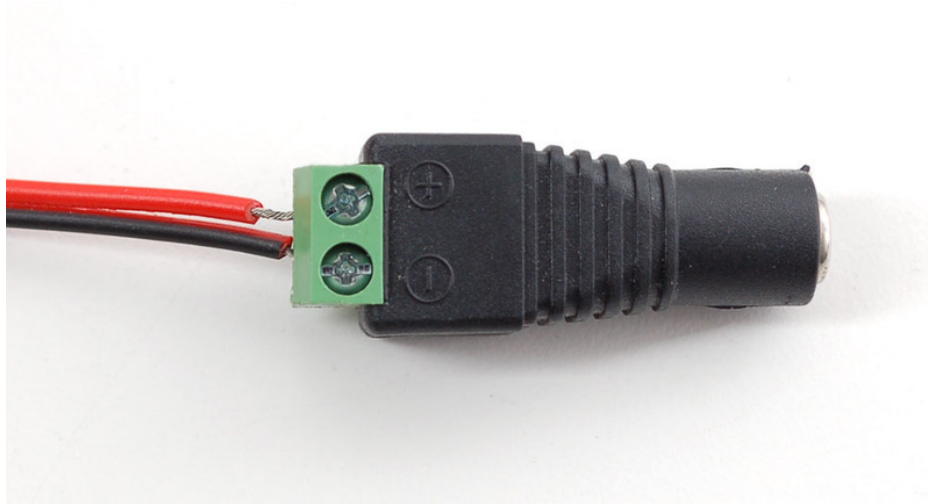

Hold down the button on the top of the printer (or on the control board) while plugging in the power. You should see a receipt print out showing the font table and some diagnostics.

There is no button on the printer guts (#2753). You will need to attach one to J1 or short it manually.

The Green or Red LED could be blinking when the printer is powered. It will not necessarily be on steady!



If you don't get a printout, check that the paper is inserted correctly and not binding, that the power is correctly wired, power supply is plugged in, etc. Then try again, holding down the button when connecting power.

Note the baud rate on the test page. This may be 19200 or 9600. We'll need this number later:

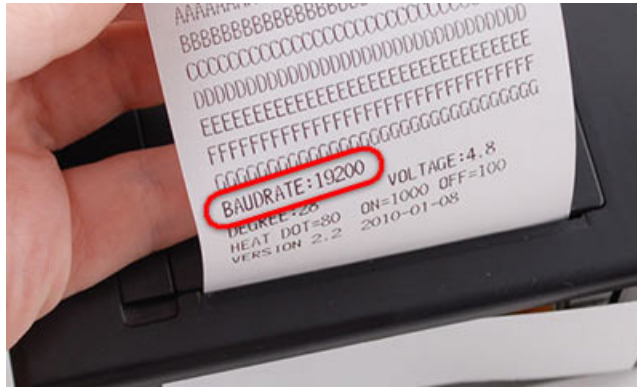

Some printer guts (#2753) do not have a self test.

If no baud rate prints out, try using 9600 as the default.

Arduino Code

To send data to the printer, we will use a 5V TTL serial connection. This is not the same as the 10V RS232 serial from a computer's 9-pin serial port — don't connect the printer directly to a standard PC port or you may damage it. It's possible to use something like an FTDI cable to talk to the printer, but we're going to assume that nearly everyone will want to use it with a microcontroller. This tutorial shows how to wire it up to an Arduino, and our example code is Arduino-compatible. Any microcontroller that can output TTL serial will work, with suitable adaptation to the code.

To start, we'll connect to the data cable of the printer. An easy way to connect is to simply press 22AWG or so wires of matching colors into the plug, then use those to extend the connection to an Arduino.

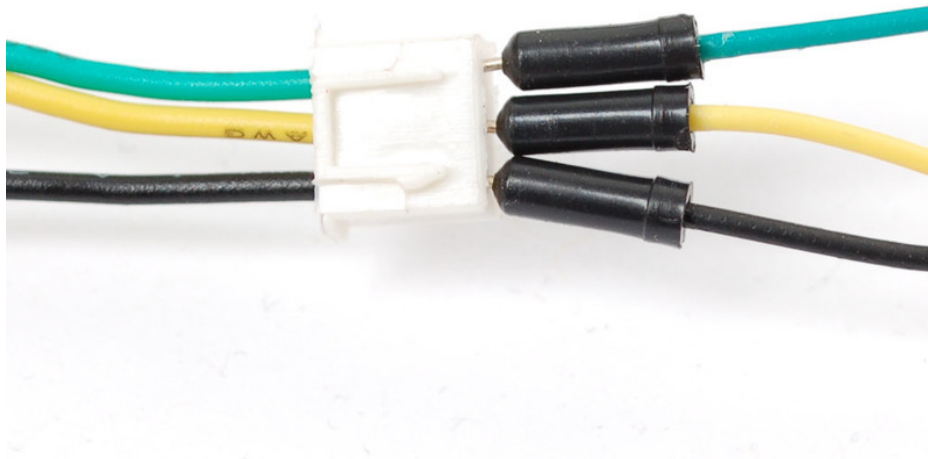

For Product #597

The "Mini Thermal Printer"s data cable has three wires

- black = **GROUND**
- yellow = data **IN** to the printer
- green = data **OUT** of the printer

On the power cable, connect **red** to 5-9VDC power and **black** to power ground

For Product #2751

The "[Tiny Thermal Printer](http://adafru.it/2751)"s (<http://adafru.it/2751>) data cable has **five** wires

- black = **GROUND**
- green = data **IN** to the printer - Opposite of the Mini Thermal printer!
- yellow = data **OUT** of the printer - Opposite of the Mini Thermal printer!

leave red and blue not connected to anything

On the power cable, connect **red** to 5-9VDC power and **black** to power ground

For Product #2752

The "[Nano Thermal Printer](http://adafru.it/2752)"s (<http://adafru.it/2752>) data cable has **five** wires and no power cable

- black = **GROUND**
- blue = data **IN** to the printer (labeled **RX** on the PCB)
- green = data **OUT** of the printer (labeled **TX** on the PCB)
- red = 5-9VDC power (connect the ground of the power plug to the same ground as data above)
- yellow = DTR, not used at this time, skip!

For Product #2753

The "[Thermal Printer Guts](http://adafru.it/2753)"s (<http://adafru.it/2753>) data cable has **five** wires and no power cable

This cable may not have colors in which case look for the text on the connector. Its, sadly, covered when you plug in the cable



- **VH** = 5-9VDC power (connect the ground of the power plug to the same ground as data above)
- **GND** = **GROUND**
- labeled **RX** on the PCB = data **IN** to the printer
- labeled **TX** on the PCB = data **OUT** of the printer
- labeled **DTR** on the PCB = connect to **GND**.

Connect to Arduino

At the Arduino end, the **Data OUT** wire connects to **digital pin 5**, **Data In** goes to **digital pin 6** and **Ground** to any of the **GND** pins. You can change the digital pins later, but to match the example code, stick to this for now!



Note the colors of the wires below don't necessarily match the colors of the data cable, so double check the in and out designation for your product, they're all different!

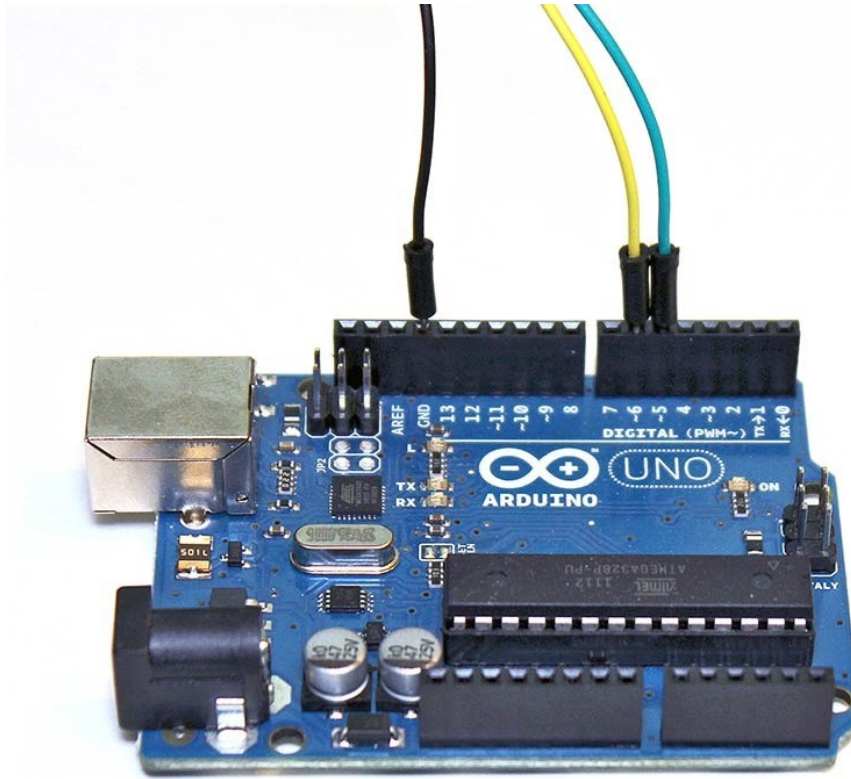

Install Library

Now its time to download the Arduino library code (<https://adafru.it/aHt>).

Go to the Arduino Library manager under **Sketch** -> **Include Library** -> **Manage Libraries...**

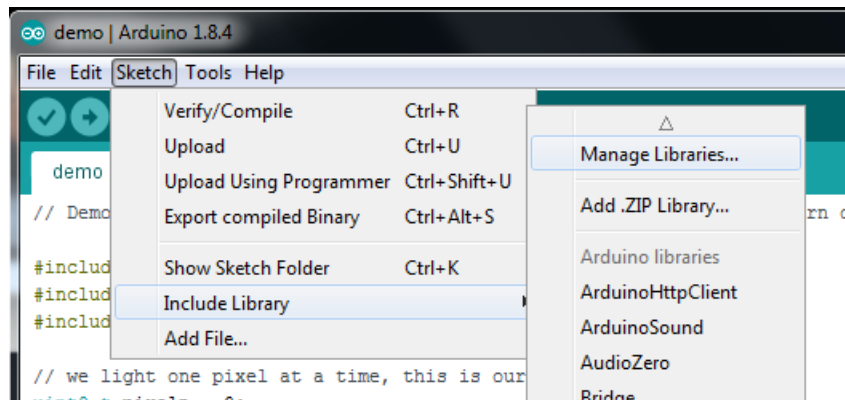

From within the manager install **Adafruit Thermal Printer** library

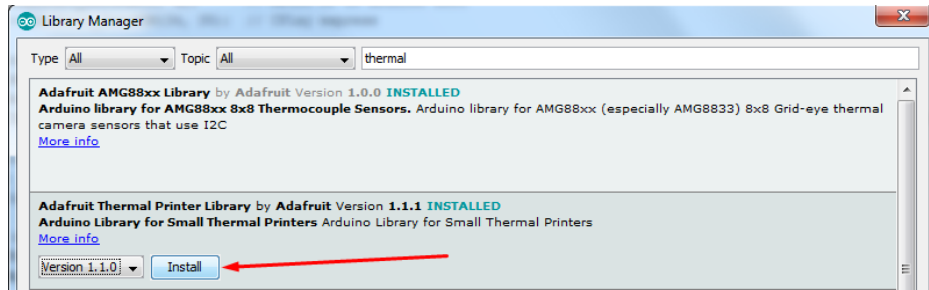

We also have a great tutorial on Arduino library installation at:

<http://learn.adafruit.com/adafruit-all-about-arduino-libraries-install-use> (<https://adafru.it/aYM>)

After installing the library, restart the Arduino IDE.

You should now be able to access the sample code by navigating through menus in this order:

File→Sketchbook→Libraries→Adafruit_Thermal→A_printertest

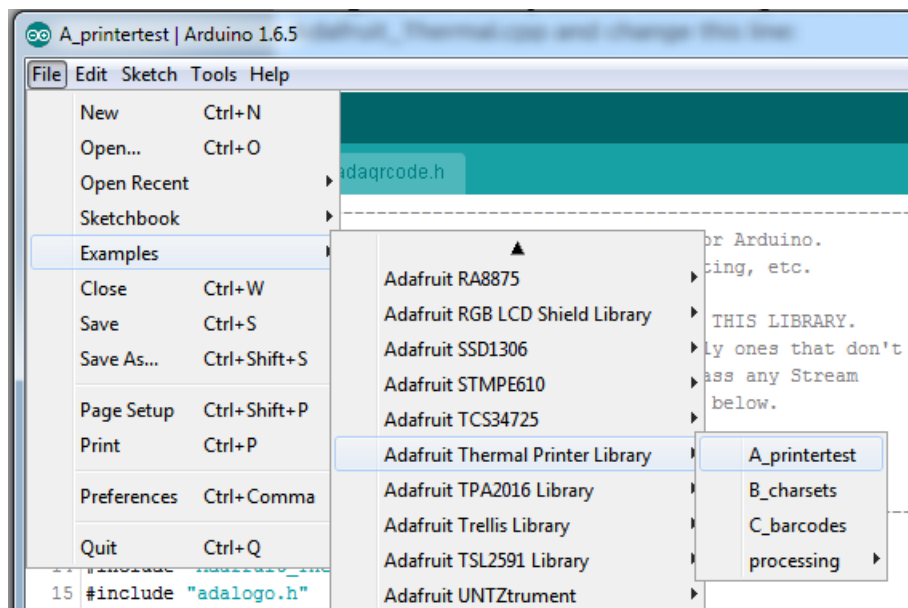

If your printer test page shows 'BAUDRATE: 9600', you'll need to make a small change to the library source code. Using a text editor (Notepad, etc.) open the file Adafruit_Thermal.cpp and change this line:

```
#define BAUDRATE 19200
```

to this:

```
#define BAUDRATE 9600
```

Some printers arrive from the factory set for 19200 baud, but a few may be set to 9600. This will *not* negatively impact the performance of your unit! The speed of the paper through the printer is already much less than this and you will not see any difference...it's strictly a data protocol issue of getting the microcontroller and printer communicating.

OK upload the sketch (with baudrate change if necessary) to the Arduino. You should see the printer print out the example receipt which includes all the capabilities of the library.



If this does not work, first check that the printer and Arduino are both powered, and that the data in, out and ground wires are properly connected to the Arduino.

Printing Text



The thermal printer has a few handy things it can do, most of which are in the `A_printertest` sketch. These are shown in the image above. In order, starting from the top:

- Inverted text: this is invoked by calling `inverseOn()` — you will get text that's white-on-black instead of black-on-white. `inverseOff()` turns this off.
- Double height: this makes text extra tall, call `doubleHeightOn()` — likewise, turn off with `doubleHeightOff()`
- Left/Center/Right justified: this aligns text to the left or right edge of the page, or centered. You can set the alignment by calling `justify('R')` (for right-justified), `justify('C')` (for centered) or `justify('L')` (for left-justified). Left-justified is the default state.
- **Bold** text: makes it stand out a bit more, enable with `boldOn()` and turn off with `boldOff()`
- Underlined text: makes it stand out a bit more, enable with `underlineOn()` and turn off with `underlineOff()`
- Large/Medium/Small text: by default we use small, medium is twice as tall, large is twice as wide/tall. Set the size with `setSize('L')`, `setSize('M')` or `setSize('S')`
- Line spacing: you can change the space *between* lines of text by calling `setLineHeight()` where `numpix` is the number of pixels. The minimum is 24 (no extra space between lines), the default spacing is 32, and double-spaced text would be 64.

Look through the source of the `A_printertest` sketch to see these used in context.

Bitmap Printing

This printer can print out bitmaps, which can add a touch of class to a receipt with your logo or similar.

The first step is to get the logo prepared. The printer can only do monochrome (1-bit) images, and the maximum width is 384 pixels. We suggest starting with a small bitmap (100 pixels or less on each side) and then experimenting to get the size and look you want.

A few steps are required to prepare an image for printing. For Windows users, there's a nice graphical user interface for this. For Mac and Linux, different tools are used...not as visually slick, but they do the job well.



These barcode printers shouldn't be confused with a LaserJet - they're not good at printing heavy/dense images with lots of black or they might stick and stall!

Windows

Use an image editing program to save your image as a 1-bit BMP — in Windows, the built-in **Paint** program will suffice.

Download, install and run **LCD Assistant** (<https://adafru.it/aPs>). This program is for Windows only but does a really fantastic job! Load the BMP file you previously generated (in Paint, etc.). The file must be in BMP format — the software won't read PNG, GIF, etc. Then a couple of settings need to be adjusted...

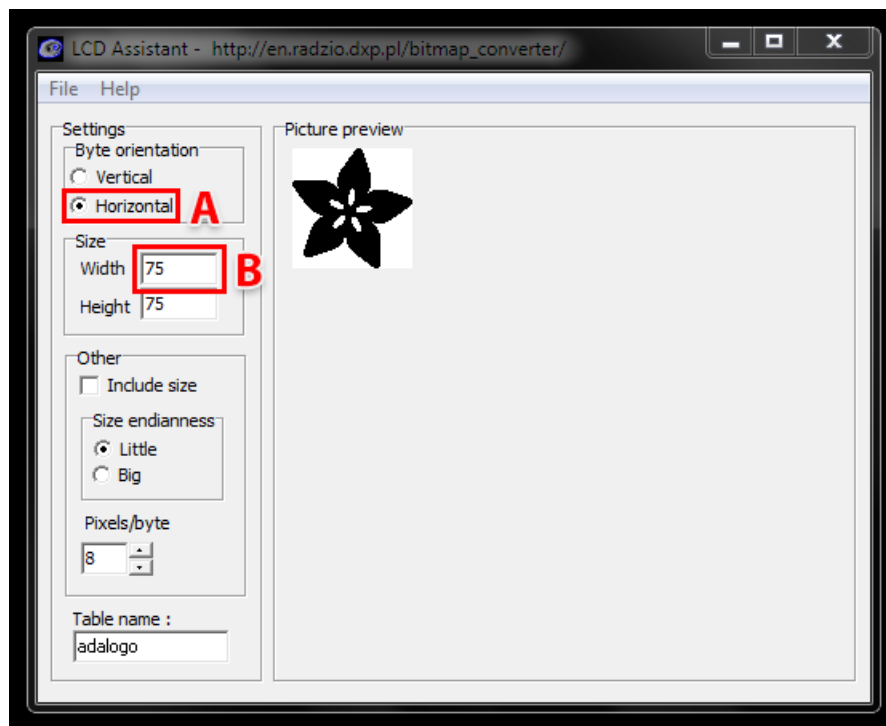

First, in the “Byte orientation” section of the settings, select “Horizontal” (item A in the image above).

Second (item B above), you may need to change the Width setting. Because this software (and the thermal printer) handle images in horizontal groups of eight pixels, if the image width is not a multiple of 8, it will be truncated (cropped) to the nearest smaller 8-pixel boundary. For example, with the 75 pixel wide image above, the output will be

cropped to only 72 pixels wide, losing some data from the right edge. To avoid this, **increase this number to the next multiple of 8** (that would be 80 for the example above), and the output will be padded with blank pixels to cover the gap. Remember the number you use here, you'll need it later.

The image height does not need to be adjusted this way, only width.

Set the table name to something short but descriptive (e.g. "adalogo" above), then select Save Output from the File menu. Give the file a similarly brief but descriptive name, ending in ".h" (e.g. "adalogo.h").

To get this file into your Arduino sketch, select "Add File..." from the Sketch menu. This will add a new tab to your code. Your original code is still there under the leftmost tab.

A couple of small changes are now needed in both tabs. First, at the top of the file containing the new table data, change "const unsigned char" to "static const uint8_t PROGMEM" as shown below:



Next, in the tab containing the main body of your code, add an "include" statement to reference the new file:

```
#include "adalogo.h"
```

Check the **A_printertest** example sketch if you're not sure how to include the code properly.

You can now output the image by calling `printBitmap(width, height, tablename)`, where **width** and **height** are the dimensions of the image in pixels (if you changed the image width to a multiple of 8 as previously described, use that number, not the original image size), and **tablename** is the name of the array in the new tab (e.g. "adalogo" above).



Having a graphical user interface is nice, but some of these extra steps can be confusing and error-prone. If you prefer, the technique below for Mac and Linux works in Windows as well.

Mac and Linux

The conversion tool for Mac and Linux doesn't include a fancy GUI, but it works well and avoids several steps (and potential mis-steps). The source image doesn't need to be in BMP format — most image formats can be read natively — and the output can be added to a sketch with no further editing. It works for Windows as well, if you'd rather use this method.

First, if you don't already have the **Processing** language installed, [download it from processing.org \(https://adafru.it/aPt\)](https://adafru.it/aPt). Processing looks almost exactly like the Arduino IDE, but it's for writing code for your normal computer, not a microcontroller. This can be a little confusing to first-timers, so if something doesn't seem to compile, make sure you're running code in the right environment: *Arduino* for the Arduino board, *Processing* for your computer.



This code runs in Processing 2.x, the latest version of Processing available from their website. Don't use the older Processing 1.5.x version!

The Adafruit_Thermal library folder that you previously downloaded contains a sub-folder called **processing**. Inside that is a sketch called **bitmapImageConvert.pde**. Load this into Processing and press RUN (the triangle button).

You'll be prompted to select an image using the system's standard file selection dialog. The program runs for just a brief instant, and will create a new file alongside the original image file. For example, if you selected an image called "adalogo.png", there will be a new file called "adalogo.h" in the same location. This file contains code to add to your Arduino sketch. You shouldn't need to edit this file unless you want to change the variable names within.

To get this file into your Arduino sketch, select "Add File..." from the Sketch menu. This will add a new tab to your code. Your original code is still there under the leftmost tab.

Next, in the tab containing the main body of your code, add an “include” statement to reference the new file:

```
#include "adalogo.h"
```

Check the **A_printertest** example sketch if you're not sure how to include the code properly.

If the source image was called `adalogo.png`, then the resulting `.h` file (`adalogo.h`) will contain three values called `adalogo_width`, `adalogo_height` and `adalogo_data`, which can be passed directly and in-order to the `printBitmap()` function, like this:

```
printBitmap(adalogo_width, adalogo_height, adalogo_data);
```

Barcode Printing

Thermal printers are really good at printing barcodes! This printer supports 11 different codes - **UPC A, UPC E, EAN13, EAN8, CODE39, I25, CODEBAR, CODE93, CODE128, CODE11** and **MSI**. It only supports linear (1-D) barcodes, and can't generate 2-D barcodes like QR codes (although there is a hack you can do, see below!) Barcodes are generated "on the fly," which is nice — you can customize the height and data included quite easily.

You can make a barcode by calling `printBarcode("barcodedata", BARCODETYPE)`, where the first string is the data to encode (e.g. a UPC code) and **BARCODETYPE** can be **UPC_A, UPC_E, EAN13, EAN8, CODE39, I25, CODEBAR, CODE93, CODE128, CODE11** or **MSI**.

Some barcodes are very restricted — you can only put in 12 numbers, no characters. Others are very flexible and take nearly any character input. [Please check out the wikipedia list detailing kinds of barcodes \(https://adafru.it/aPq\)](https://adafru.it/aPq) to pick the right one for your application.

The available range of barcodes varies with the printer firmware revision. Check `Adafruit_Thermal.h` for a list of codes.

It's also possible to print QR codes, if you're willing to pre-generate them. This might be handy if you want to, let's say, include a URL on the receipt and the URL doesn't change. [You can generate QR codes at many sites including this one. \(https://adafru.it/aPr\)](https://adafru.it/aPr) Use the smallest QR code size. The image will be in PNG format, so if you're using the Windows LCD Assistant tool you'll need to convert it to BMP first (Windows Paint works for this). Then you can convert and embed this in your Arduino sketch as previously described.



CircuitPython

It's easy to use the thermal printer with CircuitPython (or Python) and the [Adafruit CircuitPython Thermal Printer \(https://adafru.it/C5K\)](https://adafru.it/C5K) module. This module allows you to easily write Python code that controls the printer, like printing text and barcodes (note right now bitmap printing is **not** supported by CircuitPython code).

CircuitPython Microcontroller Wiring

First wire up a thermal printer to your board with a serial connection exactly as shown on the previous pages for Arduino. Be sure to supply a power supply to the printer which can provide 5-9V at about 1.5 to 2 amps of current.

Remember too there are two ways to wire the printer, the simplest is just to connect the TX of your board to the RX of the printer--this allows you to print anything but not check the paper status:

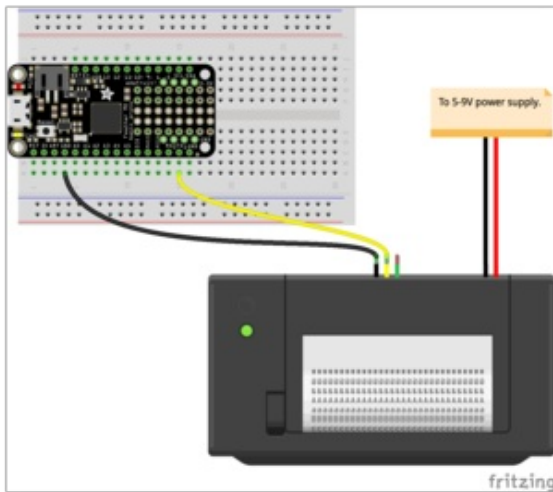

- Printer power positive (red wire) to 5-9V power supply positive.
- Printer power ground (black wire next to red) to power supply negative / ground.
- Printer RX (yellow) to board serial TX.
- Printer ground (black wire next to yellow) to board ground / GND.

A more advanced option is to connect the printer's TX pin to your board's serial RX pin. **However be very careful to ensure your board supports a 5 volt serial input! Many boards, like the Feather M0, do not support a 5V serial input and will be damaged!** You can however create a simple voltage divider with a resistor divider circuit to knock the printer's 5V output down to a safer 3.3V level:

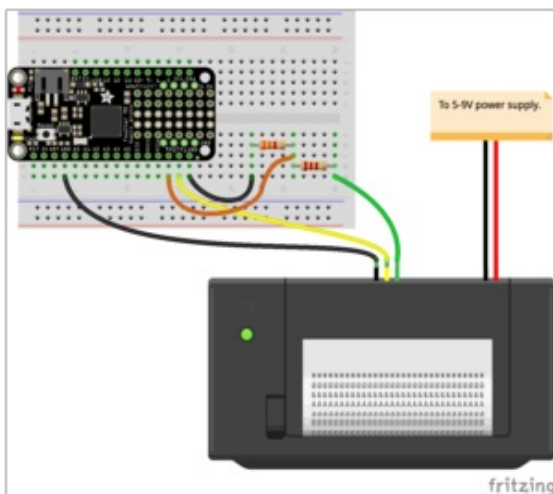

- Printer power positive (red wire) to 5-9V DC power supply positive.
- Printer power ground (black wire next to red) to power supply negative / ground.
- Printer RX (yellow) to board serial TX.
- Printer ground (black wire next to yellow) to board ground / GND.
- Printer TX to one side of a 2.2K Ω resistor.
- One side of a 3.3K Ω resistor to the opposite side of the 2.2K Ω resistor. Other side of the 3.3K Ω resistor to board ground / GND.
- Board RX to the junction of the 3.3K Ω and 2.2K Ω resistor (i.e. output of the voltage divider).

Again be very careful connecting the printer TX (green wire) to your board! As mentioned above you can damage your board if it does not support 5 volt inputs. When in doubt, leave the green wire disconnected! You can still print without the green wire, you only lose the ability to read if paper is present.

Python Computer Wiring

Since there's *dozens* of Linux computers/boards you can use we will show wiring for Raspberry Pi. For other platforms, [please visit the guide for CircuitPython on Linux to see whether your platform is supported \(https://adafru.it/BSN\)](https://adafru.it/BSN).

Here you have two options: An external USB-to-serial converter, or the built-in UART on the Pi's TX/RX pins. Here's an example of wiring up the [USB-to-serial converter \(https://adafru.it/dDd\)](https://adafru.it/dDd):

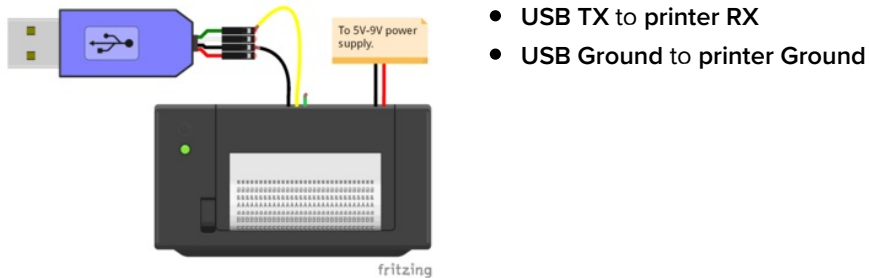

Here's an example using the Pi's built-in UART:

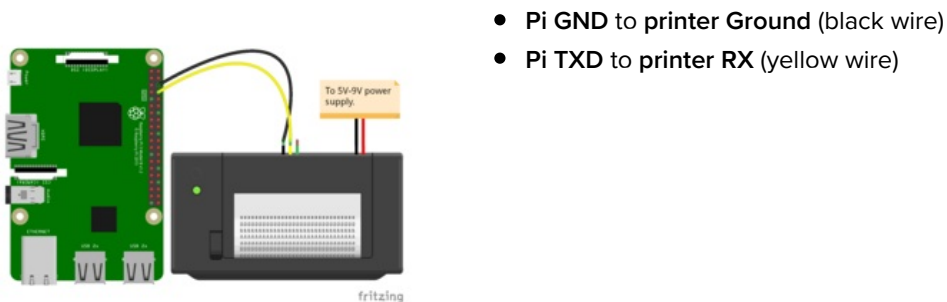

If you want to use the built-in UART, you'll need to disable the serial console and enable the serial port hardware in `raspi-config`. See [the UART/Serial section of the CircuitPython on Raspberry Pi guide \(https://adafru.it/CEk\)](https://adafru.it/CEk) for detailed instructions on how to do this.

If you want to be able to check the printer paper status, you can create a simple voltage divider with a 2.2K Ω and 3.3K Ω resistor circuit to knock the printer's 5V output down to a safer 3.3V level:

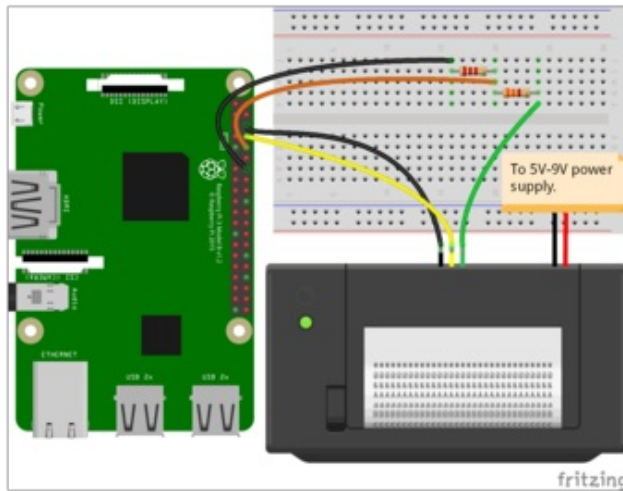

- Printer RX (yellow) to Pi serial TXD.
- Printer ground (black wire next to yellow) to Pi GND.
- Printer TX to one side of a 2.2KΩ resistor.
- One side of a 3.3 KΩ resistor to the opposite side of the 2.2KΩ resistor. Other side of the 3.3KΩ resistor to Pi GND.
- Pi RXD to the junction of the 3.3KΩ and 2.2KΩ resistor (i.e. output of the voltage divider).

You can use the same technique with the USB-to-serial cable:

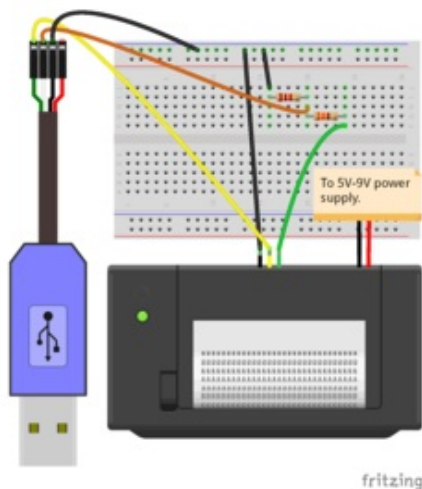

- USB ground to breadboard ground rail.
- Printer RX (yellow) to USB TX (green).
- Printer ground (black wire next to yellow) to ground rail.
- Printer TX to one side of a 2.2KΩ resistor.
- One side of a 3.3 KΩ resistor to the opposite side of the 2.2KΩ resistor. Other side of the 3.3KΩ resistor to ground rail.
- USB RX to the junction of the 3.3KΩ and 2.2KΩ resistor (i.e. output of the voltage divider).

CircuitPython Installation of Thermal Printer Library

If you're using a CircuitPython microcontroller, you'll need to install the [Adafruit CircuitPython Thermal Printer](https://adafru.it/C5K) (<https://adafru.it/C5K>) library on your CircuitPython board.

First make sure you are running the [latest version of Adafruit CircuitPython](https://adafru.it/Amd) (<https://adafru.it/Amd>) for your board.

Next you'll need to install the necessary libraries to use the hardware--carefully follow the steps to find and install these libraries from [Adafruit's CircuitPython library bundle](https://adafru.it/zdx) (<https://adafru.it/zdx>). Our introduction guide has [a great page on how to install the library bundle](https://adafru.it/ABU) (<https://adafru.it/ABU>) for both express and non-express boards.

Remember for non-express boards like the Trinket M0, Gemma M0, and Feather/Metro M0 basic, you'll need to manually install the necessary libraries from the bundle:

- `adafruit_thermal_printer`

You can also download the `adafruit_thermal_printer` folder from [its releases page on Github \(https://adafru.it/C5L\)](https://adafru.it/C5L).

Before continuing make sure your board's lib folder or root filesystem has the `adafruit_thermal_printer` folder copied over.

Python Installation of GPS Library

If you're using a Raspberry Pi or other computer with Python, you'll need to install the `Adafruit_Blinka` library that provides the `CircuitPython` support in Python. This may require verifying you are running Python 3. [Since each platform is a little different, and Linux changes often, please visit the CircuitPython on Linux guide to get your computer ready \(https://adafru.it/BSN\)](https://adafru.it/BSN)!

Once that's done, from your command line run the following command:

```
sudo pip3 install adafruit-circuitpython-thermal-printer
```

Firmware Version and Baud Rate

Before you can use the printer module you must determine the firmware version and baud rate of the printer. This is easy to find out by printing a test page from the printer as described on the [first test page \(https://adafru.it/C5M\)](https://adafru.it/C5M), hold the printer button as power is applied. Print out the test page and take note of these values printed at the bottom:

- **Baudrate** - Remember this value, typically 19200 or 9600.
- **Version** - Take note of this value too, it's a value like 2.2, 2.64, 2.68, etc. You will use the version to pick the appropriate module for interacting with the printer.



Usage

If you're using a CircuitPython microcontroller, [connect to the board's serial REPL \(https://adafru.it/Awz\)](https://adafru.it/Awz) so you are at the CircuitPython >>> prompt. If you're using a computer like the Raspberry Pi, bring up a REPL at the command prompt by typing `python3`. (On some systems, `python` may run Python 3 - just make sure you're not using Python 2, as it isn't supported.)

To demonstrate the usage of the sensor we'll initialize it and print some text from the REPL.

First you must import the necessary modules to initialize the hardware serial connection to the printer. These commands will vary depending on your hardware - choose the appropriate set:

```
# On a CircuitPython microcontroller:
import board
import busio
uart = busio.UART(board.TX, board.RX, baudrate=19200)
```

```
# On the Raspberry Pi with the USB-to-serial converter:
import serial
uart = serial.Serial("/dev/ttyUSB0", baudrate=19200, timeout=3000)
```

```
# On the Raspberry Pi with built-in UART:
import serial
uart = serial.Serial("/dev/serial0", baudrate=19200, timeout=3000)
```

Notice the baud rate of the serial connection is specified with the `baudrate` keyword. For most printers they'll use a rate of 19200 baud, however other printers might be configured to use a different rate like 9600 baud. **Use the baud rate you saw printed on the test page of your printer!**

Also be aware CircuitPython currently requires bi-direction UART connections so even if you don't have the board RX pin hooked up (as recommended) you **must** keep the RX pin disconnected and ignore using it in your project.

Create ThermalPrinter Class

Next you'll need to import the thermal printer module and call a function to get the right class depending on the version of your printer firmware. **Be sure you've found the exact version number for your printer by following the steps mentioned above and on the previous test page!**

```
import adafruit_thermal_printer
ThermalPrinter = adafruit_thermal_printer.get_printer_class(2.69)
```

Notice you call the `get_printer_class` function from within the `adafruit_thermal_printer` module. You must pass this function the version of the thermal printer that you're using and it will internally find the right class to import and use in your code. In this example we're specifying a printer with version 2.69 firmware, but be sure to specify your printer's version!

The result is a class which you can immediately initialize:

Initialize ThermalPrinter

Now construct an instance of the `ThermalPrinter` class:

```
printer = ThermalPrinter(uart)
```

Notice you must pass in the serial UART connection that was previously constructed.

Be aware it will take from a half to even 5 seconds for the printer to be created and initialize itself and warm up. You can optionally specify `auto_warm_up=False` as a keyword and manually call the `warm_up` function to control when this warm-up time occurs if needed in your application (or you are confused why your code takes so long to start up).

Test Page Print

Now you're ready to print!

Try printing a full test page with the `test_page` function:

```
printer.test_page()
```

You should see the printer test page print out.

You can advance the paper forward a number of lines with the `feed` function, try feeding 2 lines to make some space:

```
printer.feed(2)
```

Now print a small line of text with the `print` function and feed a few lines to move it out of the printer to read:

```
printer.print('Hello from CircuitPython!')  
printer.feed(2)
```

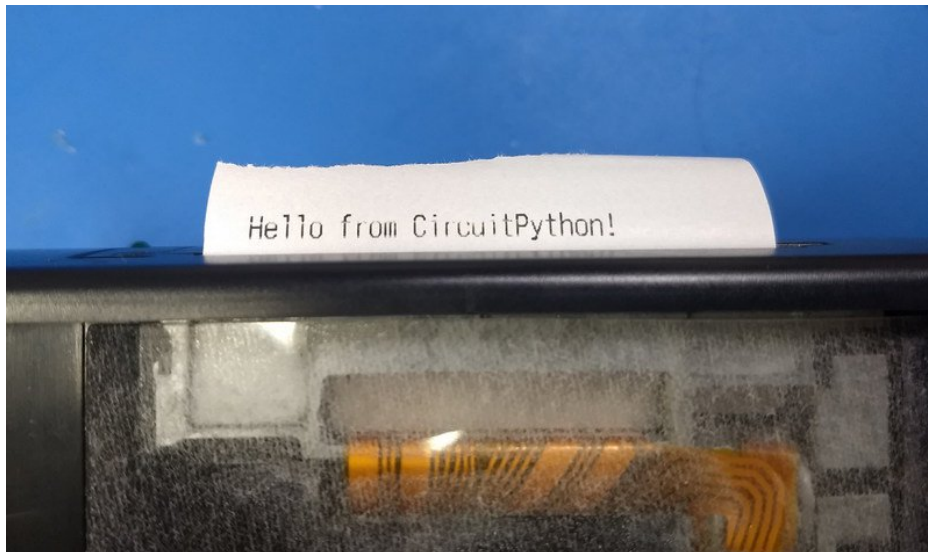

Printer Fonts

There are a few properties you can use to adjust how text is printed. Each of these can be set to a `True` value to enable, or a `False` value to disable:

- `bold` - Print bold text.
- `inverse` - Print inverted (white on black) text.
- `upside_down` - Print upside down text (might not work on all versions of printers).
- `double_height` - Double height size text.
- `double_width` - Double width size text.
- `strike` - Strike-through text (again might not work on all versions of printers).

Try turning on bold text and printing a line:

```
printer.bold = True # Turn on bold
printer.print('This is bold text!')
printer.bold = False # Turn off bold
# Feed lines to make visible:
printer.feed(2)
```

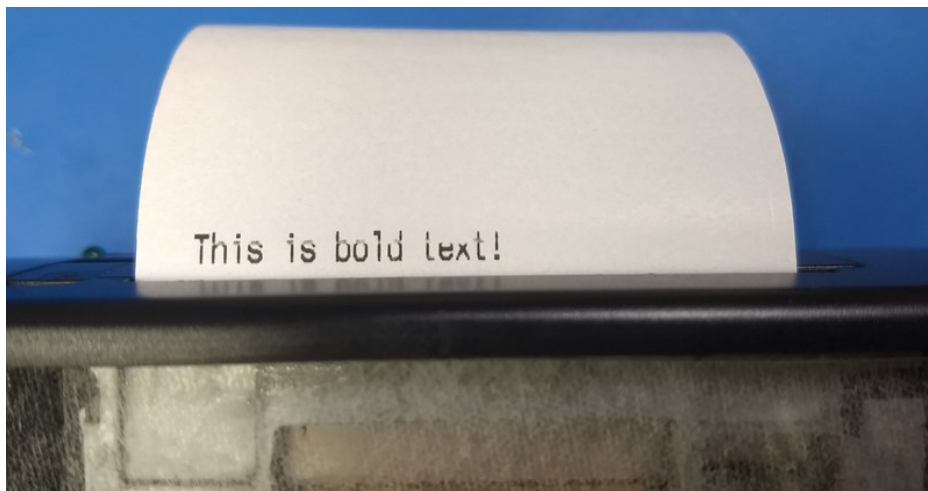

There are a few properties you can set to special values to further control text printing:

- `underline` - This controls underline printing and can be `None` (off), `adafruit_thermal_printer.UNDERLINE_THIN`, or `adafruit_thermal_printer.UNDERLINE_THICK`.
- `size` - This controls the size of text and can be `adafruit_thermal_printer.SIZE_SMALL`, `adafruit_thermal_printer.SIZE_MEDIUM`, or `adafruit_thermal_printer.SIZE_LARGE`. The default is small.
- `justify` - This controls the justification or location of printed text and can be `adafruit_thermal_printer.JUSTIFY_LEFT`, `adafruit_thermal_printer.JUSTIFY_CENTER`, or `adafruit_thermal_printer.JUSTIFY_RIGHT`. The default is justify left.

For example to print thick underlined, medium text, with center justification:

```
printer.underline = adafruit_thermal_printer.UNDERLINE_THICK
printer.size = adafruit_thermal_printer.SIZE_MEDIUM
printer.justify = adafruit_thermal_printer.JUSTIFY_CENTER
printer.print('Medium center!')
# Reset back to normal printing:
printer.underline = None
printer.size = adafruit_thermal_printer.SIZE_SMALL
printer.justify = adafruit_thermal_printer.JUSTIFY_LEFT
# Feed lines to make visible:
printer.feed(2)
```

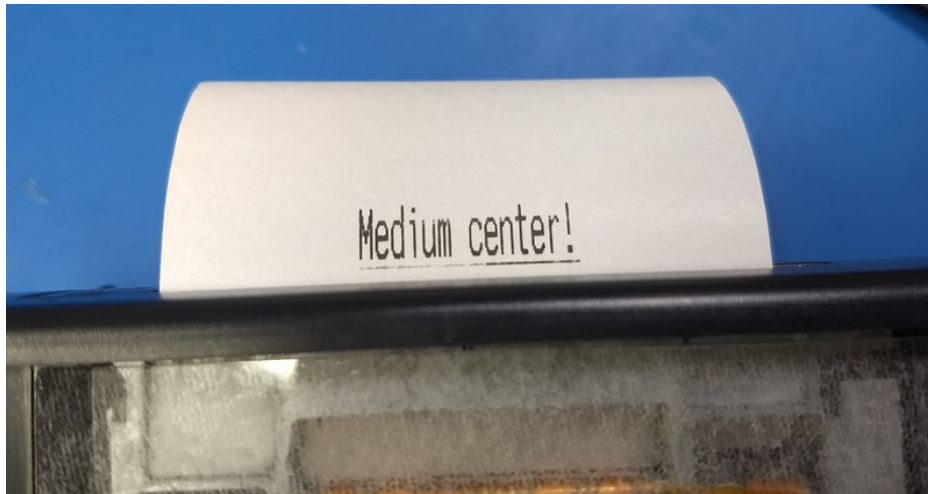

Print Barcodes

Finally you can print a barcode with the `print_barcode` function. Each printer supports a different type and format of barcode so consult the product sheet in the downloads section for each type. However here's an example of printing a UPC A barcode with value '123456789012':

```
printer.print_barcode('123456789012', printer.UPC_A)
printer.feed(2)
```

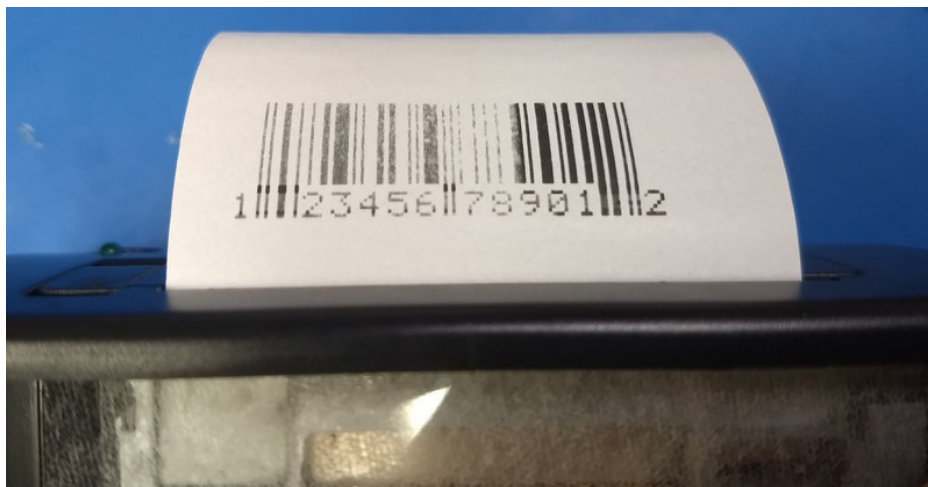

The first parameter to `print_barcode` is a string that defines the barcode value (this varies depending on the type of

barcode, a UPC A code is 13 digits). The second parameter is the type of the barcode, which again is dependent on the printer firmware. Typical values you might use include:

- `printer.UPC_A`
- `printer.UPC_E`
- `printer.EAN13`
- `printer.EAN8`
- `printer.CODE39`
- `printer.ITF`
- `printer.CODABAR`
- `printer.CODE93`
- `printer.CODE128`

Check Paper

If you've connected the RX pin of your board to the printer TX (again be very careful to make sure your board supports a 5V serial RX--many don't!) you can query paper status with the `has_paper` function that returns `True` or `False` if there is paper present:

```
printer.has_paper()
```

```
>>> printer.has_paper()
True
>>>
```

That's all there is to using the thermal printer with CircuitPython!

A complete demo of the usage is in the [thermal_printer_simpletest.py demo in the library \(https://adafru.it/C5N\)](https://adafru.it/C5N).



If you're running `thermal_printer_simpletest.py` on the Raspberry Pi (or any computer), you'll have to make some changes.

On the Raspberry Pi, comment out the `uart = busio(...)` line, and uncomment the `import serial` and `uart = serial.Serial(...)` lines, changing `/dev/ttyUSB0` to the appropriate serial port.

Unless you used a voltage divider to hook up the printer TX line, make sure you comment out the paper check code:

```
# Check if the printer has paper. This only works if the RX line is connected
# on your board (but BE CAREFUL as mentioned above this RX line is 5V!)
#if printer.has_paper():
#    print('Printer has paper!')
#else:
#    print('Printer might be out of paper, or RX is disconnected!')
```

Now you can run the program with the following command:

```
python3 thermal_printer_simpletest.py
```

```

# Simple demo of printer functionality.
# Author: Tony DiCola
import board
import busio

import adafruit_thermal_printer

# Pick which version thermal printer class to use depending on the version of
# your printer. Hold the button on the printer as it's powered on and it will
# print a test page that displays the firmware version, like 2.64, 2.68, etc.
# Use this version in the get_printer_class function below.
ThermalPrinter = adafruit_thermal_printer.get_printer_class(2.69)

# Define RX and TX pins for the board's serial port connected to the printer.
# Only the TX pin needs to be configured, and note to take care NOT to connect
# the RX pin if your board doesn't support 5V inputs. If RX is left unconnected
# the only loss in functionality is checking if the printer has paper--all other
# functions of the printer will work.
RX = board.RX
TX = board.TX

# Create a serial connection for the printer. You must use the same baud rate
# as your printer is configured (print a test page by holding the button
# during power-up and it will show the baud rate). Most printers use 19200.
uart = busio.UART(TX, RX, baudrate=19200)

# For a computer, use the pyserial library for uart access.
# import serial
# uart = serial.Serial("/dev/serial0", baudrate=19200, timeout=3000)

# Create the printer instance.
printer = ThermalPrinter(uart, auto_warm_up=False)

# Initialize the printer. Note this will take a few seconds for the printer
# to warm up and be ready to accept commands (hence calling it explicitly vs.
# automatically in the initializer with the default auto_warm_up=True).
printer.warm_up()

# Check if the printer has paper. This only works if the RX line is connected
# on your board (but BE CAREFUL as mentioned above this RX line is 5V!)
if printer.has_paper():
    print('Printer has paper!')
else:
    print('Printer might be out of paper, or RX is disconnected!')

# Print a test page:
printer.test_page()

# Move the paper forward two lines:
printer.feed(2)

# Print a line of text:
printer.print('Hello world!')

# Print a bold line of text:
printer.bold = True
printer.print('Bold hello world!')
printer.bold = False

```

```

# Print a normal/thin underline line of text:
printer.underline = adafruit_thermal_printer.UNDERLINE_THIN
printer.print('Thin underline!')

# Print a thick underline line of text:
printer.underline = adafruit_thermal_printer.UNDERLINE_THICK
printer.print('Thick underline!')

# Disable underlines.
printer.underline = None

# Print an inverted line.
printer.inverse = True
printer.print('Inverse hello world!')
printer.inverse = False

# Print an upside down line.
printer.upside_down = True
printer.print('Upside down hello!')
printer.upside_down = False

# Print a double height line.
printer.double_height = True
printer.print('Double height!')
printer.double_height = False

# Print a double width line.
printer.double_width = True
printer.print('Double width!')
printer.double_width = False

# Print a strike-through line.
printer.strike = True
printer.print('Strike-through hello!')
printer.strike = False

# Print medium size text.
printer.size = adafruit_thermal_printer.SIZE_MEDIUM
printer.print('Medium size text!')

# Print large size text.
printer.size = adafruit_thermal_printer.SIZE_LARGE
printer.print('Large size text!')

# Back to normal / small size text.
printer.size = adafruit_thermal_printer.SIZE_SMALL

# Print center justified text.
printer.justify = adafruit_thermal_printer.JUSTIFY_CENTER
printer.print('Center justified!')

# Print right justified text.
printer.justify = adafruit_thermal_printer.JUSTIFY_RIGHT
printer.print('Right justified!')

# Back to left justified / normal text.
printer.justify = adafruit_thermal_printer.JUSTIFY_LEFT

# Print a UPC barcode.

```

```
printer.print('UPCA barcode:')
printer.print_barcode('123456789012', printer.UPC_A)

# Feed a few lines to see everything.
printer.feed(2)
```

Python Docs

[Python Docs \(https://adafru.it/C50\)](https://adafru.it/C50)

Downloads

- [Adafruit_Thermal library for Arduino \(https://adafru.it/aHt\)](https://adafru.it/aHt).
- [LCD Assistant \(https://adafru.it/aPs\)](https://adafru.it/aPs) — optional bitmap conversion utility for Windows.
- [Processing \(https://adafru.it/aMI\)](https://adafru.it/aMI) language — needed for bitmap conversion for Mac or Linux (and optionally Windows). DOWNLOAD VERSION 1.5.1, not the 2.0 beta.
- [Thermal Printer User Manual \(https://adafru.it/C5P\)](https://adafru.it/C5P).
- [An older version of the Thermal Printer User Manual \(https://adafru.it/C5Q\)](https://adafru.it/C5Q).
- [Thermal Printer Product Sheet \(https://adafru.it/C5R\)](https://adafru.it/C5R).

Firmware Changer

If you'd like to risk it, you can revert/change the firmware using this tool that is from the manufacturer. We haven't tried it. It's completely utterly unsupported and you may break your printer. We won't replace it if it stops working due to a firmware change!

<https://adafru.it/oAA>

<https://adafru.it/oAA>

Troubleshooting!

📄 I'm not getting it to work!



□ I'm trying the self test and it's still not working.

□

📄 I'm having difficulty getting a printout



My Arduino sketch used to work, but doesn't compile now!



□ My sketch compiles, but the output is different than before.



□ The USB printer is not showing up as expected.
□



UNTIL YOU GET:

```
Current USB:Printable Port
Press FEED 2s to Shift USB Func
Press FEED less 2s to exit
```

HOLD AGAIN FOR 2 SECS

```
Current USB:COM
*****Exit*****
```

DONE!

Hacking!



Look at those huge, razor-sharp image prints! You want some?

The following...

- Is an **undocumented** printer feature and is **NOT guaranteed** to work.
- May require **modifying** your printer — a **warranty-voiding** operation! Continue at your own risk.

You should *only* attempt this if *all* of the following apply:

- Have first confirmed that the **printer works as expected** when operated through **conventional procedures**.
- Have a **genuine performance bottleneck** that cannot be adequately resolved by **adjusting the printer timing** and thermal settings first.
- Are comfortable **opening things** and **soldering**.

A modified printer is not eligible for a refund or exchange.

These printers have a limited serial receive buffer. Push bits to the printer faster than it can physically heat dots and feed paper, and you experience an “overflow” — bitmap images become garbled, text and formatting commands may be skipped.

The thermal printer library tries to throttle data to the printer at just the right rate. Too fast and an overflow occurs. Too slow and it wastes your time; the printer isn’t operating at peak throughput. This is an imperfect process...though we use very conservative timing estimates, the actual speed through the printer is impossible to predict...sometimes overflows *still* occur.

Hardware handshaking is a means by which a printer or other device can report to the microcontroller that it’s ready to receive more data, virtually eliminating buffer overflows while operating at peak throughput...the paper feed stops only when it physically absolutely must. Optimal performance.

It appears that some varieties of these thermal printers support hardware handshaking (e.g. firmware v2.64, 2.68). This

is barely mentioned in the datasheet, and in fact **there isn't even a physical connection for this on the outside of the printer**. A little surgery is in order...



The “Tiny” and “Nano” printers (plus the “Printer Guts”) have an exposed DTR pin — no modification is necessary! Scroll down to the “Code Changes” section to continue.

Parts and Tools Needed

- Small Phillips head screwdriver
- Pliers
- Soldering iron and related paraphernalia
- A bit of wire...but ideally a female jumper wire

Procedure



Unplug all cables, turn the printer over and remove the two small Phillips screws.

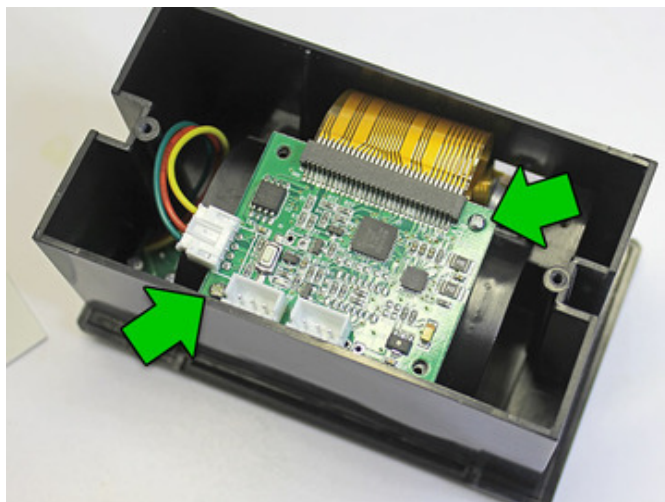

Take the back plate off, then remove the two (or sometimes four) Phillips screws holding the circuit board in place.

These screws are a little smaller than the back-holding ones...don't get them mixed up!

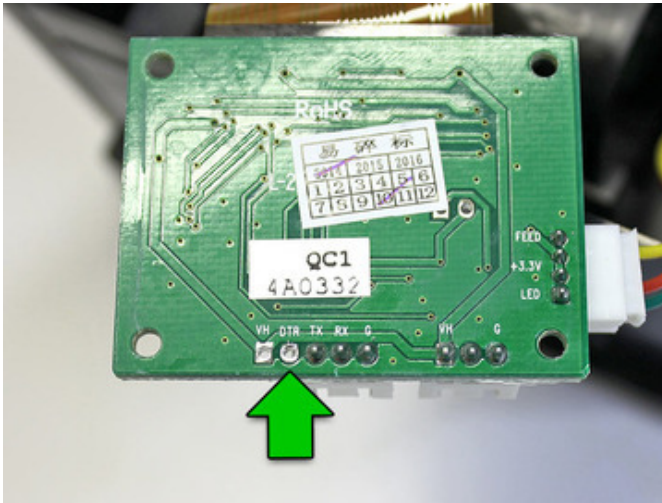

Carefully, so as not to unseat or unplug the connectors, turn the circuit board over and look for the unpopulated via labeled “DTR.”

There are some other interesting solder points in here, if you’re so inclined. “HV” is the raw 5–9 Volts from the power supply. On the right is a 3.3V pin, though I don’t know the available current. Conceivably one could bring these out to reduce overall cabling in a project...or even install a tiny microcontroller right inside!



Cut an end off a female jumper wire and strip & tin the end.

This will be hanging out of the printer...so a *female* jumper prevents accidental contact with things if you’re not using the connection. If you only have regular wire, that’s fine, just be careful not to leave a bare end dangling.

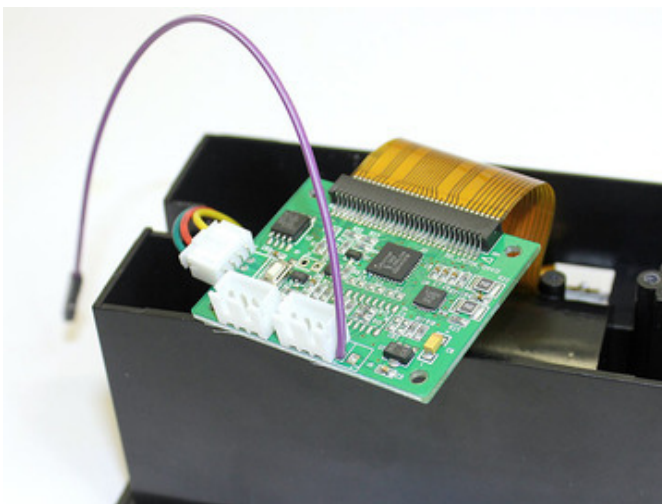

Solder the wire to the DTR pad. Top, bottom, doesn’t matter...it’s right up against the serial connection plug, so use whatever path works best for you, there’s ample room for routing the wire around either way.

Pedants may note that this isn’t technically a DTR pin, but rather CTS. It’s long-standing thing among printer manufacturers...apparently the misnomer was made decades ago but has stuck for consistency.

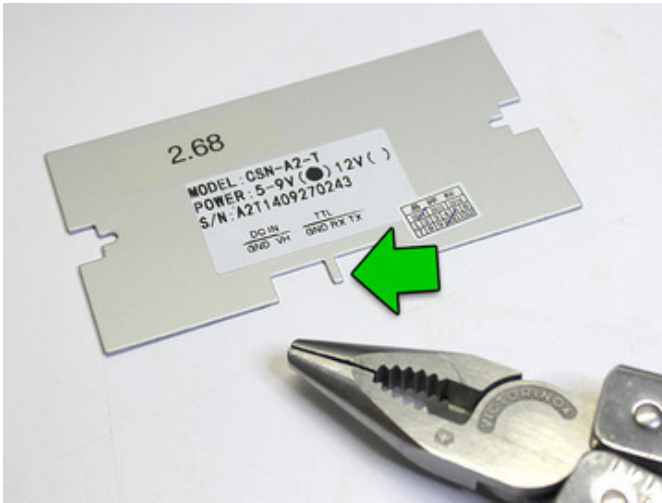

On the back plate, there's a small metal "finger" between the serial and power sockets. Using pliers, this can be bent back to provide an exit route for the DTR wire.



Screw the controller board back in place (check that neither of the cables has come unseated), routing the DTR wire around between the two sockets, then screw the back on.

Finished with the hardware!

You can then reconnect the power and serial sockets, and wire those up as before.

Use a jumper wire to connect DTR to any available Arduino pin. In our examples, we'll use digital pin 4.

The printer electronics operate at 3.3V, so no level shifting is needed with 3.3V boards (Arduino Due, etc.)...this can safely be connected directly.

Code Changes

Just one line...the `Adafruit_Thermal` constructor...needs changing. It can accept an optional parameter, a pin number to use for DTR:

```
Adafruit_Thermal printer(&mySerial, 4);
```

This works just as well with a hardware serial port (e.g. Arduino Mega or Due):

```
Adafruit_Thermal printer(&Serial1, 4);
```

No other changes are necessary. Try this with one of the example sketches...you'll find the printer is suddenly *lots* faster! That's because the software throttle is no longer used...the printer continually reports its actual "ready" state to the microcontroller.

Printing Huge Images

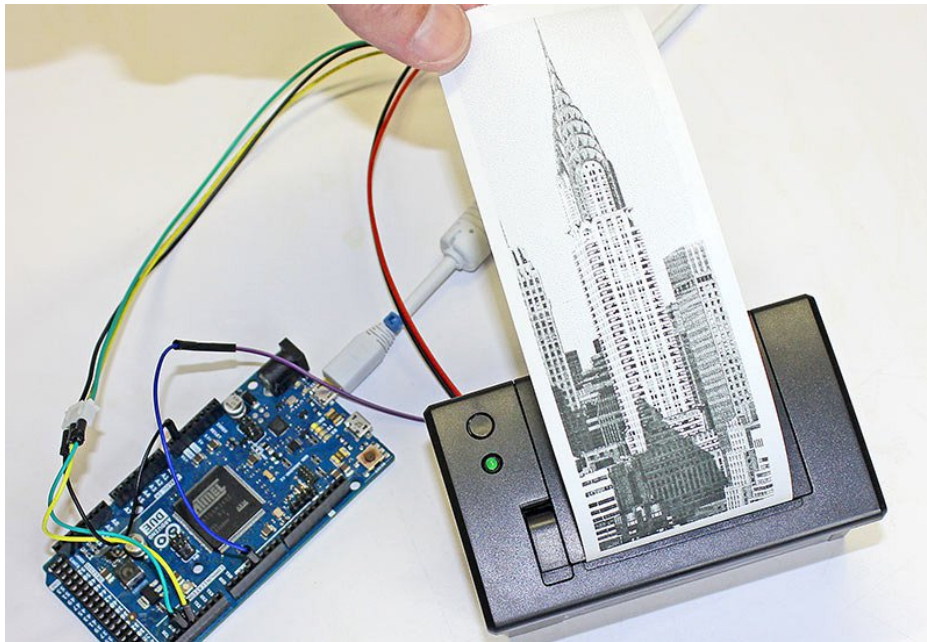

The `printBitmap()` function can output images from an open stream or stored in `PROGMEM` (flash memory)...as explained on the "Printing Bitmaps" page.

Although the Arduino Mega has a whopping 256K flash space, a limitation of the AVR microcontroller is that a single array can't exceed 32K...that's about a 384x680 pixel bitmap image. If you try to embed a larger image in your code, the compiler will report an error.

One workaround might be to break really long images into multiple smaller images, and print these out consecutively without a `feed()` in between.

Another is to use a non-AVR Arduino-compatible board, such as the 32-bit Arduino Due. This has no problem with massive arrays. The Chrysler Building image above is 384x1132 pixels!

Other Things to Know

This type of printer fares best with light line art and sometimes dithered photographic images as long as the overall dot density is fairly low, like under 50%. Large solid-filled areas exhibit strange streaky artifacts...this isn't a bug of the library or printer firmware, but just a side-effect of how receipt printers operate, that they can only heat so many dots at a time and have to pull shenanigans to go beyond that, else they jam.



Here are a couple examples from fancy commercial receipt printers.

Notice in the first one that the “solid black” area isn't *really* solid black...examining it closely, you can see it's densely dithered, but not 100% filled.

The second *does* have solid fills, but limits the total area. On any given row, only so many pixels are set.

Lucky

If you try to print a “dense” image and the paper jams (image gets squashed vertically), pass a lower density value to `printer.begin()`. Default value is 120. So for example:

```
printer.begin(80);
```

DTR support is not a panacea. **Glitches occasionally do still happen**...sometimes overflows, sometimes “framing errors” with serial data. But overall it seems fairly reliable and *buttery smooth!*