

Jackscrews

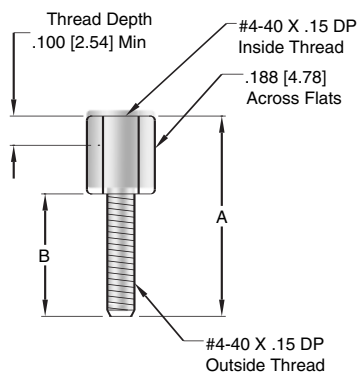

JACKSCREW DIMENSIONS		
PART NUMBER	A	B
JS-01	.416 [10.60]	.226 [5.70]
JS-02	.467 [11.86]	.270 [6.86]
JS-03	.500 [12.70]	.313 [7.95]
JS-04	.465 [11.81]	.226 [5.70]

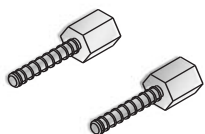

HDW-031

Set includes 2 #4-40 female jackscrews

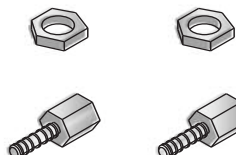

HDW-024

Set includes 2 #4-40 female jackscrews and 2 hex nuts

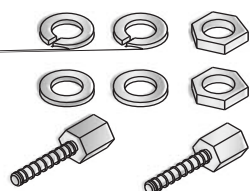

HDW-023

Set includes 2 #4-40 female jackscrews 2 flat washers, 2 split washers and 2 hex nuts

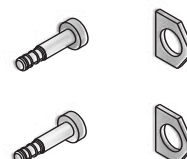

HDW-028

Screw retainer clip set includes 2 screw retainer clips and 2 retainer screws

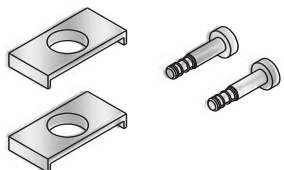

HDW-029

Screw lock kit includes 2 screw locks and 2 retainer screws



HDW-044

Sliding lock posts
Set of 2

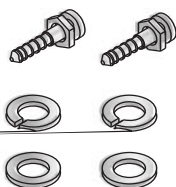

HDW-043A

Slide lock post set includes 2 posts, washers and lock-washers

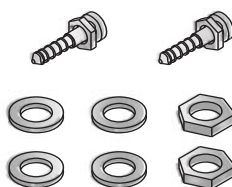

HDW-045

Slide lock post kit includes 2 posts, washers and hex nuts

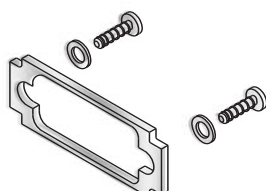

HDW-043-XX

Slide lock assembly kit includes slide lock, screws and washers, Specify 9, 15, 25 or 37 position

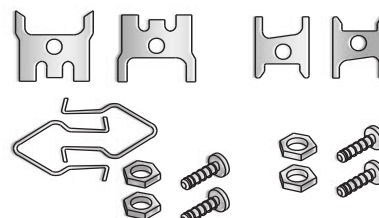

HDW-041

Spring latch set includes 1 pair of spring latches, with holding hardware and 1 pair of notch clips, with holding hardware