

Modular APD System

Altech's modular Power Distribution (APD) System is a new way to simplify existing wiring methods!

The modular APD system provides flexible solutions for busing common power to many different electrical components. Components can be easily added or removed using quick disconnects saving valuable time and cost during installation and maintenance. The APD system also provides an organized method of wiring, that would simplify the wiring schematics for troubleshooting, while reducing the use of excessive wires and cables.

The APD system allows multiple connections per phase for many applications, such as:

- Supplying separate voltages to auxiliary circuits and control circuits for relays, contactors, timers, etc.
- Supplying power to circuit breakers, motor starters, switches, contactors, etc.

Two conductors are housed within a rigid plastic insulation housing suitable for voltages up to 600VAC. The conductors have current ratings of 25A, 63A or 80A.

The entire system is touch proof (IP20).

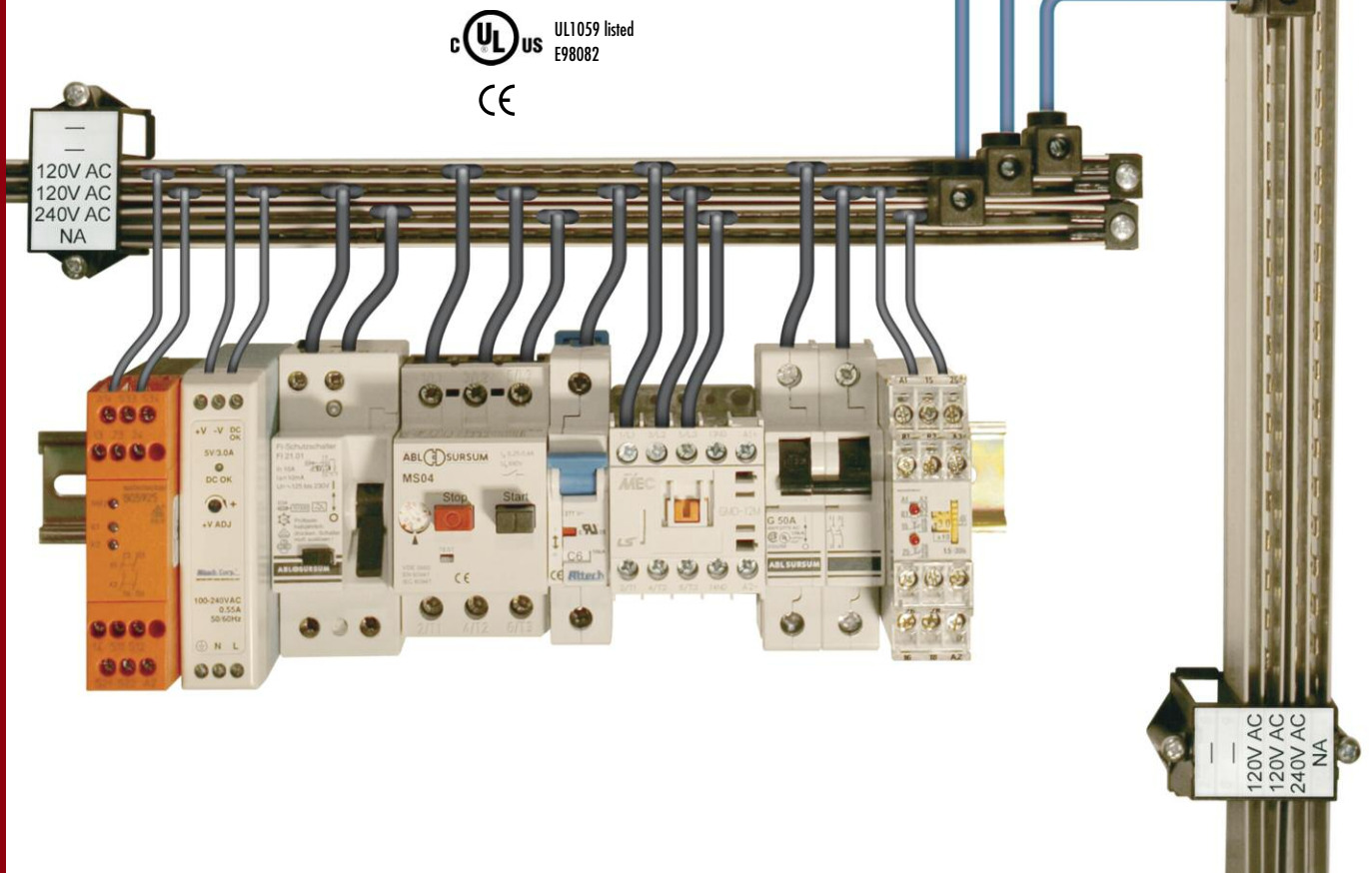

APD BUSBARS

Specifications:

APD Busbars are available with 1 or 2 phases, Max. Temperature 158°F (70°C)

Material Insulation:

PVC

Length:

1.9m (6.23 ft.)/ 1.0m (3.281 ft.)

83 Connections per Meter per Phase

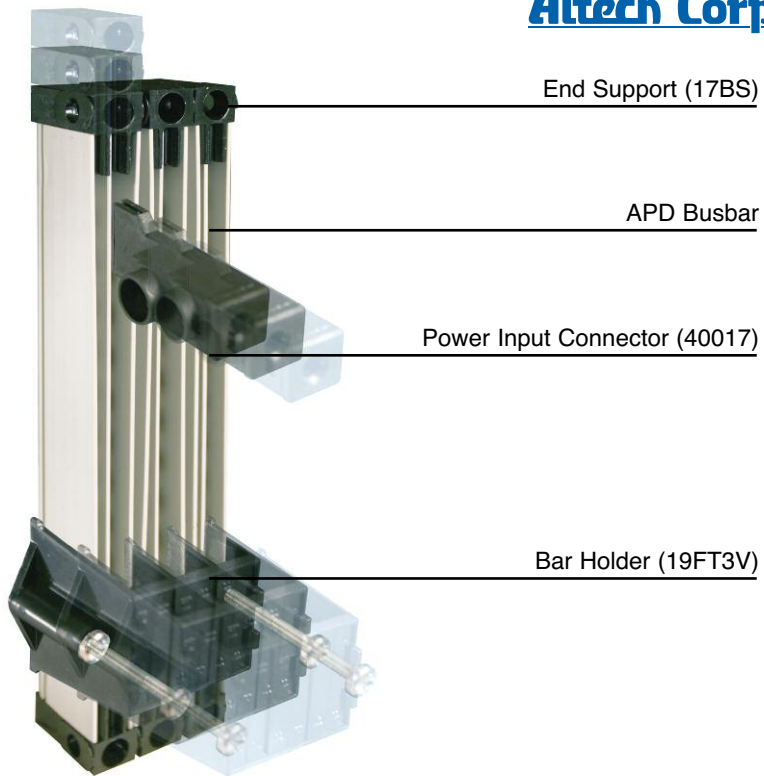

Electrical Rating (600VAC)	Part No.	Possible Connections / Phase	No. of Phases	Material	Length
25A	1LB158-25A	158	1	Brass	1.9m (6.23 ft.)
25A	2LB158-25A	158	2	Brass	1.9m (6.23 ft.)
25A	1LB83-25A	83	1	Brass	1.0m (3.281 ft.)
25A	2LB83-25A	83	2	Brass	1.0m (3.281 ft.)
63A	1TC158-63A	158	1	Tinned Copper	1.9m (6.23 ft.)
63A	2TC158-63A	158	2	Tinned Copper	1.9m (6.23 ft.)
63A	1TC83-63A	83	1	Tinned Copper	1.0m (3.281 ft.)
63A	2TC83-63A	83	2	Tinned Copper	1.0m (3.281 ft.)
80A	1TC158-80A	158	1	Tinned Copper	1.9m (6.23 ft.)
80A	2TC158-80A	158	2	Tinned Copper	1.9m (6.23 ft.)
80A	1TC83-80A	83	1	Tinned Copper	1.0m (3.281 ft.)
80A	2TC83-80A	83	2	Tinned Copper	1.0m (3.281 ft.)

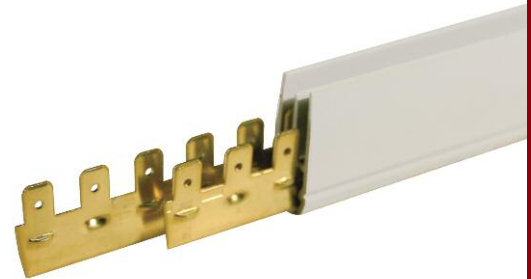
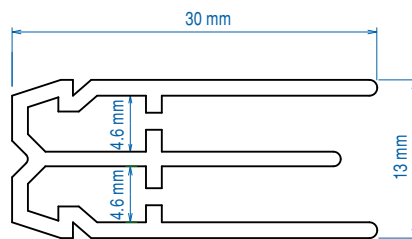

Technical Note:

The standard busbar lengths can be cut to any desirable length. When cutting the busbars remember to cut the conductor 62mm shorter than the insulation to ensure space for the insulation cap (Part No. 17BI0) at each end. This guarantees adequate and required creepage distance (see picture below). If an end support (Part No. 17BS) is used then no insulation cap is needed.



FIXING AND MOUNTING

Bar-Holder



Part No.	19FT3V
Material including	Noryl 2 Screws M4x30mm built-in insulation cap

The holder can accommodate up to 3 Busbars (6 conductor circuits)



Holders should be set approx. every 500mm (19.69 in.). For each Busbar to be fixed cut 2 braces out of the holder, keep the others to assure stability

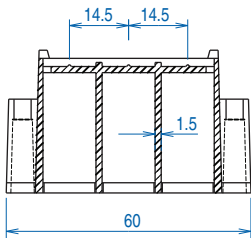

Insulation Cap



Part No.	17BIO
Material	PVC
Length	30 mm

Slide in insulation cap from the side into insulation.

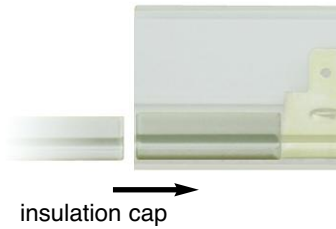

Busbar Holder Marking Set

Part No.	17EET
Material	cover -PVC label - Paper



The bar-holder has engraved numerical identification from 1-12. The bar-holder can also accommodate 42x25 mm (1.65 x 0.98 in.) labels and a transparent protection cover. This marking-set is available as part no. 17EET; it contains one label with 6 positions for marking and one transparent cover in PVC.

End Support



Part No.	17BS
Material including	Noryl Screw M4x25

If an end support is used, no insulation cap (Part No. 17BIO) is necessary

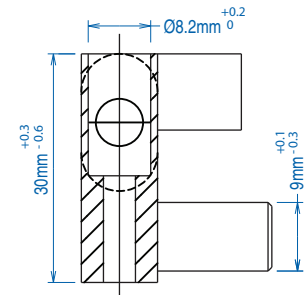

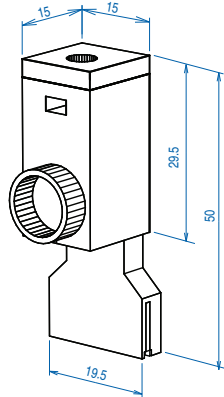

Power Input Connector

Part No. 40017
Material Copper/Steel
Clamp 8-2AWG (10-25mm²)
Wire Size 90A (600VAC)
Electrical Rating

The Power Input Connector is optional. It can accommodate wires from 8 to 2AWG and is used for circuits up to 90A.

90A can be distributed over a 63A APD Busbar by using the Power Input Connector as a feeder in the center of the busbar.

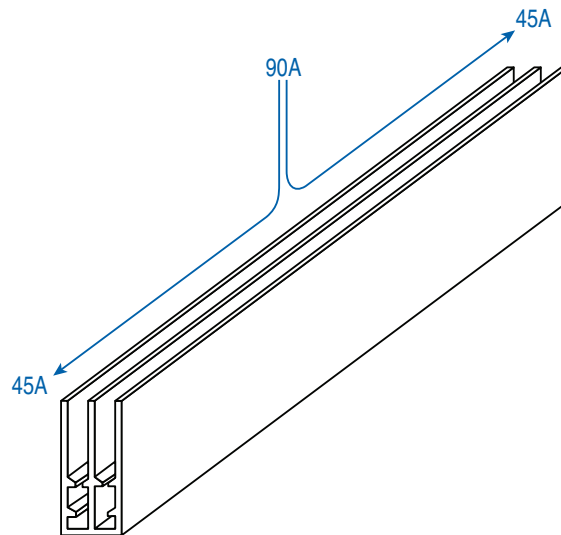

Note: Standard Female Quick Disconnects (0.250 x 0.032 in.) can be used for power feeding and between-busbar connections of up to 30A. Power Input Connectors (Part No. 40017) are only necessary for currents greater than 30A.

Connection of Branch Circuits

The APD Busbar have standard pins (6.3mm x 0.8mm) for female disconnects every 12mm. 83 disconnects are available per meter.

Standard 0.250 in. female disconnects can be used for connections to achieve the following current ratings:

- 30A with 10AWG wire
- 20A with 12AWG wire
- 15A with 14AWG wire
- 10A with 16AWG wire

