

Feed-Through

Altech "U" Series Universal Rail Mounting Standard Screw Clamp Feed through terminals are the most versatile terminals for wire-to-wire connection in control, automation, instrumentation and power distribution applications. A special design feature on the flexible foot enables easy mounting and dismantling from the DIN Rail with the help of a screwdriver.

The CTC4U Tab Connection terminals offer quick connection possibility. These terminal blocks are suited for standard 'Fast On' type lugs.

The connection is achieved by pushing the lug / ferrule onto the tab blade of the terminal block.

CTC4U is used primarily in railway systems.

A nice alternative to 'Fast On' style barrier strips.

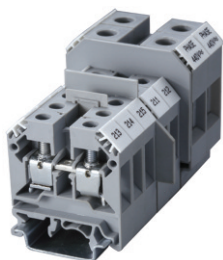

	CTS2.5U-N			CTS4U-N			CTC4U	
Terminal Width	5 mm			6 mm				
Height x Length	45 x 43 mm			45 x 43 mm			49.5 x 47 mm	
Stripping Length	8 mm			8 mm			9 mm	
Insulation Material	Polyamide 6.6			Polyamide 6.6			Polyamide 6.6	
Type of Connection	2 screw clamps & 1 tapped hole for cross connect.			2 screw clamps & 1 tapped hole for cross connect.			5 tab connection points and 1 tapped hole for cross connection	
Approvals								
Wire Range	22-12 AWG	0.2-2.5 sq.mm	22-12 AWG	22-10 AWG	0.2-4 sq.mm	22-10 AWG		
Rated Cross Section	1 conductor per clamp 2 same size conductors						0.25-4.0 sq.mm 24-12 AWG 0.25-2.5 sq.mm 24-12 AWG	
Voltage Rating	600 V	1000 V	600 V	600 V	1000 V	600 V	300 V	
Current Rating	25 A	24 A	25 A	35/40 A*	32 A	35/40A*	32 A	
Torque	7 lb-in	0.4 Nm	7 lb-in	7 lb-in	0.5 Nm	7 lb-in		
Tab Blade Size							6.3 x 0.8	

Other Approvals								
	Cat. No.	Std. Pk.	Cat. No.	Std. Pk.	Cat. No.	Std. Pk.	Cat. No.	Std. Pk.

Terminal Block	CTS2.5U-N	100	CTS4U-N	100	CTS4U	100
----------------	-----------	-----	---------	-----	-------	-----

End Plate	EP2.5/4UN	50	EP2.5/4UN	50	EPCTC4U	50
-----------	-----------	----	-----------	----	---------	----

Isolation Partition	PP2.5/4UN	50	PP2.5/4UN	50		
---------------------	-----------	----	-----------	----	--	--

Separator Plate	SP2.5/4UN	100	SP2.5/4UN	100		
-----------------	-----------	-----	-----------	-----	--	--

DIN Rail for ordering information refer to pages 90-91						
--	--	--	--	--	--	--

End Stop for ordering info. refer to page 92	CA702	50	CA702	50	CA702	50
	CA802	50	CA802	50	CA802	50

Internal Jumper	2 pole	CA721/2	100	CA722/2	100	CA727/2	100
	3 pole <td>CA721/3</td> <td>50</td> <td>CA722/3</td> <td>50</td> <td>CA727/3</td> <td>50</td>	CA721/3	50	CA722/3	50	CA727/3	50
	4 pole <td>CA721/4</td> <td>50</td> <td>CA722/4</td> <td>50</td> <td>CA727/4</td> <td>50</td>	CA721/4	50	CA722/4	50	CA727/4	50
	10 pole <td>CA721/10</td> <td>10</td> <td>CA722/10</td> <td>10</td> <td>CA727/10</td> <td>10</td>	CA721/10	10	CA722/10	10	CA727/10	10
	100 pole <td>CA721/100</td> <td>10</td> <td>CA722/100</td> <td>10</td> <td></td> <td></td>	CA721/100	10	CA722/100	10		

Insulated Internal Jumper	2 pole	CA741/2	100	CA742/2	100	CA747/2	100
	3 pole <td>CA741/3</td> <td>50</td> <td>CA742/3</td> <td>50</td> <td>CA747/3</td> <td>50</td>	CA741/3	50	CA742/3	50	CA747/3	50
	4 pole <td>CA741/4</td> <td>50</td> <td>CA742/4</td> <td>50</td> <td>CA747/4</td> <td>50</td>	CA741/4	50	CA742/4	50	CA747/4	50
	10 pole <td>CA741/10</td> <td>10</td> <td>CA742/10</td> <td>10</td> <td>CA747/10</td> <td>10</td>	CA741/10	10	CA742/10	10	CA747/10	10
	100 pole <td>CA741/100</td> <td>10</td> <td>CA742/100</td> <td>10</td> <td></td> <td></td>	CA741/100	10	CA742/100	10		

Current Bars	2 pole	CA703/01	100	CA703/01	100	CA703/1	100
	3 pole <td>CA704/01 <td>100</td> <td>CA704/01 <td>100</td> <td>CA704/1 <td>100</td> </td></td></td>	CA704/01 <td>100</td> <td>CA704/01 <td>100</td> <td>CA704/1 <td>100</td> </td></td>	100	CA704/01 <td>100</td> <td>CA704/1 <td>100</td> </td>	100	CA704/1 <td>100</td>	100
	4 pole <td>CA705/01 <td>100</td> <td>CA705/01 <td>100</td> <td>CA705/1 <td>100</td> </td></td></td>	CA705/01 <td>100</td> <td>CA705/01 <td>100</td> <td>CA705/1 <td>100</td> </td></td>	100	CA705/01 <td>100</td> <td>CA705/1 <td>100</td> </td>	100	CA705/1 <td>100</td>	100
	10 pole <td>CA731/10 <td>100</td> <td>CA732/10 <td>100</td> <td>CA732/10 <td>100</td> </td></td></td>	CA731/10 <td>100</td> <td>CA732/10 <td>100</td> <td>CA732/10 <td>100</td> </td></td>	100	CA732/10 <td>100</td> <td>CA732/10 <td>100</td> </td>	100	CA732/10 <td>100</td>	100
	10 pole (breakable)	—		CA732/10-A <td>100</td> <td>CA732/10-A <td>100</td> </td>	100	CA732/10-A <td>100</td>	100
	100 pole <td>CA731/100 <td>10</td> <td>CA732/100 <td>10</td> <td>CA732/100 <td>10</td> </td></td></td>	CA731/100 <td>10</td> <td>CA732/100 <td>10</td> <td>CA732/100 <td>10</td> </td></td>	10	CA732/100 <td>10</td> <td>CA732/100 <td>10</td> </td>	10	CA732/100 <td>10</td>	10

Shorting Sleeve & Screw	CA 707/S/Q/01	100	CA 707/S/Q/01	100	CA807/S/Q/01	100
-------------------------	---------------	-----	---------------	-----	--------------	-----

External Jumper	2 pole	CA717/2	100	CA714/2	100	CA707/TS/01	100
	3 pole <td>CA717/3 <td>100</td> <td>CA714/3 <td>100</td> <td></td> <td></td> </td></td>	CA717/3 <td>100</td> <td>CA714/3 <td>100</td> <td></td> <td></td> </td>	100	CA714/3 <td>100</td> <td></td> <td></td>	100		
	4 pole <td>CA717/4 <td>100</td> <td>CA714/4 <td>100</td> <td></td> <td></td> </td></td>	CA717/4 <td>100</td> <td>CA714/4 <td>100</td> <td></td> <td></td> </td>	100	CA714/4 <td>100</td> <td></td> <td></td>	100		
	10 pole <td>CA717/10 <td>25</td> <td>CA714/10 <td>25</td> <td></td> <td></td> </td></td>	CA717/10 <td>25</td> <td>CA714/10 <td>25</td> <td></td> <td></td> </td>	25	CA714/10 <td>25</td> <td></td> <td></td>	25		

Test Socket					CA707/TS/01	100
-------------	--	--	--	--	-------------	-----

Marking Tags		MT5	100	MT6	100	MT6	100
--------------	--	-----	-----	-----	-----	-----	-----

Mounting Handle

See page 91.



COLOR BLOCKS
(other than standard grey)

When ordering please add color suffix to Cat. No.

Example for color Red: **Cat.No./R**

Color	Ordering Suffix
Red	R
Yellow	Y
Blue	BU
Green	G

Consult Altech for availability:

Orange	O
Beige	BG
Dark Brown	DB
Black	BL
White	W

* 35A with one No. 10 AWG and 40A with two No. 12 AWG wires.

CTS6U



8 mm

47 x 43 mm

9 mm

Polyamide 6.6

2 screw clamps & 1 tapped hole for cross connect.

C US	60947-7-1	C US
	E220514	
22-8 AWG	0.5-6 sq.mm	22-8 AWG
600 V	1000 V	600 V
50 A	41 A	50 A
14 lb-in	0.8 Nm	14 lb-in



Cat. No.	Std. Pk.
CTS6U	50
EP6/10U	50
PP6/10U	50
SP6/10U	100



CA702	50
CA802	50

CA723/2	100
CA723/3	50
CA723/4	50
CA723/10	10

CA743/2	100
CA743/3	50
CA743/4	50
CA743/10	10

CA703/2	100
CA704/2	100
CA705/2	100
CA733/10	100

CA707/S/Q/1	100
-------------	-----

CA710/2	100
CA710/3	100
CA710/4	100
CA710/10	25

MT8	100
-----	-----

CTS10U

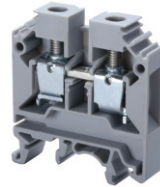

10 mm

47 x 43 mm

11 mm

Polyamide 6.6

2 screw clamps & 1 tapped hole for cross connect.

C US	60947-7-1	C US
	E220514	
22-6 AWG	0.5-10 sq.mm	16-6 AWG
600 V	1000 V	600 V
65 A	57 A	65 A
14 lb-in	1.2 Nm	14 lb-in



Cat. No.	Std. Pk.
CTS10U	50
EP6/10U	50
PP6/10U	50
SP6/10U	100



CA702	50
CA802	50

CA724/2	100
CA724/3	50
CA724/4	50
CA724/10	10

CA744/2	100
CA744/3	50
CA744/4	50
CA744/10	10

CA703/3	100
CA704/3	100
CA705/3	100
CA734/10	100

CA707/S/Q/01	100
--------------	-----

CA718/2	100
CA718/3	50
CA718/4	50
CA718/10	25

MT10	100
------	-----

CTS16U



12 mm

47 x 43 mm

12 mm

Polyamide 6.6

2 screw clamps & 1 tapped hole for cross connect.

C US	60947-7-1	C US
	E220514	
22-6 AWG	0.2-16 sq.mm	20-4 AWG
600 V	1000 V	600 V
70 A	76 A	85 A
14 lb-in	1.2 Nm	14 lb-in



Cat. No.	Std. Pk.
CTS16U	50
EP6/10U	
PP6/10U	
SP6/10U	100



CA702	50
CA802	50

CA751/2	50
CA751/3	50
CA751/4	50
CA751/10	10

CA761/2	50
CA761/3	50
CA761/4	50
CA761/10	10

CA703/8	100
CA704/8	100
CA705/8	100
CA739/10	100

CA707/S/Q/1	100
-------------	-----

MT12	100
------	-----

CTS25U

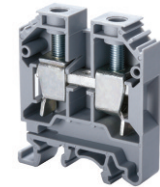

12 mm

56 x 49 mm

14 mm

Polyamide 6.6

2 screw clamps & 1 tapped hole for cross connect.

C US	60947-7-1	C US
	E220514	
12-2 AWG	4-25 sq.mm	14-2 AWG
600 V	1000 V	600 V
115 A	101 A	115 A
35 lb-in	2.0 Nm	25 lb-in



Cat. No.	Std. Pk.
CTS25U	50
EP25U	
PP25U	50
SP25U	



CA702	50
CA802	50











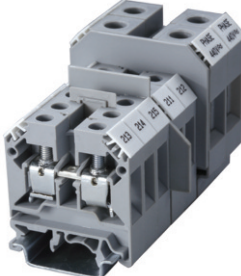

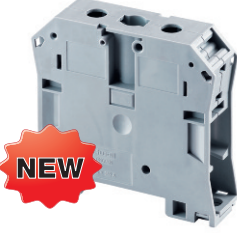
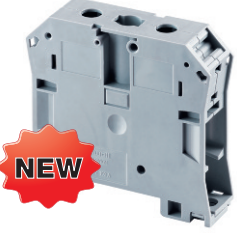
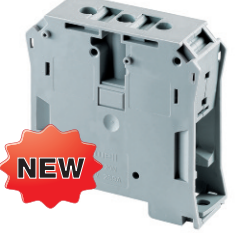









CA725/2	50
CA725/3	25
CA725/4	25
CA725/10	10

CA745/2	50
CA745/3	25
CA745/4	25
CA745/10	10

CA703/4	100
CA704/4	100
CA705/4	100
CA735/10	100

CA707/S/Q/2	100
-------------	-----

MT12	100
------	-----

	CTS35UN			CTS50/70N			CTS50/70NA			CTS95/120N		
												
Terminal Width	16 mm			20.5 mm			25 mm			25 mm		
Height x Length	58 x 50.5 mm			75.5 x 71 mm			90 x 83 mm			90 x 83 mm		
Stripping Length	15 mm			22 mm			24 mm			24 mm		
Insulation Material	Polyamide 6.6			Polyamide 6.6			Polyamide 6.6			Polyamide 6.6		
Type of Connection	2 screw clamps & 1 tapped hole for cross			2 screw clamp connections			2 screw clamp connections			2 screw clamp connections		
Approvals												
Wire Range	12-2 AWG	4-35 sq.mm	12-2 AWG	8-2/0 AWG	10-70 sq.mm	8-2/0 AWG	8-2/0 AWG	10-70 sq.mm	8-2/0 AWG	2-250 KCMIL	25-120 sq.mm	2-250 KCMIL
Voltage Rating	600 V	1000 V	600 V	1000V	1000 V	1000 V	1000V	1000 V	1000 V	1000V	1000 V	1000 V
Current Rating	130 A	125 A	130 A	175 A	192 A	175 A	175 A	192 A	175 A	240 A	269 A	240 A
Torque	25 lb-in	2.5 Nm	25 lb-in	38 lb-in	3 Nm	38 lb-in	38 lb-in	3 Nm	38 lb-in	90 lb-in	6 Nm	90 lb-in
Other Approvals												
Terminal Block	Cat. No.	Std. Pk.	Cat. No.	Std. Pk.	Cat. No.	Std. Pk.	Cat. No.	Std. Pk.	Cat. No.	Std. Pk.	Cat. No.	Std. Pk.
	CTS35UN	50	CTS50/70N	10	CTS50/70NA	10	CTS95/120N	10				
Isolation Partition 	PP35UN	50										
DIN Rail for ordering information refer to pages 90-91												
End Stop for ordering info. refer to page 92 	CA702 CA802	50 50	CA202 CA102	50 50	CA202 CA102	50 50	CA202 CA102	50 50	CA202 CA102	50 50		
Internal Jumper 	2 pole 3 pole 4 pole 10 pole 100 pole	CA771/2 CA771/3 CA771/4 CA771/10	50 25 25 10									
Insulated Internal Jumper 	2 pole 3 pole 4 pole 10 pole	CA781/2 CA781/3 CA781/4 CA781/10	50 25 25 10									
Current Bars 	2 pole 3 pole 4 pole 10 pole 10 pole (breakable) 100 pole	CA703/10 CA704/10 CA705/10 CA770/10	100 100 100 100									
Shorting Link System 			CA628/2 CA628/3	10 10	CA628/2 CA628/3	10 10	CA628/2 CA628/3	10 10	CA629/2 CA629/3	10 10		
Shorting Sleeve & Screw 	CA707/S/Q/2	100										
Marking Tags 	MT16	100	MT16	100	MT16	100	MT16	100	MT16	100		

AUX6

Auxiliary Terminal Block

Used for:

- CTS50/70N
- CTS50/70NA
- CTS95/120N

Wire Range 22-8 AWG

In certain power circuits, there is a need to take an extra connection for an Auxiliary circuit like an indicating light or contactor. The AUX6 terminal easily plugs into the terminal and provides this extra connection point.











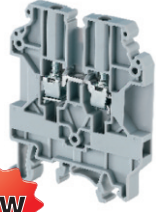
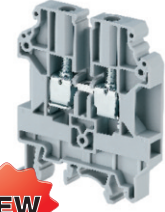
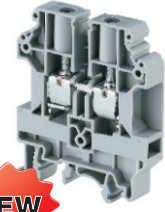















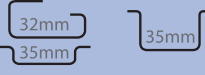

Ratings As Per

- IEC60947-7-1
Voltage/Current: 1000 V / 41 A
Torque: 0.8 Nm
- IEC 60079-7
Voltage/Current: 630 V / 36 A
Torque: 0.8 Nm
- UL-1059
Voltage/Current: 600 V / 50 A
Torque: 14 lb-in
- CSA22.2-158
Voltage/Current: 600 V / 50 A
Torque: 14 lb-in
- Width x Length x Height**
8 x 53.6 x 29.4 mm
- Std. Pk.:** 10
- Marking Tag:** MT8

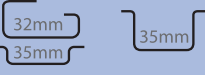
The CHV series Terminal Blocks have been specially designed for high voltage use, such as in solar applications.

A specially designed flexible foot enables easy mounting and dismounting from the mounting rail with the help of a screw driver. These Terminal Blocks have marker holding recesses to accept marking tags for circuit identification. Cross connection can be achieved with the aid of shorting links / sleeves & screws.

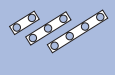
	CHV4U		CHV6U			CHV10U			
									
									
Terminal Width	6 mm		8 mm			10 mm			
Height x Length	70.8 x 52 mm		70.8 x 52 mm			70.8 x 52 mm			
Stripping Length	12 mm		14 mm			14 mm			
Insulation Material	Polyamide 6.6		Polyamide 6.6			Polyamide 6.6			
Approvals	 		 			 			
Wire Range	22-10 AWG	0.2-4 sq.mm	22-10 AWG	22-8 AWG	0.2-6 sq.mm	22-8 AWG	20-6 AWG	0.2-10 sq.mm	22-6 AWG
Voltage Rating	1000 V	1000 V	1000 V	1000 V	1000 V	1000 V	1000 V	1000 V	1000 V
Current Rating	35 A	32 A	35 A	50 A	41 A	50 A	65 A	57 A	65 A
Torque	7 lb-in	0.5 Nm	7 lb-in	14 lb-in	0.8 Nm	14 lb-in	14 lb-in	1.2 Nm	14 lb-in
Other Approvals	 		 			 			

		Cat. No.	Std. Pk.	Cat. No.	Std. Pk.	Cat. No.	Std. Pk.
Terminal Block		CHV4U	100	CHV6U	100	CHV10U	100
End Plate		EPUSC	50	EPUSC	50	EPUSC	50
Separator Plate		SP2.5/4UN	50	SP2.5/4UN	50	SP2.5/4UN	50
DIN Rail for ordering information refer to pages 90-91							
End Stop for ordering info. refer to page 92		CA702 CA802	50 50	CA702 CA802	50 50	CA702 CA802	50 50
Internal Jumper		2 pole CA623/2 3 pole CA623/3 4 pole CA623/4 10 pole CA623/10	100 100 100 10	2 pole CA624/2 3 pole CA624/3 4 pole CA624/4 10 pole CA624/10	100 100 100 10	2 pole CA625/2 3 pole CA625/3 4 pole CA625/4 10 pole CA625/10	100 100 100 10
Insulated Internal Jumper		2 pole CA643/2 3 pole CA643/3 4 pole CA643/4 10 pole CA643/10	100 100 100 10	2 pole CA644/2 3 pole CA644/3 4 pole CA644/4 10 pole CA644/10	100 100 100 10	2 pole CA645/2 3 pole CA645/3 4 pole CA645/4 10 pole CA645/10	100 100 100 10
Current Bars		2 pole CA703/1 3 pole CA704/1 4 pole CA705/1 10 pole CA732/10	100 100 100 100	2 pole CA703/2 3 pole CA704/2 4 pole CA705/2 10 pole CA733/10	100 100 100 100	2 pole CA703/3 3 pole CA704/3 4 pole CA705/3 10 pole CA734/10	100 100 100 100
Short Sleeve & Screw		CA608/S/Q	100	CA609/S/Q	100	CA610/S/Q	100
Marking Tags		MT6	100	MT8	100	MT10	100

Feed-Through Multi-Connection

Connect multiple wires to a single terminal block and eliminate reliability problems encountered when connecting two wires into a single clamp. Two versions are available.

Type CMC1-2 features a single screw-cage clamp for 22-10 AWG wires on one side and two clamps on the other side for 22-10 AWG wires.

Type CMC2-2 has two identical clamps for 22-10 AWG wires on both sides. Having 2 internal jumper ports makes jumping every other pole convenient.

	CMC1-2			CMC2-2		
Terminal Width	6 mm			6 mm		
Height x Length	47 x 46.5 mm			51.5 x 65 mm		
Stripping Length	9 mm			9 mm		
Insulation Material	Polyamide 6.6			Polyamide 6.6		
Type of Connection	3 screw clamps & 1 tapped hole for cross connection			4 screw clamps & 2 tapped holes for cross connection		
Approvals						
Wire Range	22-10AWG	0.2-4 sq.mm	22-10 AWG	22-10 AWG	0.2-4 sq.mm	22-10 AWG
Voltage Rating	600 V	630 V	600 V	600 V	630 V	600 V
Current Rating	35 A	32 A	35 A	35 A	32 A	35 A
Torque	7 lb-in.	0.5 Nm	7 lb-in.	7 lb-in.	0.5 Nm	7 lb-in.
Other Approvals						
	Cat. No.	Std. Pk.		Cat. No.	Std. Pk.	
Terminal Block	CMC1-2	100		CMC2-2	50	
End Plate	EPCMC1-2	50		EPCMC2-2	50	
DIN Rail for ordering information refer to pages 90-91						
End Stop for ordering information refer to page 92	CA702	50		CA702	50	
	CA802	50		CA802	50	
Internal Jumper	2 pole	CA722/2	100	CA722/2	100	
	3 pole	CA722/3	50	CA722/3	50	
	4 pole	CA722/4	50	CA722/4	50	
	10 pole	CA722/10	10	CA722/10	10	
	100 pole	CA722/100	5	CA722/100	5	
Insulated Internal Jumper	2 pole	CA742/2	100	CA742/2	100	
	3 pole	CA742/3	50	CA742/3	50	
	4 pole	CA742/4	50	CA742/4	50	
	10 pole	CA742/10	10	CA742/10	10	
	100 pole	CA742/100	5	CA742/100	5	
Current Bars	2 pole	CA703/1	100	CA703/1	100	
	3 pole	CA704/1	100	CA704/1	100	
	4 pole	CA705/1	100	CA705/1	100	
	10 pole	CA732/10	100	CA732/10	100	
	10 pole (breakable)	CA732/10-A	100	CA732/10-A	100	
	100 pole	CA732/100	10	CA732/100	10	
Shorting Sleeve & Screw		CA707/S/Q/01	100	CA707/S/Q/01	100	
External Jumper	2 pole	CA714/2	100	CA714/2	100	
	3 pole	CA714/3	100	CA714/3	100	
	4 pole	CA714/4	50	CA714/4	50	
	10 pole	CA714/10	25	CA714/10	25	
Marking Tags		MT6	100	MT6	100	

COLOR BLOCKS
(other than standard grey)

When ordering please add color suffix to Cat. No.
Example for color Red: **Cat.No./R**

Color	Ordering Suffix
Red	R
Yellow	Y
Blue	BU
Green	G

Consult Altech for availability:

Orange	O
Beige	BG
Dark Brown	DB
Black	BL
White	W

Altech double level terminals are the answer to high wiring density problems posed by certain unavoidable wiring arrangements. Double level terminals have the following advantages:

- Double wiring density available without extension of mounting rails.
- Interconnection/shorting can be done at both levels.
- Marking/identification by marking tags possible at both levels.

CDL4UN(I.S) internally shorted double level terminals are useful for distribution applications by using shorting links at lower levels.

Now uses larger MT6 tag for easier visibility.

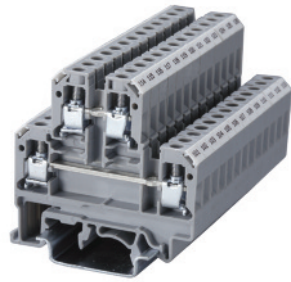

Feed-Through Double Level

CDL4UN	CDL4UN(I.S)
--------	-------------

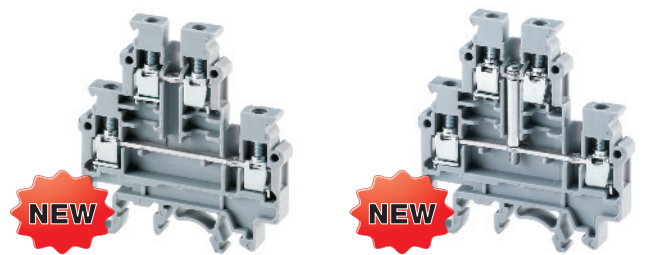

Terminal Width	6 mm			6 mm		
Height x Length	54 x 55.5 mm			54 x 55.5 mm		
Stripping Length	9 mm			9 mm		
Insulation Material	Polyamide 6.6			Polyamide 6.6		
Type of Connection	4 screw clamps & 2 tapped holes for cross connection			4 screw clamps & 1 tapped hole for cross connection		
Approvals						
Wire Range	22-10 AWG	0.2-4 sq.mm	22-10 AWG	22-10 AWG	0.2-4 sq.mm	22-10 AWG
Voltage Rating	600V	800 V	600 V	600 V	800 V	600 V
Current Rating	35 A	32 A	35 A	35 A	32 A	35 A
Torque	7 lb-in	0.5 Nm	7 lb-in	7 lb-in	0.5 Nm	7 lb-in



Cat. No.	Std. Pk.	Cat. No.	Std. Pk.
----------	----------	----------	----------

Terminal Block		CDL4UN	Std. Pk.	CDL4UN(I.S)	Std. Pk.
End Plate		EPCDL4UN	50	EPCDL4UN	50
Separator Plate		SPCDL4U	100	SPCDL4U	100
DIN Rail	for ordering information refer to pages 90-91				
End Stop	for ordering information refer to page 92	CA702 CA802	50 50	CA702 CA802	50 50
Internal Jumper	 2 pole 3 pole 4 pole 10 pole	CA722/2 CA722/3 CA722/4 CA722/10	100 50 50 10	CA722/2 CA722/3 CA722/4 CA722/10	100 50 50 10
Insulated Internal Jumper	 2 pole 3 pole 4 pole 10 pole	CA742/2 CA742/3 CA742/4 CA742/10	100 50 50 10	CA742/2 CA742/3 CA742/4 CA742/10	100 50 50 10
Current Bars	 2 pole 3 pole 4 pole 10 pole 10 pole (breakable) 10 pole	CA703/1 CA704/1 CA705/1 CA732/10 CA732/10-A CA732/100	100 100 100 100 100 10	CA703/1 CA704/1 CA705/1 CA732/10 CA732/10-A CA732/100	100 100 100 100 100 10
Shorting Sleeve & Screw		CA707/S/Q/01	100	CA607/S/Q	100
External Jumper	 2 pole 3 pole 4 pole 10 pole	CA714/2 CA714/3 CA714/4 CA714/10	100 100 50 25	CA714/2 CA714/3 CA714/4 CA714/10	100 100 50 25
Marking Tags		MT6	100	MT6	100

COLOR BLOCKS
(other than standard grey)

When ordering please add color suffix to Cat. No.
Example for color Red: **Cat.No./R**

Color	Ordering Suffix	
Red	R	
Yellow	Y	
Blue	BU	
Green	G	
Consult Altech for availability:		
Orange	O	
Beige	BG	
Dark Brown	DB	
Black	BL	
White	W	

Feed-Through Offset Double Level

Altech Offset Double Level Terminals provide a separate connection at two levels. In ODL, the top level is offset from the bottom level by half the thickness of the terminal.

This offset provides better accessibility to the screws on the lower level.

It is recommended to use end plates at both ends of assembled ODL terminal sets for flat alignment to enable effective use of end stops.

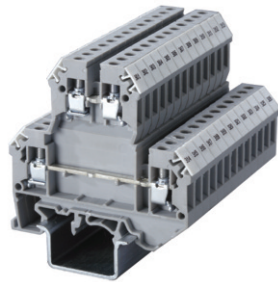

ODL4U

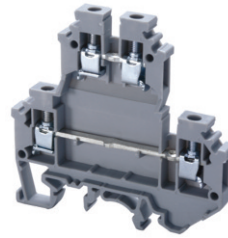

Terminal Width	6 mm		
Height x Length	63 x 68 mm		
Stripping Length	9 mm		
Insulation Material	Polyamide 6.6		
Type of Connection	4 screw clamps & 2 tapped holes for cross connection		
Approvals			
Wire Range	22-10 AWG	0.2-4 sq.mm	22-10 AWG
Voltage Rating	600 V	800 V	600 V
Current Rating	35 A	32 A	35 A
Torque	7 lb-in	0.5 Nm	7 lb-in

Other Approvals					
-----------------	--	--	--	--	--

Cat. No.	Std. Pk.
----------	----------

Terminal Block	ODL4U	50
End Plate		
Front	EPODL4U	50
Back	EP1ODL4U	50

DIN Rail		
for ordering information refer to pages 90-91		

End Stop		
for ordering information refer to page 92		
CA702	50	
CA802	50	

Internal Jumper		2 pole	CA727/2	10
		3 pole	CA727/3	10
		4 pole	CA727/4	10
		10 pole	CA727/10	10

Insulated Internal Jumper		2 pole	CA747/2	100
		3 pole	CA747/3	50
		4 pole	CA747/4	50
		10 pole	CA747/10	10

Current Bars		2 pole	CA703/1	100
		3 pole	CA704/1	100
		4 pole	CA705/1	100
		10 pole	CA732/10	100
		10 pole (breakable)	CA732/10-A	100
		100 pole	CA732/100	10

Shorting Sleeve & Screw		CA607/S/Q	100
-------------------------	--	-----------	-----

External Jumper		2 pole	CA714/2	100
		3 pole	CA714/3	100
		4 pole	CA714/4	50
		10 pole	CA714/10	25

Marking Tags		MT6	100
--------------	--	-----	-----

COLOR BLOCKS
(other than standard grey)

When ordering please add color suffix to Cat. No.
Example for color Red: **Cat.No./R**

Color	Ordering Suffix
Red	R
Yellow	Y
Blue	BU
Green	G
Orange	O
Beige	BG
Dark Brown	DB
Black	BL
White	W

Consult Altech for availability.

For applications with extreme space constraints. Only 6mm (.236") wide, with three separate feed-through levels. Jumpers can be used to reduce field wiring.

They can also be used in control systems where sensors and actuator applications are involved.

The top level of CTL2.5U-H terminal block provide connecting points for signal while middle and bottom level provide connecting points are used for positive and negative potential.

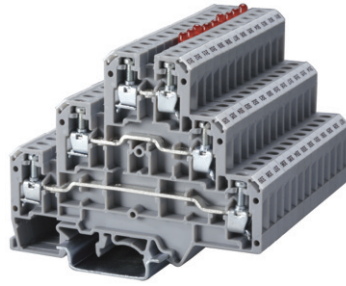

CTL2.5U-H

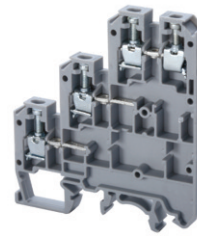

CTL2.5U

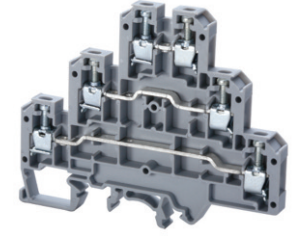

Terminal Width	6 mm			6 mm		
Height x Length	67 x 61 mm			67 x 84 mm		
Stripping Length	9 mm			9 mm		
Insulation Material	Polyamide 6.6			Polyamide 6.6		
Type of Connection	4 Screw clamps & 3 tapped holes for cross connect.			6 Screw clamps & 3 tapped holes for cross connect.		
LED Voltage						
Approvals						
Wire Range	22-12 AWG	0.2-2.5 sq.mm	22-12 AWG	22-12 AWG	0.2-2.5 sq.mm	22-12 AWG
Voltage Rating	300 V	500 V	300 V	300 V	500 V	300 V
Current Rating	25 A	24 A	25 A	25 A	24 A	25 A
Torque	4.5 lb-in	0.4 Nm	4.5 lb-in	4.5 lb-in	0.4 Nm	4.5 lb-in
Other Approvals						
	Cat. No.	Std. Pk.		Cat. No.	Std. Pk.	

Terminal Block	CTL2.5U-H	50	CTL2.5U	50	
End Plate	EPCTL2.5U-H	50	EPCTL2.5U	50	
DIN Rail for ordering information refer to pages 90-91					
End Stop for ordering information refer to page 92	CA202 CA702 CA802	50 50 50	CA202 CA702 CA802	50 50 50	
Internal Jumper	2 pole 3 pole 4 pole 10 pole 100 pole	CA722/2 CA722/3 CA722/4 CA722/10 CA722/100	100 50 50 10 5	CA722/2 CA722/3 CA722/4 CA722/10 CA722/100	100 50 50 10 5
Current Bars	2 pole 3 pole 4 pole 10 pole 10 pole (breakable) 100 pole	CA703/1 CA704/1 CA705/1 CA732/10 CA732/10-A CA732/100	100 100 100 100 100 10	CA703/1 CA704/1 CA705/1 CA732/10 CA732/10-A CA732/100	100 100 100 100 100 10
Shorting Sleeve & Screw		CA707/S/Q/01	100	CA707/S/Q/01	100
External Jumper	2 pole 3 pole 4 pole 10 pole	CA715/2 CA715/3 CA715/4 CA715/10	100 100 100 50	CA715/2 CA715/3 CA715/4 CA715/10	100 100 100 50
Marking Tags		MT2	100	MT2	100

COLOR BLOCKS
(other than standard grey)

When ordering please add color suffix to Cat. No.

Example for color Red: **Cat.No./R**

Color	Ordering Suffix	
Red	R	
Yellow	Y	
Blue	BU	
Green	G	
Orange	O	
Beige	BG	
Dark Brown	DB	
Black	BL	
White	W	

Consult Altech for availability.

Feed-Through Triple Level

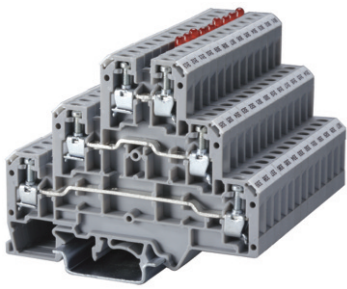

CTL2.5U-H(L)*

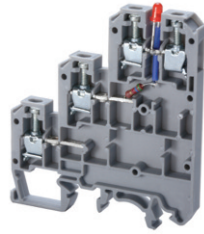

CTL2.5U(L)*

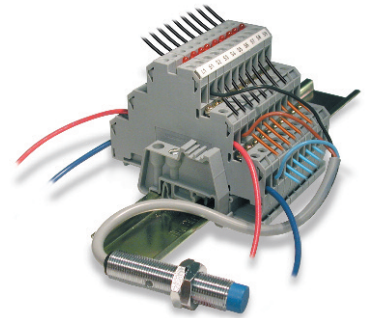

Terminal Width	6 mm			6 mm		
Height x Length	67 x 61 mm			67 x 84 mm		
Stripping Length	9 mm			9 mm		
Insulation Material	Polyamide 6.6			Polyamide 6.6		
Type of Connection	4 Screw clamps & 2 tapped holes for cross connect.			6 Screw clamps & 2 tapped holes for cross connect.		
LED Voltage	12V, 24V, 48V, 110V DC			12V, 24V, 48V, 110V DC		
Approvals						
Wire Range	22-12 AWG	0.2-2.5 sq.mm	22-12 AWG	22-12 AWG	0.2-2.5 sq.mm	22-12 AWG
Voltage Rating	300 V	500 V	300 V	300 V	500 V	300 V
Current Rating	25 A	24 A	25 A	25 A	24 A	25 A
Torque	4.5 lb-in	0.4 Nm	4.5 lb-in	4.5 lb-in	0.4 Nm	4.5 lb-in
Other Approvals						

Ideal for sensor applications.
See Altech's Inductive Proximity Sensor catalog for ordering information.

In applications where switching indication is required, choice of CTL2.5UH(L) and CTL2.5U(L) terminal blocks with built-in electronic components are available.

Terminal Block		Cat. No.	Std. Pk.	Cat. No.	Std. Pk.
Terminal Block		CTL2.5U-H(L)*	50	CTL2.5U(L)*	50
End Plate		EPCTL2.5U-H	50	EPCTL2.5U	50
DIN Rail for ordering information refer to pages 90-91					
End Stop for ordering information refer to page 92		CA202 CA702 CA802	50 50 50	CA202 CA702 CA802	50 50 50
Internal Jumper	2 pole	CA722/2	100	CA722/2	100
	3 pole	CA722/3	50	CA722/3	50
	4 pole	CA722/4	50	CA722/4	50
	10 pole	CA722/10	10	CA722/10	10
	100 pole	CA722/100	5	CA722/100	5
Current Bars	2 pole	CA703/1	100	CA703/1	100
	3 pole	CA704/1	100	CA704/1	100
	4 pole	CA705/1	100	CA705/1	100
	10 pole	CA732/10	100	CA732/10	100
	10 pole (breakable)	CA732/10-A	100	CA732/10-A	100
	100 pole	CA732/100	10	CA732/100	10
Shorting Sleeve & Screw		CA707/S/Q/01	100	CA707/S/Q/01	100
External Jumper	2 pole	CA715/2	100	CA715/2	100
	3 pole	CA715/3	100	CA715/3	100
	4 pole	CA715/4	100	CA715/4	100
	10 pole	CA715/10	50	CA715/10	50
Marking Tags		MT2	100	MT2	100

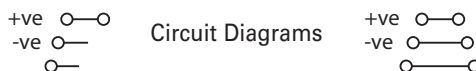

* Add required voltage to part number as suffix; i.e. CTL2.5U(L)/24 for 24V DC

The CDLG2.5 is a double level and the CTLG2.5 is a triple level terminal block with an additional connection point for earthing (Grounding) cables.

This separate connection point is appropriately identified by the green-yellow imprint on its top.

The triple level terminal block is an ideal choice for motor, sensor, actuator and initiator connections.

Double & Triple Level Blocks with Ground

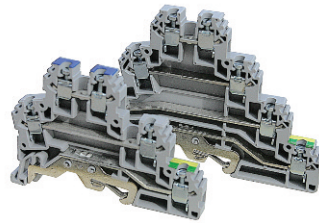

CDLG2.5

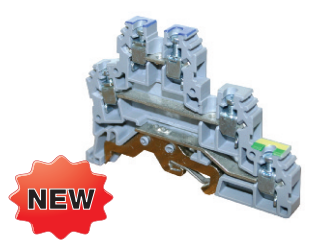

CTLG2.5

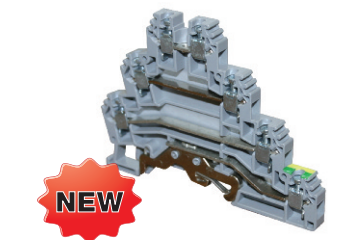

Terminal Width	6 mm			6 mm		
Height x Length	50 x 71 mm			62 x 87.5 mm		
Stripping Length	9 mm			9 mm		
Insulation Material	Polyamide 6.6			Polyamide 6.6		
Type of Connection	5 Screw clamps & 2 tapped holes for cross connect.			7 Screw clamps & 1 tapped hole for cross connect.		
Approvals						
Wire Range	24-12 AWG	0.25-4 mm	24-12 AWG	24-12 AWG	0.25-4 mm	24-12 AWG
Voltage Rating	300 V	500 V	300 V	300 V	440 V	600 V
Current Rating	24 A	24 A	24 A	25 A	24 A	24 A
Torque	4.5 lb-in	0.4 Nm	4.5 lb-in	4.5 lb-in	0.4 Nm	4.5 lb-in

Other Approvals

Cat. No.	Std. Pk.	Cat. No.	Std. Pk.
----------	----------	----------	----------

Terminal Block	CDLG2.5	50	CTLG2.5	50	
End Plate	EPCDLG2.5	50	EPCTLG2.5	50	
DIN Rail for ordering information refer to pages 90-91					
End Stop for ordering information refer to page 92	CA202 CA702 CA802	50 50 50	CA202 CA702 CA802	50 50 50	
Internal Jumper	2 pole 3 pole 4 pole 10 pole	CA627/2 CA627/3 CA627/4 CA627/10	100 50 50 10	CA627/2 CA627/3 CA627/4 CA627/10	100 50 50 10
Insulated Internal Jumper	2 pole 3 pole 4 pole 10 pole	CA647/2 CA647/3 CA647/4 CA647/10	100 50 50 10	CA647/2 CA647/3 CA647/4 CA647/10	100 50 50 10
Current Bars	2 pole 3 pole 4 pole 10 pole 10 pole (breakable) 100 pole	CA703/1 CA704/1 CA705/1 CA732/10 CA732/10-A CA732/100	100 100 100 100 100 10	CA703/1 CA704/1 CA705/1 CA732/10 CA732/10-A CA732/100	100 100 100 100 100 10
Shorting Sleeve & Screw	CA611/S/Q	100	CA611/S/Q	100	
External Jumper	2 pole 3 pole 4 pole 10 pole	CA715/2 CA715/3 CA715/4 CA715/10	100 100 100 50	CA715/2 CA715/3 CA715/4 CA715/10	100 100 100 50
Marking Tags	MT2G	100	MT2G	100	

Ground Blocks

Use ground blocks instead of grounding studs and wire lugs to terminate ground wires, saving installation and wiring time.

They offer:

- High density
- Screw-cage clamp
- Special clamping foot
- Polyamide 6.6
- Color: green/yellow











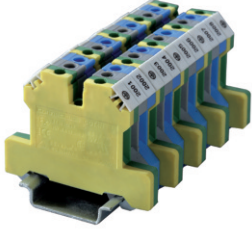
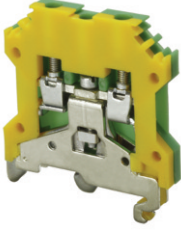











Ground blocks clamp mechanically onto the DIN Rail by tightening the center mounting screw, making a reliable electrical connection between the cage clamp terminals and the DIN Rail. The rail serves as a busbar and automatically distributes ground potential to all other ground terminals on the same rail.

Ground blocks can also be used as end stops, preventing other terminal blocks and components from moving laterally on the DIN Rail.

They are supplied with a standard green/yellow housing for easy identification and accept standard marking tags.

CGT4U and CGT35U can be mounted on both DIN 32mm and DIN 35mm rails.

CGT4N, CGT6N, CGT10N and CGT16N can be mounted on 35mm DIN rail and have the same top outer profile as the feed through blocks (CTS4U-N, CTS2.5U-N, CTS6U, CTS10U and CTS16U).

	CGT4U			CGT4N		
						
Terminal Width	6 mm			6 mm		
Height x Length	48 x 43 mm			45.4 x 54.2 mm		
Stripping Length	8 mm			8 mm		
Insulation Material	Polyamide 6.6			Polyamide 6.6		
Type of Connection	2 screw clamps			2 screw clamps		
Approvals	  			  		
Wire Range	22-10 AWG	0.2-4 sq.mm	22-10 AWG	22-10 AWG	0.2-4 sq.mm	22-10 AWG
Torque	7 lb-in	0.5 Nm	7 lb-in	7 lb-in	0.5 Nm	7 lb-in
Other Approvals	     			    		
	Cat. No.	Std. Pk.		Cat. No.	Std. Pk.	
Terminal Block	CGT4U	50		CGT4N	50	
DIN Rail for ordering information refer to pages 90-91						
End Plate 	EPCGT4U	50				
Marking Tags (MT Type) 	MT6	100		MT6	100	

CGT6N			CGT10N			CGT16N			CGT35U								
																	
8 mm			10 mm			12 mm			16 mm								
47 x 54.5 mm			50 x 45 mm			47 x 43 mm			61.5 x 58 mm								
9 mm			11 mm			12 mm			15 mm								
Polyamide 6.6			Polyamide 6.6			Polyamide 6.6			Polyamide 6.6								
2 screw clamps			2 screw clamps			2 screw clamps			2 screw clamps								
																	
C 22-8 AWG	60947-7-2 0.2-6 sq.mm	C 22-8 AWG E220514	C 0.2-10 sq.mm	C 16-6 AWG E220514	C 0.2-16 sq.mm	C 20-4 AWG E220514	C 8-2 AWG	60947-7-2 2.5-35 sq.mm	C 8-2 AWG	C 8-2 AWG	C 8-2 AWG						
14 lb-in	0.8 Nm	14 lb-in	1.2 Nm	14 lb-in	1.2 Nm	14 lb-in	25 lb-in	2.5 Nm	25 lb-in	25 lb-in	25 lb-in						
																	
Cat. No.	Std. Pk.		Cat. No.	Std. Pk.		Cat. No.	Std. Pk.		Cat. No.	Std. Pk.		Cat. No.	Std. Pk.		Cat. No.	Std. Pk.	
CGT6N	50		CGT10N	50		CGT16N	50		CGT35U	20							
																	
MT8	100		MT10	100		MT12	100		MT15	100							

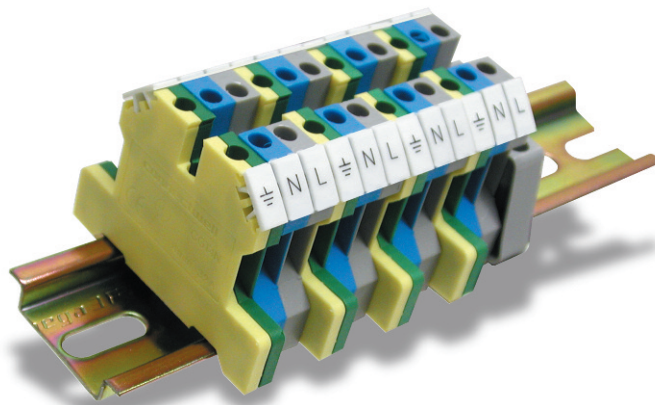

*Assembly for single phase
3 wire circuits.*

Fuse Blocks, 5 x 20 and 5 x 25 mm

Altech fuse terminals are also available with light indication - CF4U(L). A specially designed built-in circuit gives light indication in the event of fuse blow out. Thus, fault in a circuit can be easily located. No polarity is required.

Important:

The disconnecting device is not suitable for interrupting load. The supply must be switched off before operating the slide link/lever.

† Fuses are sold separately see pages 100-101.

* Add required voltage to part number as a suffix. i.e. CF4U(L)/6-60 for 6-60 V AC/DC.

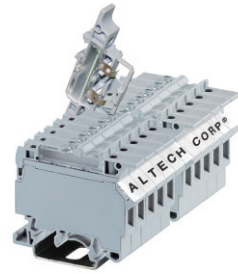

Terminal Width	8 mm
Height x Length	57.6 x 57 mm
Stripping Length	9.5 mm
Insulation Material	Polyamide 6.6
Type of Connection	4 screw clamps
LED Voltage	6-60 V AC/DC 90-240 V AC/DC
Type of Fuse Used	Ø5x20, Ø5x25 mm
Approvals	SP US, IEC 60947-7-3, UL E220514
Wire Range	22-10 AWG, 0.2-4 mm ²
Voltage Rating	600 V, 1000 V, 600 V
Current Rating	10 A, 6.3 A, 10 A
Torque	7 lb-in, 0.5 Nm, 7 lb-in
Other Approvals	RoHS, CE

Terminal Block

DIN Rail for ordering information refer to pages 90-91

End Stop for ordering information refer to page 92

Internal Jumper
2 pole
3 pole
4 pole
10 pole

Insulated Internal Jumper
2 pole
3 pole
4 pole
10 pole

Current Bar
2 pole
3 pole
4 pole
10 pole

Shorting Sleeve & Screw

External Jumper
2 pole
3 pole
4 pole
10 pole

Marking Tags (on terminal) (on Lever)

COLOR BLOCKS	
(other than standard grey)	
When ordering please add color suffix to Cat. No.	
Example for color Red: Cat.No./R	
Color	Ordering Suffix
Red	R
Yellow	Y
Blue	BU
Green	G
Consult Altech for availability:	
Orange	O
Beige	BG
Dark Brown	DB
Black	BL
White	W

CF4U†

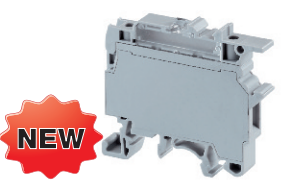

Terminal Width	8 mm
Height x Length	57.6 x 57 mm
Stripping Length	9.5 mm
Insulation Material	Polyamide 6.6
Type of Connection	4 screw clamps
Type of Fuse Used	Ø5x20, Ø5x25 mm
Approvals	SP US, IEC 60947-7-3, UL E220514
Wire Range	22-10 AWG, 0.2-4 mm ²
Voltage Rating	600 V, 1000 V, 600 V
Current Rating	10 A, 6.3 A, 10 A
Torque	7 lb-in, 0.5 Nm, 7 lb-in
Other Approvals	RoHS, CE



Cat. No.	Std. Pk.
CF4U	100

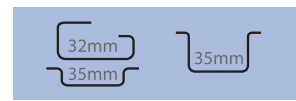

CA702	50
CA802	50

CA711/2	100
CA711/3	50
CA711/4	50
CA711/10	20

MT8	100
MT8	100

CF4U(L)†*

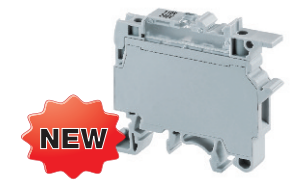

No Polarity Required.

Terminal Width	8 mm
Height x Length	57.6 x 57 mm
Stripping Length	9.5 mm
Insulation Material	Polyamide 6.6
Type of Connection	4 screw clamps
Type of Fuse Used	Ø5x20, Ø5x25 mm
Approvals	SP US, IEC 60947-7-3, UL E220514
Wire Range	22-10 AWG, 0.2-4 mm ²
Voltage Rating	600 V, 600 V, 600 V
Current Rating	10 A, 6.3 A, 10 A
Torque	7 lb-in, 0.5 Nm, 7 lb-in
Other Approvals	RoHS, CE



Cat. No.	Std. Pk.
CF4U(L)*	50

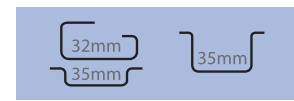

CA702	50
CA802	50

CA711/2	100
CA711/3	50
CA711/4	50
CA711/10	20

MT8	100
MT8	100

CF4U(L) Only

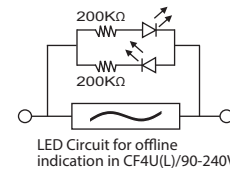
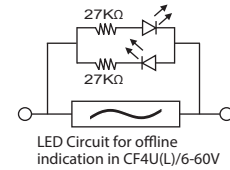

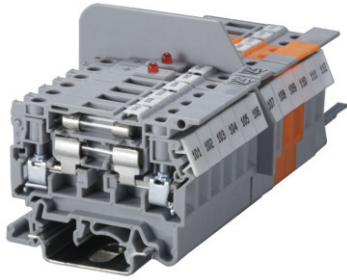

DDFL4U - Double Level Fuse Terminal with fuse link on the top level has a separate feed through terminal at the lower level. This eliminates use of an additional feed through terminal.

In DDFL4U(E), specially designed built in circuit gives light indication in the event of a fuse blow out at the top level. The terminal provides separate feed through connection possibility at the lower level.

Important:

The disconnecting device is not suitable for interrupting load. The supply must be switched off before operating the slide link/lever.

† Fuses are sold separately Altech, see pages 100-101.

* Add required voltage to part number as suffix, i.e. DDFL4U(E)/24 for 24V AC/DC

COLOR BLOCKS
(other than standard grey)

When ordering please add color suffix to Cat. No.

Example for color Red: **Cat.No./R**

Color	Ordering Suffix
Red	R
Yellow	Y
Blue	BU
Green	G
Orange	O
Beige	BG
Dark Brown	DB
Black	BL
White	W

Consult Altech for availability.

Terminal Width	8 mm
Height x Length	66 x 88 mm
Stripping Length	9.5 mm
Insulation Material	Polyamide 6.6
Type of Connection	4 screw clamps & 1 tapped hole for cross connection
LED Voltage	24V AC/DC, 48V AC/DC, 110V AC/DC, 220V AC/DC, 440V AC
Type of Fuse Used	Ø5x20, Ø5x25 mm
Approvals	
Wire Range	22-10 AWG 0.2-4 mm ² 22-10 AWG
Voltage Rating	600 V 800 V 600 V
Current Rating	Top Level 6.3 A 35 A 6.3 A 32 A 6.3 A 35 A
Torque	7 lb-in 0.5 N 7 lb-in
Other Approvals	

Terminal Block	
End Plate	
DIN Rail for ordering information refer to pages 90-91	
End Stop for ordering information refer to page 92	
Internal Jumper	2 pole 3 pole 4 pole 10 pole
Insulated Internal Jumper	2 pole 3 pole 4 pole 10 pole
Current Bar	2 pole 3 pole 4 pole 10 pole
Shorting Sleeve & Screw	
External Jumper	2 pole 3 pole 4 pole 10 pole
Marking Tags (on terminal) (on lever)	

Fuse Blocks, 5 x 20 and 5 x 25 mm

DDFL4U

DDFL4U(E)*

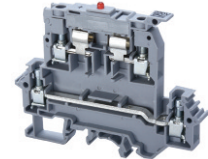
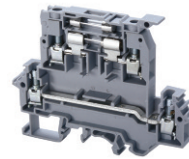

† Fuse not included.

† Fuse not included.

Terminal Width	8 mm
Height x Length	66 x 88 mm
Stripping Length	9.5 mm
Insulation Material	Polyamide 6.6
Type of Connection	4 screw clamps & 1 tapped hole for cross connection
Type of Fuse Used	Ø5x20, Ø5x25 mm
Approvals	
Wire Range	22-10 AWG 0.2-4 mm ² 22-10 AWG
Voltage Rating	600 V 800 V 600 V
Current Rating	6.3 A 35 A 6.3 A 32 A 6.3 A 35 A
Torque	7 lb-in 0.5 N 7 lb-in
Other Approvals	

Terminal Width	8 mm
Height x Length	66 x 88 mm
Stripping Length	9.5 mm
Insulation Material	Polyamide 6.6
Type of Connection	4 screw clamps & 1 tapped hole for cross connection
Type of Fuse Used	Ø5x20, Ø5x25 mm
Approvals	
Wire Range	22-10 AWG 0.2-4 mm ² 22-10 AWG
Voltage Rating	600 V 800 V 600 V
Current Rating	6.3 A 35 A 6.3 A 32 A 6.3 A 35 A
Torque	7 lb-in 0.5 Nm 7 lb-in
Other Approvals	

Cat. No.	Std. Pk.
DDFL4U	20
EPDDFL4U	20
CA702	50
CA802	50
CA202	50
CA729/2	100
CA729/3	50
CA729/4	50
CA729/10	10
CA749/2	100
CA749/3	50
CA749/4	50
CA749/10	10
CA703/6	100
CA704/6	100
CA705/6	100
CA737/10	100
CA707/S/Q/3	100
CA711/2	100
CA711/3	100
CA711/4	50
CA711/10	25
MT8	100
MT2	100

Cat. No.	Std. Pk.
DDFL4U(E)*	20
EPDDFL4U	20
CA702	50
CA802	50
CA202	50
CA729/2	100
CA729/3	50
CA729/4	50
CA729/10	10
CA749/2	100
CA749/3	50
CA749/4	50
CA749/10	10
CA703/6	100
CA704/6	100
CA705/6	100
CA737/10	100
CA707/S/Q/3	100
CA711/2	100
CA711/3	100
CA711/4	50
CA711/10	25
MT8	100
MT2	100

Fuse Blocks, 5 x 20 and 5 x 25 mm

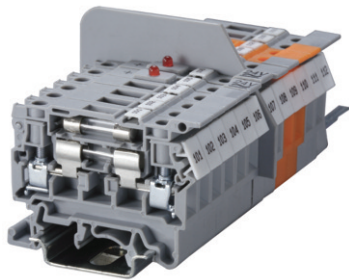

DDFL4ULR is a modified version of the DDFL4U terminal where two equipotential connection points are available on both ends of the terminal.

DDFL4U(E)LR* is similar to the DDFL4ULR, but has a built in circuit that gives light indication in the event of a blown fuse.

Important:

The disconnecting device is not suitable for interrupting load. The supply must be switched off before operating the slide link/lever.

† Fuses are sold separately Altech, see pages 100-101.

* Add required voltage to part number as suffix, i.e. DDFL4U(E)LR/24 for 24V AC/DC

COLOR BLOCKS
(other than standard grey)

When ordering please add color suffix to Cat. No.

Example for color Red: **Cat.No./R**

Color	Ordering Suffix
Red	R
Yellow	Y
Blue	BU
Green	G
Orange	O
Beige	BG
Dark Brown	DB
Black	BL
White	W

Consult Altech for availability.

Terminal Width	8 mm
Height x Length	66 x 88 mm
Stripping Length	9.5 mm
Insulation Material	Polyamide 6.6
Type of Connection	4 screw clamps & 1 tapped hole for cross connection
LED Voltage	
Type of Fuse Used	Ø5x20, Ø5x25 mm
Approvals	
Wire Range	22-10 AWG
Voltage Rating	600 V
Current Rating	Top Level
Torque	7 lb-in

Other Approvals

Terminal Block

End Plate	
DIN Rail for ordering information refer to pages 90-91	
End Stop for ordering information refer to page 92	
Internal Jumper	2 pole 3 pole 4 pole 10 pole
Insulated Internal Jumper	2 pole 3 pole 4 pole 10 pole
Current Bar	2 pole 3 pole 4 pole 10 pole
Shorting Sleeve & Screw	
External Jumper	2 pole 3 pole 4 pole 10 pole
Marking Tags (on terminal) (on lever)	

DDFL4ULR

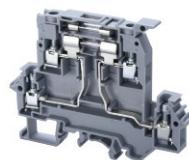

† Fuse not included.

Terminal Width	8 mm
Height x Length	66 x 88 mm
Stripping Length	9.5 mm
Insulation Material	Polyamide 6.6
Type of Connection	4 screw clamps & 1 tapped hole for cross connection
LED Voltage	
Type of Fuse Used	Ø5x20, Ø5x25 mm
Approvals	
Wire Range	22-10 AWG
Voltage Rating	600 V
Current Rating	6.3 A
Torque	7 lb-in



Cat. No.	Std. Pk.
DDFL4ULR	20
EPDDFL4U	20
CA702	50
CA802	50
CA202	50
CA730/2	100
CA730/3	50
CA730/4	50
CA730/10	10
CA740/2	100
CA740/3	50
CA740/4	50
CA740/10	10
CA703/7	100
CA704/7	100
CA705/7	100
CA738/10	100
CA707/S/Q/8	100
CA711/2	100
CA711/3	100
CA711/4	50
CA711/10	25
MT8	100
MT2	100

DDFL4U(E)LR*

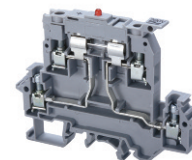

† Fuse not included.

Terminal Width	8 mm
Height x Length	66 x 88 mm
Stripping Length	9.5 mm
Insulation Material	Polyamide 6.6
Type of Connection	4 screw clamps & 1 tapped hole for cross connection
LED Voltage	24V AC/DC, 48V AC/DC, 110V AC/DC, 220V AC
Type of Fuse Used	Ø5x20, Ø5x25 mm
Approvals	
Wire Range	22-10 AWG
Voltage Rating	600 V
Current Rating	6.3 A
Torque	7 lb-in



Cat. No.	Std. Pk.
DDFL4U(E)LR*	20
EPDDFL4U	20
CA702	50
CA802	50
CA202	50
CA730/2	100
CA730/3	50
CA730/4	50
CA730/10	10
CA740/2	100
CA740/3	50
CA740/4	50
CA740/10	10
CA703/7	100
CA704/7	100
CA705/7	100
CA738/10	100
CA707/S/Q/8	100
CA711/2	100
CA711/3	100
CA711/4	50
CA711/10	25
MT8	100
MT2	100

CAFL4U(L) is equipped with a LED for blown fuse indication. CAFL4U(N) is equipped with a neon bulb for same application.

CAFL4U

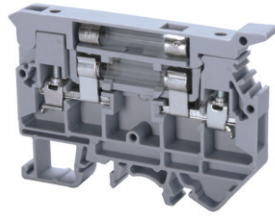

† Fuse not included.

CAFL4U(L)*

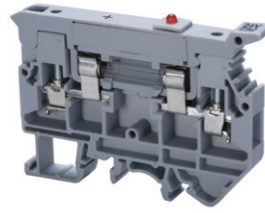

† Fuse not included.

CAFL4U(N)

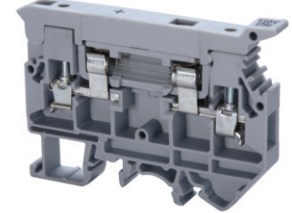

† Fuse not included.

Terminal Width	9 mm			9 mm			9 mm		
Height x Length	50 x 72 mm			50 x 72 mm			50 x 72 mm		
Stripping Length	9.5 mm			9.5 mm			9.5 mm		
Insulation Material	Polyamide 6.6			Polyamide 6.6			Polyamide 6.6		
Type of Connection	2 screw clamps			2 screw clamps			2 screw clamps		
LED/Neon Voltage				24V AC/DC, 48V AC/DC, 110V AC/DC, 220V AC, 300V AC			110-220V AC/DC, 300V AC		
Type of Fuse Used	Ø1/4x1 in., Ø1/4x1 1/4 in.			Ø1/4x1 in., Ø1/4x1 1/4 in.			Ø1/4x1 in., Ø1/4x1 1/4 in.		
Approvals									
Wire Range	22-10 AWG	0.2-4 sq.mm	22-10 AWG	22-10 AWG	0.2-4 sq.mm	22-10 AWG	22-10 AWG	0.2-4 sq.mm	22-10 AWG
Voltage Rating	600 V	1000 V	600 V	600 V	1000 V	600 V	600 V	1000 V	600 V
Current Rating	16 A	6.3 A	16 A	16 A	6.3 A	16 A	16 A	6.3 A	16 A
Torque	7 lb-in	0.5 Nm	7 lb-in	7 lb-in	0.5 Nm	7 lb-in	7 lb-in	0.5 Nm	7 lb-in
Other Approvals									

		Cat. No.	Std. Pk.		Cat. No.	Std. Pk.		Cat. No.	Std. Pk.
Terminal Block		CAFL4U	25		CAFL4U(L)*	25		CAFL4U(N)	25
End Plate		EPCAFL4U	50		EPCAFL4U	50		EPCAFL4U	50
DIN Rail for ordering information refer to pages 90-91									
End Stop for ordering information refer to page 92		CA702 CA802	50 50		CA702 CA802	50 50		CA702 CA802	50 50
External Jumper	2 pole 3 pole 4 pole 10 pole	CA716/2 CA716/3 CA716/4 CA716/10	50 50 50 25		CA716/2 CA716/3 CA716/4 CA716/10	100 50 50 20		CA716/2 CA716/3 CA716/4 CA716/10	100 50 50 20
Marking Tags		MT9	100		MT9	100		MT9	100

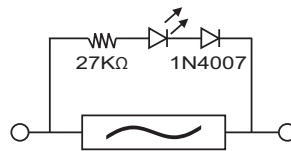

LED Circuit for offline indication in CAFL4UL24V

Fuse Holders, 10 x 38 mm and CC Type

The main characteristics of fuse disconnectors are:

- UL recognized (10x38mm)
- UL listed (CC Type)
- Compliance with IEC 60947-1, IEC 60947-3
- Plastic parts are made of material resistant to high temperatures
- All contact surfaces are silver plated
- Mounting on standard DIN 35 mm rail (DIN EN60715).
- Available up to 4 pole
- For all sizes a version with electronic indicator is available. There are two technical types of indicator:

L (LED) (10x38mm only) with built in LED diode which blinks after the fuse-link operates. The internal circuit resistance is 2M, thus the total dissipation is minimal. The indicator is capable of operating in conditions of open circuit with minimum capacitance between connection cables. Operating voltage range spans from 50V to 690V AC and DC.

I (NEON) (10x38mm only) with neon lamp, which is constantly lit after the fuse-link operates. The internal circuit resistance is 570k, thus it is necessary that the circuit be closed in order for the indicator to function. The operational voltage range is 100 V to 750 V AC.

* Fuses are sold separately Altech, see pages 100-101.

**1000V UL PV rating pending.

	1 POLE	2 POLE	3 POLE
--	--------	--------	--------



Terminal Width (B)	17.5 mm	35 mm	52.5 mm
Height x Length	81 x 64.5 mm	81 x 64.5 mm	81 x 64.5 mm
Stripping Length	11 mm	11 mm	11 mm
Insulation Material	Aculon®	Aculon®	Aculon®
Type of Connection	2 screw clamps	2 screw clamps	2 screw clamps
Wire Range	1.5-25sq.mm / 24-4 AWG	1.5-25sq.mm / 24-4 AWG	1.5-25sq.mm / 24-4 AWG
IEC Rating	690 V / 32A	690 V / 32A	690 V / 32A
cUL _{us} Rating	600 V AC/DC / 30A	600 V AC/DC / 30A	600 V AC/DC / 30A
Torque	2-2.5 Nm / 31 lb-in	2-2.5 Nm / 31 lb-in	2-2.5 Nm / 31 lb-in

Cylindrical 10x38

Indicator:	Cat. No.	Std. Pk.	Cat. No.	Std. Pk.	Cat. No.	Std. Pk.
None	CB1038-1	1	CB1038-2	1	CB1038-3	1
LED	CB1038-1/L	1	CB1038-2/L	1	CB1038-3/L	1
Neon	CB1038-1/I	1	CB1038-2/I	1	CB1038-3/I	1

Type of Fuse Used	Ø10 x 38 mm		Ø10 x 38 mm		Ø10 x 38 mm	
Approvals**						

CC Type Holder

Cat. No.	Std. Pk.	Cat. No.	Std. Pk.	Cat. No.	Std. Pk.
CB10CC-1	1	CB10CC-2	1	CB10CC-3	1

Type of Fuse Used	CC Type		CC Type		CC Type	
Approvals						

DIN Rail	35mm		35mm		35mm	
for ordering information refer to pages 90-91						

End Stop	CA702	50	CA702	50	CA702	50
for ordering information refer to page 92	CA802	50	CA802	50	CA802	50

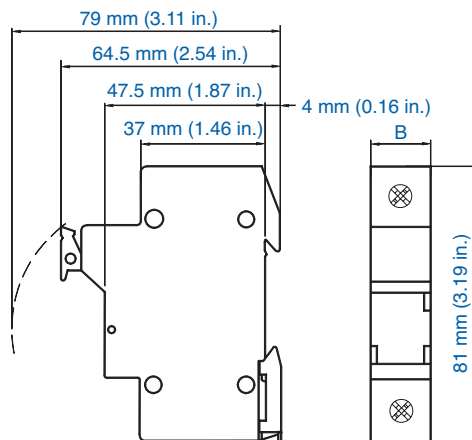
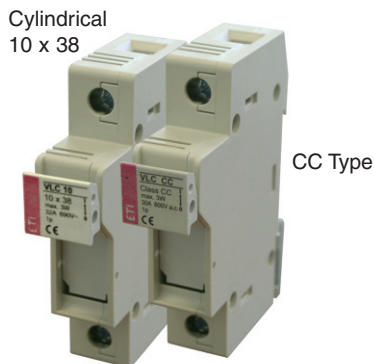

Dimension for B:	
1 Pole	17.5mm
1 Pole + Neutral	35mm
2 Pole	35mm
3 Pole	52.5mm
3 Pole + Neutral	70mm

With Altech's large line of UL Circuit Protection Devices you get the right product for your application.

POWER CIRCUIT

CONTROL CIRCUIT

POWER CIRCUIT

- V-EA Series - UL508 Listed Manual Motor Controllers "Suitable as Motor Disconnect"
- UL(AC), DL(DC) Series - UL489 Miniature Molded Case Circuit Breakers
- L Series - AC or DC Miniature Molded Case Circuit Breakers
- UR Series - UL1077 Recognized Supplementary Protector
- R Series - UL1077 Recognized Supplementary Protector
- UL489 Busbar Systems
- UL508 and UL1077 Busbar Systems
- MA Series - Three Phase Adjustable Trip Miniature Circuit Breakers/ Manual Motor Controllers
- MS Series - Three Phase Adjustable Trip Economy
- Manual Motor Controllers
- RP Series - RCCB Earth Leakage Circuit Breakers
- TR11, TR20 and TR30 Series - UL1077 Recognized Supplementary Protector/ Circuit Breaker for Equipment
- TD / TS Series - UL489 Listed Molded Case Circuit Breakers



















Visit altechcorp.com/breakers

Disconnect

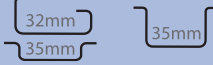
Disconnect and test terminals are an ideal choice for measuring control and regulatory circuits. The terminals provide a clear functional advantage for devices having utility instruments and associated transformers.

- CSDL4U - hinged disconnection and testing terminal, incorporates a connecting link in place of the fuse link.
- DDDL4U - double level disconnect terminal with hinged disconnect in upper level.

Important: The disconnecting device is not suitable for interrupting load. The supply must be switched off before operating the slide link/lever.

	CSDL4U			DDDL4U		
Terminal Width	8 mm			8 mm		
Height x Length	43 x 58 mm			66 x 88 mm		
Stripping Length	9.5 mm			9.5 mm		
Insulation Material	Polyamide 6.6			Polyamide 6.6		
Type of Connection	2 screw clamps			4 screw clamps & 1 tapped hole for cross connection		
Approvals						
Wire Range	22-10 AWG	0.2-4 sq.mm	22-10 AWG	22-10 AWG	0.2-4 sq.mm	22-10 AWG
Voltage Rating	600 V	1000 V	600 V	600 V	800 V	600 V
Current Rating	14 A	10 A	14 A	14 / 35 A	10 A	6.3 / 35 A
Torque	7 lb-in	0.5 Nm	7 lb-in	7 lb-in	0.5 Nm	7 lb-in
Other Approvals						
	Cat. No.	Std. Pk.		Cat. No.	Std. Pk.	
Terminal Block	CSDL4U	100		DDDL4U	20	
End Plate 	EPCSFL4U	50		EPDDL4U	20	
Isolation Partition 	PPCSFL4U	50				
DIN Rail for ordering information refer to pages 90-91						
End Stop for ordering information refer to page 92 	CA702 CA802	50 50		CA702 CA802	50 50	
Internal Jumper 	2 pole 3 pole 4 pole 10 pole			CA729/2 CA729/3 CA729/4 CA729/10	100 50 50 10	
Insulated Internal Jumper 	2 pole 3 pole 4 pole 10 pole			CA749/2 CA749/3 CA749/4 CA749/10	100 50 50 10	
Current Bar 	2 pole 3 pole 4 pole 10 pole			CA703/6 CA704/6 CA705/6 CA737/10	100 100 100 100	
Shorting Sleeve & Screw				CA707/S/Q/3	100	
External Jumper 	2 pole 3 pole 4 pole 10 pole	CA711/2 CA711/3 CA711/4 CA711/10	100 100 50 25	CA711/2 CA711/3 CA711/4 CA711/10	100 100 50 25	
Marking Tags (on terminal) 	(on lever)	MT8 MT2	100 100	MT8 MT2	100 100	

Disconnect and test terminals are an ideal choice for measuring control and regulatory circuits. The terminals provide a clear functional advantage for devices having utility instruments and associated transformers.

CKT4U and CKT4U/4 - disconnection is achieved by lifting the knife contact lever.

CKT4U/4 Terminal has standard screws on the upper level clamps and socket screws on the lower level clamps.

Specially designed socket head screws act as test/monitoring points in the CKT4U.

Important: The disconnecting device is not suitable for interrupting load. The supply must be switched off before operating the slide link/lever.

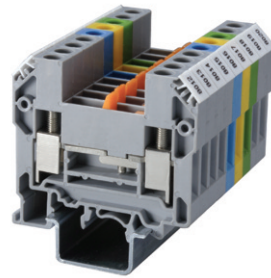

Disconnect and Test Terminal Blocks

CKT4U	CKT4U/4
-------	---------

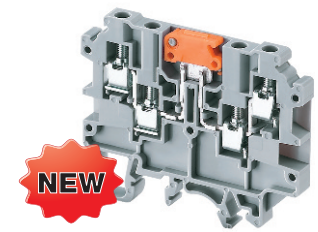
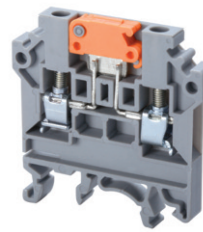

Terminal Width	6 mm			6 mm		
Height x Length	46 x 46.3 mm			46 x 46.3 mm		
Stripping Length	9 mm			9 mm		
Insulation Material	Polyamide 6.6			Polyamide 6.6		
Type of Connection	2 screw clamps			2 screw clamps		
Approvals						
Wire Range	22-10 AWG	0.2-4 sq.mm	22-10 AWG	22-10 AWG	0.2-4 sq.mm	22-10 AWG
Voltage Rating	600 V	800 V	600 V	600 V	800 V	600 V
Current Rating	16 A	28 A	30 A	20 A	20 A	20 A
Torque	7 lb-in	0.5 Nm	7 lb-in	7 lb-in	0.5 Nm	7 lb-in
Other Approvals						
Terminal Block	CKT4U	50	CKT4U/4	50		
End Plate	EPCKT4U	50	EPCKT4U/4	50		
DIN Rail for ordering information refer to pages 90-91						
End Stop for ordering information refer to page 92	CA702	50	CA702	50		
	CA802	50	CA802	50		
External Jumper	2 pole	100	CA714/2*	100		
	3 pole	100	CA714/3*	100		
	4 pole	50	CA714/4*	50		
	10 pole	25	CA714/10*	25		
Marking Tags	MT6	100	MT6	100		

* Insulated External shorting links can be used only in the upper level clamping unit of the Terminal Block.

Disconnect and Test Terminal Blocks

Disconnect and test terminals are an ideal choice for measuring control and regulatory circuits. The terminals provide a clear functional advantage for devices having utility instruments and associated transformers when it is mandatory to keep the secondary side shorted at any point while taking current measurements. Specially designed socket head screws act as test/monitoring points.

CDTTU + CDTTU-SH - disconnection is achieved by means of a slide link operated with a screw driver.

In the CDS6U separate testing points facilitate insertion of test probes. Disconnection is achieved by means of a slide link operated with a Screw Driver.

In the CDS6U/TS, the insulated test point screw system (TPSLS) is integrated.

CDS6U/FT Terminal Block is a standard feed through Terminal Block.











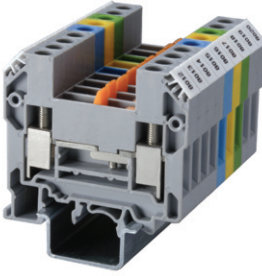
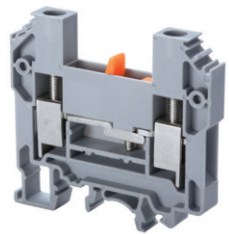
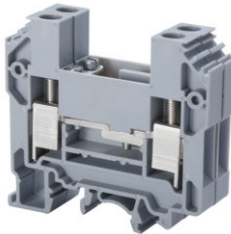









In the CDS6U/SC Disconnect & Test Terminal Block, an additional safety spring is provided underneath the screw clamp. These Terminal Blocks are preferred for connections that involve safety requirements of the Electric Supply Industry (ESI) standards, British CEEB regulations and NTPC applications.











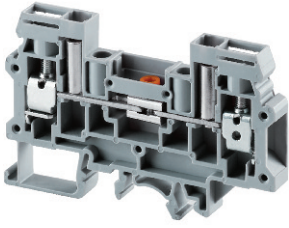
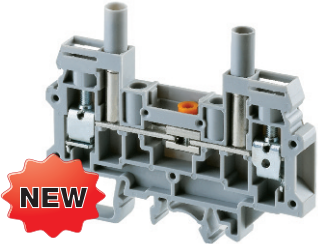
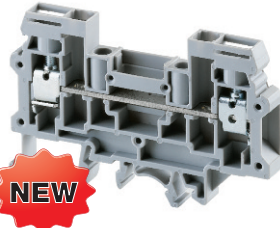
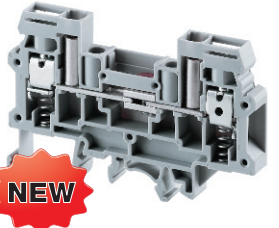

















The SLS2 and SLS4 slide shorting link can be used in combination with either the supplied screw or the TPSLS Test point screw system.

Lock out cap LCCDS can be used to lock the center shorting screw, to prevent accidental opening of circuits.

Specially designed socket head screws act as test/monitoring points in CDTTU and CDTTU-SH.

Important: The disconnecting device is not suitable for interrupting load. The supply must be switched off before operating the slide link/lever.

		CDTTU			CDTTU-SH		
							
Terminal Width		8 mm			16 mm		
Height x Length		57 x 63 mm			57 x 63 mm		
Stripping Length		12 mm			12 mm		
Insulation Material		Polyamide 6.6			Polyamide 6.6		
Type of Connection		2 screw clamps			4 screw clamps		
Approvals							
Wire Range		16-8 AWG	1.5-6 sq.mm	16-8 AWG	16-8 AWG	1.5-6 sq.mm	16-8 AWG
Voltage Rating		600 V	800 V	600 V	300 V	160 V	300 V
Current Rating		41 A	41 A	41 A	25 A	10 A	25 A
Torque		14 lb-in	1.2 Nm	14 lb-in	14 lb-in	1.2 Nm	14 lb-in
Other Approvals							
Terminal Block		CDTTU	50	CDTTU-SH	50		
End Plate 		EPCDTTU	50	EPCDTTU	50		
DIN Rail for ordering information refer to pages 90-91							
End Stop for ordering information refer to page 92 		CA702 CA802	50 50	CA702 CA802	50 50		
Internal Jumper	2 pole 3 pole 4 pole 5 pole 10 pole 						
Slide Shorting Link	2 pole 4 pole 						
Insulated Test Socket	Gray Red Yellow Blue Black 						
Switchable Link Assembly 							
Lock Out Cap							
External Jumper	2 pole 3 pole 4 pole 10 pole 	CA710/2 CA710/3 CA710/4 CA710/10	100 50 50 20	CA710/2 CA710/3 CA710/4 CA710/10	100 50 50 20		
Marking Tags 		MT8	100	MT8	100		

CDS6U			CDS6U/TS			CDS6U/FT			CDS6U/SC		
											
8 mm			8 mm			6 mm			6 mm		
50 x 82 mm			50 x 82 mm			50 x 82 mm			50 x 82 mm		
10 mm			10 mm			10 mm			10 mm		
Polyamide 6.6			Polyamide 6.6			Polyamide 6.6			Polyamide 6.6		
2 screw clamps			2 screw clamps			2 screw clamps			2 screw clamps		
											
22-8 AWG	0.2-6 sq.mm	22-8 AWG	22-8 AWG	0.2-6 sq.mm	22-8 AWG	22-8 AWG	0.2-6 sq.mm	22-8 AWG	22-8 AWG	0.2-6 sq.mm	22-8 AWG
600 V	800 V	600 V	600 V	630 V	600 V	600 V	1000 V	600 V	600 V	800 V	600 V
45 A	41 A	45 A	45 A	41 A	45 A	45 A	41 A	45 A	45 A	41 A	45 A
14 lb-in	0.8 Nm	14 lb-in	14 lb-in	0.8 Nm	14 lb-in	14 lb-in	0.8 Nm	14 lb-in	14 lb-in	0.8 Nm	14 lb-in
											
Cat. No.	Std. Pk.		Cat. No.	Std. Pk.		Cat. No.	Std. Pk.		Cat. No.	Std. Pk.	
CDS6U	50		CDS6U/TS	50		CDS6U/FT	50		CDS6U/SC	50	
EPCDS6U	50		EPCDS6U	50		EPCDS6U	50		EPCDS6U	50	
											
CA702	50		CA702	50		CA702	50		CA702	50	
CA802	50		CA802	5		CA802	5		CA802	5	
CA723/2	100		CA723/2	100		CA723/2	100		CA723/2	100	
CA723/3	50		CA723/3	50		CA723/3	50		CA723/3	50	
CA723/4	50		CA723/4	50		CA723/4	50		CA723/4	50	
CA723/5	50		CA723/5	50		CA723/5	50		CA723/5	50	
CA723/10	10		CA723/10	10		CA723/10	10		CA723/10	10	
SLS2	50		SLS2	50					SLS2	50	
SLS4	25		SLS4	25					SLS4	25	
TPSLS	100		TPSLS	100					TPSLS	100	
TPSLSR	100		TPSLSR	100					TPSLSR	100	
TPSLSY	100		TPSLSY	100					TPSLSY	100	
TPSLSBU	100		TPSLSBU	100					TPSLSBU	100	
TPSLSBK	100		TPSLSBK	100					TPSLSBK	100	
SWCDS	50		SWCDS	50		SWCDS	50		SWCDS	50	
LCCDS	50		LCCDS	50		LCCDS	50		LCCDS	50	
MT8	100		MT8	100		MT8	100		MT8	100	

Usage of CDS6U range of products in Simple Current Transformer Test Circuit

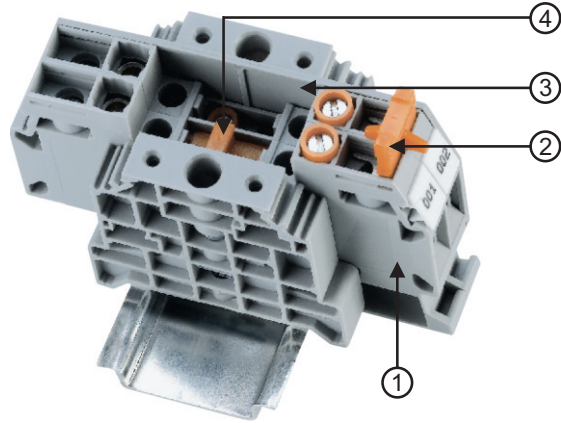

No.	Cat. No.	Qty.
1	CDS6U	2
2	SLS2	1
3	EPCDS6U	1
4	LCCDS	1

Operating status

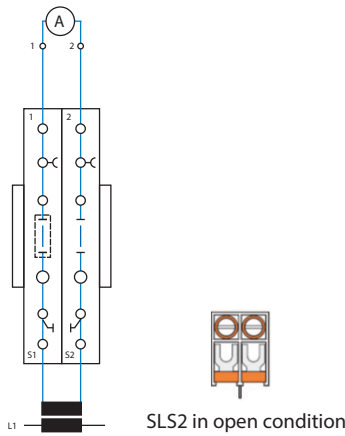

Meter test for L1 through external power supply

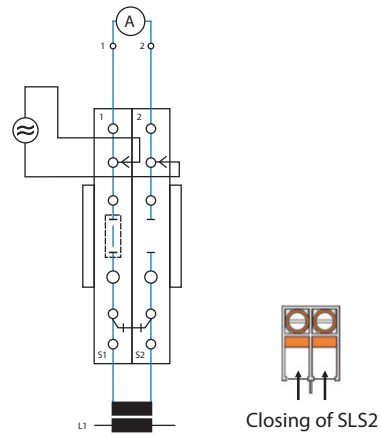

Sequence for test :

- 1) Close short circuit slide SLS2 of terminals 1 and 2.
- 2) Open disconnect slide link of terminal 2.
- 3) Connect external power supply to test sockets of terminals 1 and 2.

Comparison measurement for L1

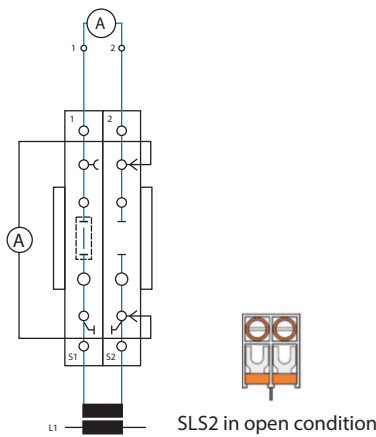

Sequence for test :

- 1) Remove SLS2 screw from terminal 2.
- 2) Connect ammeter to test sockets of terminal 2.
- 3) Open disconnect slide link of terminal 2.

Changing the meter for L1

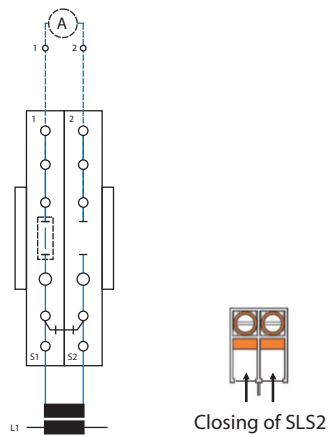

Sequence for test :

- 1) Close short circuit slide SLS2 of terminals 1 and 2.
- 2) Open disconnect slide link of terminal 2.
- 3) Disconnect meter for L1 at terminals 1 and 2.

Usage of CDS6U range of products in 3 Phase Current Transformer Test Set ①
 Usage of CDS6U range of products 3 Phase Linked Current Transformer Test Set ②

No.	Cat. No.	Qty.
1	CDS6U	6
2	SLS2	3
3	LCCDS	3
4	CA723/5	1
5	EPCDS6U	1

No.	Cat. No.	Qty.
1	CDS6U	6
2	SLS4	1
3	LCCDS	3
4	CA723/3	1
5	EPCDS6U	1

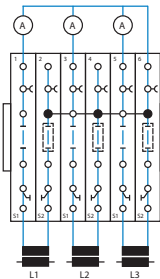

Operating status
(with internal distribution
of the k-point)



SLS2 in open condition

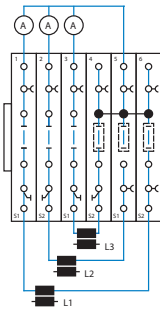

Operating status

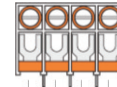

SLS4 in open condition

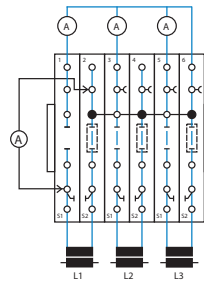

Comparison measurement for L1

Sequence for test :

- 1) Remove SLS2 screw from terminal 1.
- 2) Connect ammeter to test sockets of terminal 1 and 2.
- 3) Open disconnect slide link of terminal 1.

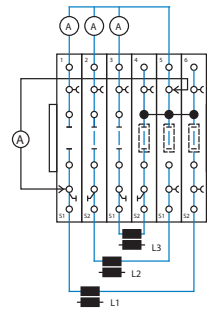

Comparison measurement for L1

Sequence for test :

- 1) Remove SLS4 screw from terminal 1.
- 2) Connect ammeter to test sockets of terminal 1 and 5.
- 3) Open disconnect slide link of terminal 1.

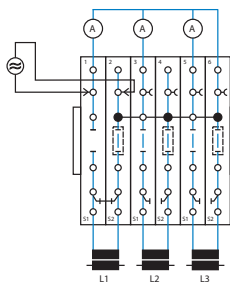

Meter test for L1 through
external power supply

Sequence for test :

- 1) Close short circuit slide SLS2 of terminals 1 and 2.
- 2) Open disconnect slide link of terminal 1.
- 3) Connect external power supply to test sockets of terminals 1 and 2.

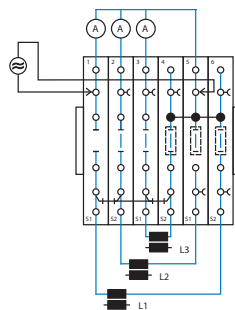

Meter test for L1 through
external power supply

Sequence for test :

- 1) Close short circuit slide SLS4 of terminals 1, 2, 3 and 4.
- 2) Open disconnect slide link of terminal 1.
- 3) Connect external power supply to test sockets of terminals 1 and 5.

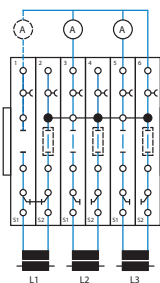

Changing the meter for L1

Sequence for test :

- 1) Close short circuit slide SLS2 of terminals 1 and 2.
- 2) Open disconnect slide link of terminal 1.
- 3) Disconnect meter for L1.

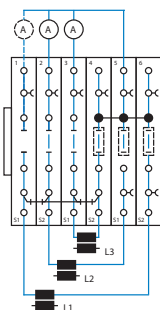

Changing the meter for L1

Sequence for test :

- 1) Close short circuit slide SLS4 of terminals 1, 2, 3 and 4.
- 2) Open disconnect slide link of terminal 1.
- 3) Disconnect meter for L1.

Usage of CDS6U range of products in 3 Phase Power Meter (KWh Meter) Test Set

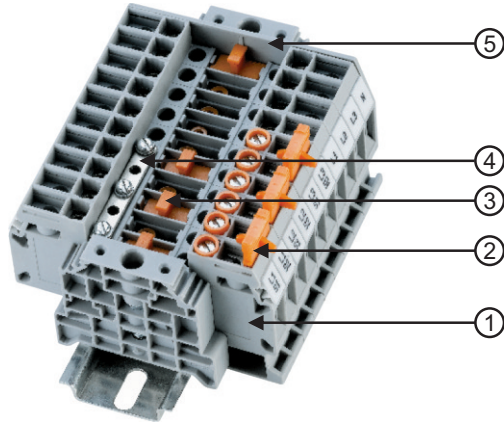

No.	Cat. No.	Qty.
1	CDS6U	10
2	SLS2	3
3	LCCDS	4
4	CA723/5	1
5	EPCDS6U	1

Operating status
(with internal distribution of the k-point)

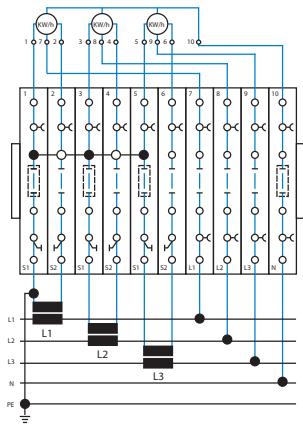

SLS2 in open condition

Meter test for L1 through external power supply

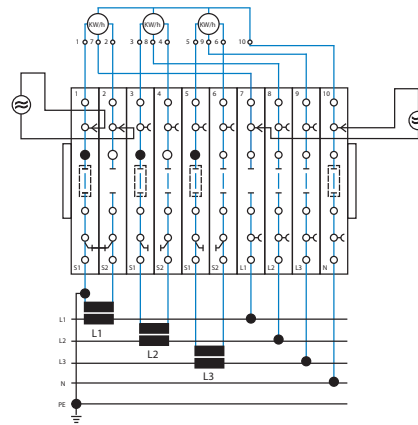

Closing of SLS2

Sequence for test :

- 1) Close short circuit slide SLS2 of terminals 1 and 2.
- 2) Open disconnect slide link of terminal 2 and 7.
- 3) Connect external power supply to test sockets of terminals 1, 2 and 7, 10.

Comparison measurement for L1

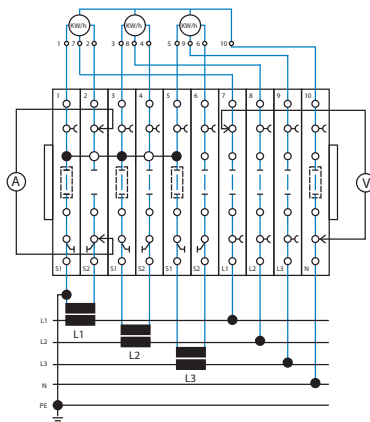

SLS2 in open condition

Sequence for test :

- 1) Remove SLS2 screw from terminal 2.
- 2) Connect ammeter to test sockets of terminal 2.
- 3) Open disconnect slide link of terminal 2.
- 4) Connect voltmeter to test sockets of terminals 7 and 10.

Changing the meter for L1

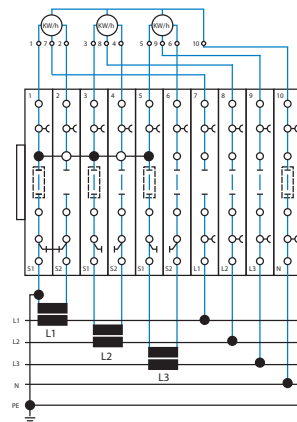

Closing of SLS2

Sequence for test :

- 1) Close short circuit slide SLS2 of terminals 1 and 2.
- 2) Open disconnect slide link of terminal 2 and 7.
- 3) Disconnect meter for L1 at terminals 1, 2 and 7.



Altech's popular industrial enclosures keep you covered with their high quality and attractive design.

All at Very Competitive Prices ... and many available for immediate delivery!

Customization available!

- Polycarbonate/Polystyrene enclosures will last indefinitely without corrosion
- Non-metallic enclosures withstand bumps and blows, they will not dent
- Surface finish does not deteriorate and requires no special painting or refinishing
- Resist weak and strong acids and alkali
- Non-metallic enclosures weigh significantly less than metal, simplifying handling
- Enclosures can be easily customized

TK Series



- 16 different enclosures with up to 3 different cover heights
- Polystyrene or Polycarbonate
- IP66 (NEMA 4X)
- 50 x 52 x 35 to 360 x 254 x 165 mm

TG Series



- 16 sizes available
- ABS or Polycarbonate
- IP67 (NEMA TYPE 4X)
- Recessed Cover
- 84 x 82 x 55 to 302 x 232 x 110 mm

AL Series



- IP65 protection, which is necessary for industry approval.
- Aluminum
- High degree of resistance to chemicals and other damaging materials.
- 50 x 45 x 30 to 330 x 230 x 110 mm

Abox Series



- Two to four high grade self tapping screws secure the lid non-flammable
- non-flammable Polystyrene
- Tongue and groove sealing system with polyurethane gasket
- 80 x 80 x 52 to 250 x 250 x 115 mm

Abox-i Series



- 6 different sizes
- For harsh environments
- Glass reinforced Polycarbonate
- Impervious to sea air and water
- 80 x 80 x 52 to 250 x 250 x 115 mm

AKL Series



- Low and high covers in gray or tinted transparent
- Enclosures are combinable
- IP65 protection
- 150 x 300 x 132 to 600 x 300 x 210 mm

EK Series



- UL listed
- IP65 protection
- Dust and moisture proof
- Polycarbonate
- 130 x 94 x 80 to 361 x 254 x 110 mm

AK Series



- IEC protection
- Up to IP65 protection
- Dust and moisture proof
- Polystyrene or Polycarbonate
- 100 x 150 x 96 to 900 x 300 x 142 mm

HP Series



- Junction boxes
- IP55 protection
- Dust and moisture proof
- Semi rigid polypropylene
- 75 x 75 x 42 to 199 x 149 x 70 mm

PB Series



- Universal fit for nearly all 22.5mm diameter push buttons
- UV, weather and impact resistant
- IP66 (NEMA 4X) capable
- 94 x 94 x 81 to 180 x 94 x 81 mm

Accessories



- Liquid Tight Strain Relief connectors and connector assemblies
- Mounting plates
- DIN rail support racks
- Key locksets, Hinge kits and more

Technical Information

CHART # International Protection (IP) Ratings to IEC 529

Protection Degree	NEMA Rating	Second Digit - Degree of Water Protection					
		0	1	2	3	4	5
IP 00							
IP 01							
IP 02							
IP 11							
IP 12							
IP 13							
IP 14							
IP 21							
IP 22							
IP 23							
IP 24							
IP 31							
IP 32							
IP 33							
IP 34							
IP 41							
IP 42							
IP 43							
IP 44							
IP 51							
IP 52							
IP 53							
IP 54							
IP 61							
IP 62							
IP 63							
IP 64							

Distribution Block

Altech CDB Compact Distribution Blocks are an ideal choice for a simplified distribution system. A lug/bolt secures the incoming cable and the screw clamp design of the block provides the outgoing connections. These provide easy connect points and ensure perfect continuity for distribution. A protective shield effectively shrouds the incoming connection.

Application Information:

Sum of outgoing currents on either side of center should not exceed half the maximum permissible incoming current.

Sum of total outgoing currents should not exceed maximum permissible incoming current.

Connection for higher outgoing currents should be done through the terminal nearest to the incoming connection.

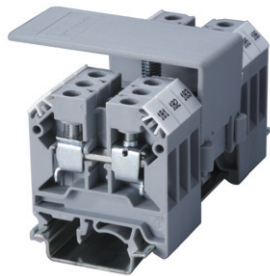

CDB4/x*

CDB4/x(1)**

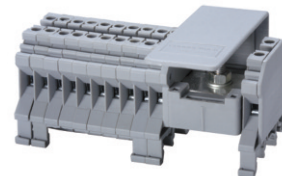
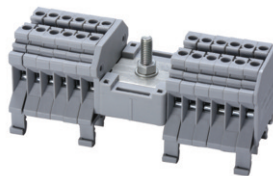

Terminal Width	6 mm			6 mm			
Height & Width	45 x 43 mm			45 x 43 mm			
Stripping Length	8 mm			8 mm			
Insulation Material	Polyamide 6.6			Polyamide 6.6			
Type of Connection	Input	1 Lug/ M5 bolt connection for ring lug			Output	1 Lug M5 /bolt connection for ring lug	
	Output	Screw clamp connection			Output	Screw clamp connection	
Approvals							
Wire Range	Input	10-8 AWG	6-16 sq.mm	10-8 AWG	10-8 AWG	6-16 sq.mm	10-8 AWG
	Output	22-12 AWG	0.2-4 sq.mm	22-10 AWG	22-12 AWG	0.5-4 sq.mm	22-10 AWG
Voltage Rating	600 V		800 V	600 V		800 V	600 V
Current Rating	Input	50 A	64 A	50 A	50 A	64 A	50 A
	Max. Individual Output	25 A	32 A	35 A	25 A	64 A	35 A
Torque	Input	26 lb-in	2.0 Nm	26 lb-in	26 lb-in	2.0 Nm	26 lb-in
	Output	7 lb-in	0.5 Nm	7 lb-in	7 lb-in	0.5 Nm	7 lb-in

Other Approvals



Terminal Block

Cat. No.	H x W x L (mm)	Outputs	Std. Pk.	Cat. No.	H x W x L (mm)	Outputs	Std. Pk.
CDB4/1	45 x 43 x 44	4	10	CDB4/2(1)	45 x 43 x 52	6	10
CDB4/2	45 x 43 x 56	8	10	CDB4/3(1)	45 x 43 x 58	8	10
CDB4/3	45 x 43 x 68	12	10	CDB4/4(1)	45 x 43 x 64	10	10
CDB4/4	45 x 43 x 80	16	10	CDB4/5(1)	45 x 43 x 70	12	10
CDB4/5	45 x 43 x 96	20	10	CDB4/6(1)	45 x 43 x 76	14	10
CDB4/6	45 x 43 x 108	24	10	CDB4/10(1)	45 x 43 x 100	22	10
				CDB4/11(1)	45 x 43 x 106	24	10

Cat. No. Std. Pk.

Cat. No. Std. Pk.

DIN Rail for ordering information refer to pages 90-91

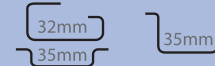

End Stop for ordering information refer to page 92



CA702 50
CA802 50

CA702 50
CA802 50

Marking Tags



MT6 100

MT6 100

Warning Label

COLOR BLOCKS
(other than standard grey)

When ordering please add color suffix to Cat. No.

Example for color Red: **Cat.No./R**

Color	Ordering Suffix	
Red	R	
Yellow	Y	
Blue	BU	
Green	G	
Consult Altech for availability.		
Orange	O	
Beige	BG	
Dark Brown	DB	
Black	BL	
White	W	

* NOTE:
x signifies how many blocks are on each side of input.

** NOTE:
x signifies number of blocks on left side of input. 1 block is on right side.

CDB6/x*

CDB10/x*

CDB25/x*

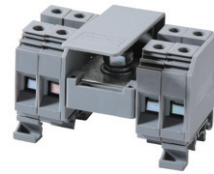
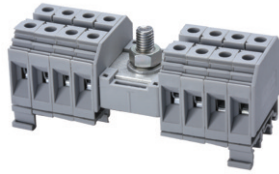
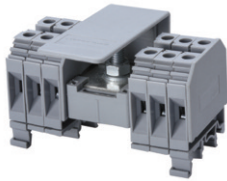

8 mm

10 mm

12 mm

43 x 47 mm

43 x 47 mm

56 x 49 mm

12 mm

12 mm

18 mm

Polyamide 6.6

Polyamide 6.6

Polyamide 6.6

1 Lug/ M6 bolt connection for ring lug
Screw clamp connection

1 Lug/ M8 bolt connection for ring lug
Screw clamp connection

1 Lug/ M8 bolt connection for ring lug
Screw clamp connection

CDB6/x			CDB10/x			CDB25/x		
SP US	IEC	UL US	SP US	IEC	UL US	SP US	IEC	UL US
C 60947-7-1	60947-7-1	C E220514	C 60947-7-1	60947-7-1	C E220514	C 60947-7-1	60947-7-1	C E220514
10-2 AWG 22-8 AWG	6-25 sq.mm 1.5-6 sq.mm	10-2 AWG 22-8 AWG	8-1/0 AWG 22-6 AWG	10-35 sq.mm 1.5-10 sq.mm	8-1/0 AWG 16-6 AWG	6-2/0 AWG 12-2 AWG	10-50 sq.mm 6-25 sq.mm	6-2/0 AWG 12-2 AWG
600 V	800 V	600 V	600 V	800 V	600 V	600 V	800 V	600 V
100 A 50 A	82 A 41 A	100 A 50 A	130 A 65 A	114 A 57 A	130 A 65 A	150 A 75 A	150 A 75 A	150 A 75 A
35 lb-in 14 lb-in	3.0 Nm 0.8 Nm	35 lb-in 14 lb-in	53 lb-in 14 lb-in	6.0 Nm 1.2 Nm	53 lb-in 14 lb-in	53 lb-in 22 lb-in	6.0 Nm 2 Nm	53 lb-in 22 lb-in









Cat. No.	H x W x L (mm)	Outputs	Std. Pk.	Cat. No.	H x W x L (mm)	Outputs	Std. Pk.	Cat. No.	H x W x L (mm)	Outputs	Std. Pk.
CDB6/2	43 x 47 x 64	8	10	CDB10/2	43 x 47 x 72	8	10	CDB25/2	56 x 49 x 88	8	10
CDB6/3	43 x 47 x 80	12	10	CDB10/3	43 x 47 x 92	12	10	CDB25/3	56 x 49 x 112	12	10
CDB6/4	43 x 47 x 96	16	5	CDB10/4	43 x 47 x 112	16	5	CDB25/4	56 x 49 x 136	16	5

Cat. No.	Std. Pk.	Cat. No.	Std. Pk.	Cat. No.	Std. Pk.
	50		50		50
CA702	50	CA702	50	CA702	50
CA802	50	CA802	50	CA802	50
MT8	100	MT10	100	MT12	100
SWL6	100				

* NOTE:
x signifies how many blocks are on each side of input.

Distribution Block

CMDB blocks are the modified version of CDB terminal blocks without central incoming terminal connections.

	CMDB4/x	CMDB6/x	CMDB10/x
Terminal Width	6 mm	8 mm	10 mm
Height & Width	45 x 43 mm	43 x 47 mm	43 x 47 mm
Stripping Length	9 mm	12 mm	12 mm
Insulation Material	Polyamide 6.6	Polyamide 6.6	Polyamide 6.6
Type of Connection	Screw clamp connection	Screw clamp connection	Screw clamp connection
Approvals	 	 	 
Wire Range	0.2-4 sq.mm 22-10 AWG	1.5-6 sq.mm 22-8 AWG	1.5-10 sq.mm 22-6 AWG
Voltage Rating	1000 V 600 V	1000 V 600 V	1000 V 600 V
Current Rating	32 A 35 A	41 A 50 A	57 A 65 A
Torque	0.5 Nm 7 lb-in	0.8 Nm 14 lb-in	1.2 Nm 14 lb-in

Other Approvals

		
---	---	---

Terminal Block

Cat. No.	H x W x L	Outputs	Std. Pk.	Cat. No.	H x W x L	Outputs	Std. Pk.	Cat. No.	H x W x L	Outputs	Std. Pk.
CMDB4/2	45 x 43 x 13.5	4	10	CMDB6/2	43 x 48 x 17.5	4	10	CMDB10/2	43 x 48 x 21.5	4	10
CMDB4/3	45 x 43 x 19.5	6	10	CMDB6/3	43 x 48 x 25.5	6	10	CMDB10/3	43 x 48 x 31.5	6	10
CMDB4/4	45 x 43 x 25.5	8	5	CMDB6/4	43 x 48 x 33.5	8	10	CMDB10/4	43 x 48 x 41.5	8	10
CMDB4/10	45 x 43 x 61.5	20	5	CMDB6/10	43 x 48 x 81.5	20	5	CMDB10/10	43 x 48 x 101.5	20	5

Cat. No.	Std. Pk.	Cat. No.	Std. Pk.	Cat. No.	Std. Pk.
CA702	50	CA702	50	CA702	50
CA802	50	CA802	50	CA802	50

DIN Rail for ordering information refer to pages 90-91			
--	---	--	---

End Stop for ordering information refer to page 92		CA702 50 CA802 50	CA702 50 CA802 50	CA702 50 CA802 50
--	---	--------------------------------	--------------------------------	--------------------------------











Marking Tags 	MT6 100	MT8 100	MT10 100
--	--------------	--------------	---------------

Warning Label	SWL6 100		
---------------	---------------	--	--

COLOR BLOCKS
(other than standard grey)

When ordering please add color suffix to Cat. No.

Example for color Red: **Cat.No./R**

Color	Ordering Suffix	
Red	R	
Yellow	Y	
Blue	BU	
Green	G	
Consult Altech for availability.		
Orange	O	
Beige	BG	
Dark Brown	DB	
Black	BL	
White	W	

We have a full line of standard and custom Interface Modules and Power Supplies.

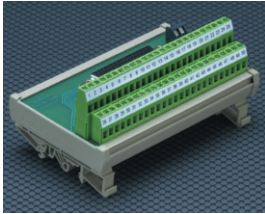

CONNECTOR TO TERMINAL BLOCK MODULES

Compact and reliable connections between high density connectors and high quality screw-cage clamp terminal blocks; DIN Rail mountable

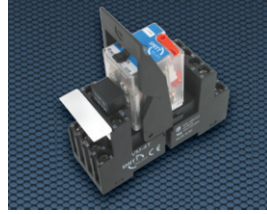

GENERAL PURPOSE/INTERFACE RELAYS

A selection of DIN Rail mountable general purpose relays available for up to 12 A @ 250 Volts.

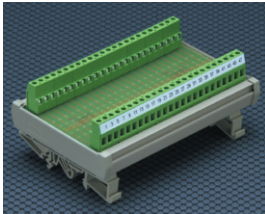

DIODE MODULES & COMPONENT CARRIERS

Add additional components to build circuits and diode modules mounted on 35 or 32mm DIN Rails.

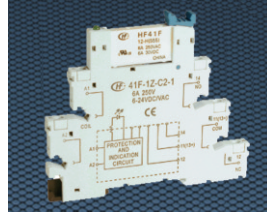

PLUGGABLE SLIMLINE RELAYS

Need Text



MONITORING PROTECTION MODULES

Special purpose components connected to screw-cage clamp terminal blocks; DIN Rail mountable.

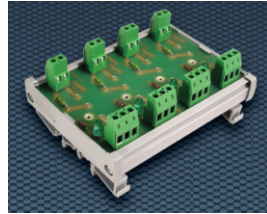

I/O MODULE CARRIERS

Accepts industry standard I/O modules. LED indicator and fuse protection included on carrier.

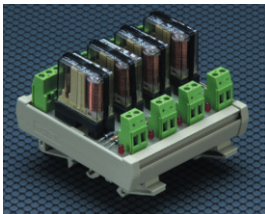

RELAY MODULES

Traditional relay modules from 1-16 channels. Available in several voltages (AC & DC), isolated or bussed systems. DIN Rail mounted.

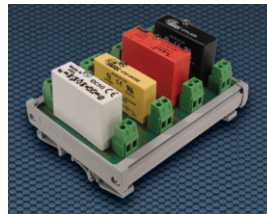

SOLID STATE I/O MODULES

Input/Output Modules (both AC and DC) provided on a DIN mountable module. Bussed and isolated versions available.



SAFETY RELAY MODULES

Force-guided contact modules available in 1-16 channels, 12 and 24VDC coils and isolated or bussed systems. All mountable on 32 or 35mm DIN Rails.



POWER SUPPLIES

Basic and High Performance Series. DIN Rail mountable units are available with 12 or 24VDC output, 15 to 60 Watts and regulated outputs.

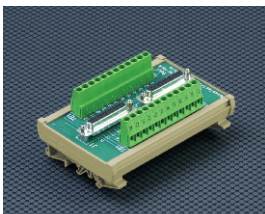

CUSTOM MODULES

Altech provides quick turn-key custom designs and competitive solutions.

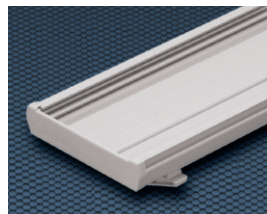

MOUNTING TRACKS

DIN Rail or panel mount mounting tracks secure standard or custom printed circuit boards in control panels or cabinets.

Contact Altech Today to learn more!

One Phase Power Distribution Block

- Quick mounting and wiring
- IP20 Finger Safe
- DIN Rail or Panel Mount
- Blocks fit with other DIN Rail mountable modular devices (height 95mm, depth 44.5mm)
- Accessories increase the number of outputs with only one input (applies **only** to 38041 and 38032)
- No caps to open / remove
- Material
Housing: Polyamide
Metal Body: Brass



Part Number:	DB16*		38049		DB35*		38041	
Approvals	UL File E220514		UL File E98082		UL File E220514		UL File E98082	
Current Rating	80A	80A	80A	80A	115A	125A	115A	125A
Voltage Rating	600V AC	1000V AC	600V AC	690V AC	600V AC	1000V AC	600V AC	690V AC
SCCR	10kA		100kA		10kA		100kA	
No. of Inputs	1	1	1	1	1	1	1	1
Wire Range	8-4 AWG	6-16mm ²	8-4 AWG	6-16mm ²	8-2 AWG	10-35mm ²	8-2 AWG	10-35mm ²
Torque	14lb.-in.	1.2Nm	14lb.-in.	1.5Nm	40lb.-in.	6Nm	13.5lb.-in.	3.5Nm
Screw Type	Pozi Drive 2		Pozi Drive 2		Pozi Drive 2		Pozi Drive 2	
No. of Outputs	6	6	6	6	6	6	6	6
Wire Range	(2x)8-4 AWG	(2x)6-16mm ²	(2x)8-4 AWG	(2x)6-16mm ²	14-6 AWG	2.5-10mm ²	14-6 AWG	2.5-16mm ²
Torque	14lb.-in.	12Nm	14lb.-in.	1.5Nm	17.5lb.-in.	2Nm	17.5lb.-in.	2Nm
Wire Range	(4x)14-10 AWG	(4x)2.5-6mm ²	(4x)14-10 AWG	(4x)2.5-6mm ²	8-4 AWG	6-16mm ²		
Torque	7lb.-in.	7Nm	7.2lb.-in.	0.8Nm	14lb.-in.	3Nm		
Screw Type	Pozi Drive 2		Pozi Drive 2		Pozi Drive 2		Pozi Drive 2	

Optional Marking Tag
** (for DB16 and DB35)

Dimensions:

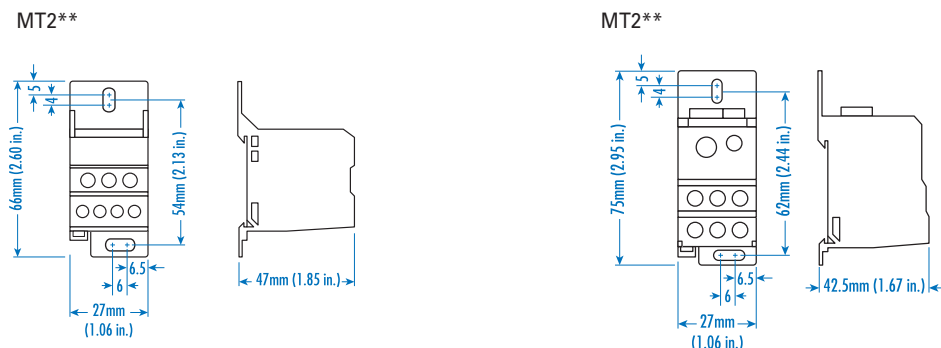

COLOR BLOCKS	
(other than standard grey)	
When ordering please add color suffix to Cat. No.	
Example for color Red: Cat.No./R	
Color	Ordering Suffix
Red	R
Yellow	Y
Blue	BU
Green	G
Consult Altech for availability:	
Orange	O
Beige	BG
Dark Brown	DB
Black	BL
White	W

38041

Fork Type Busbar 38045

Accessories: Fork Type Busbar
Part No: **38045** to jump 2 Blocks
38046 to jump 8 Blocks can be cut

38076

38032

38074



CE

CE

CE

Part Number:	38076		38032		38074	
Approvals	UL File E98082		UL File E98082	C US		UL File E98082
Current Rating	115A	125A	160A	160A	175A	175A
Voltage Rating	600V AC	690V AC	600V AC	690V AC	600V AC	690V AC
SCCR	100kA		100kA		100kA	
No. of Inputs	1	1	1	1	1	1
Wire Range	8-2 AWG	10-35mm ²	8-2/0AWG	10-70mm ²	6-2/0AWG	16-70mm ²
Torque	53lb.-in.	6Nm	35.5lb.-in.	4Nm	53lb.-in.	6Nm
Screw Type	Hex 4		Hex 5		Hex 5	
No. of Outputs	10	10	6	6	10	10
Wire Range	14-4 AWG	2.5-16mm ²	14-6 AWG	2.5-16mm ²	14-4 AWG	2.5-16mm ²
Torque	26.5lb.-in.	3Nm	17.5lb.-in.	2Nm	26.5lb.-in.	3Nm
Screw Type	Hex 3		Hex 3		Hex 3	

Dimensions:

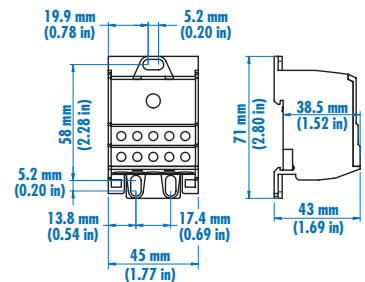
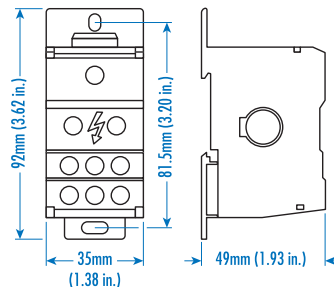
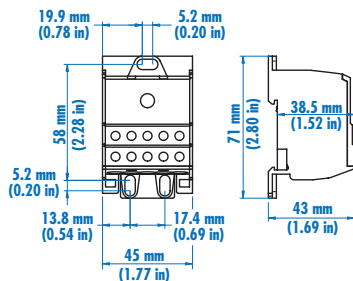

38032

Accessories: Copper Jumper Bar (6x15 mm)
 Part No: **3803221** for 2 Blocks
3803231 for 3 Blocks
3803241 for 4 Blocks
 can be cut

One Phase Power Distribution Block

- Quick mounting and wiring
- IP20 Finger Safe
- DIN Rail or Panel Mount
- Blocks fit with other DIN Rail mountable modular devices (height 95mm, depth 44.5mm)
- Accessories increase the number of outputs with only one input.
- No caps to open or remove
- Material
 - Housing: Polyamide
 - Metal Body: Brass





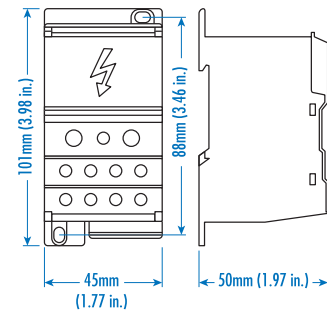
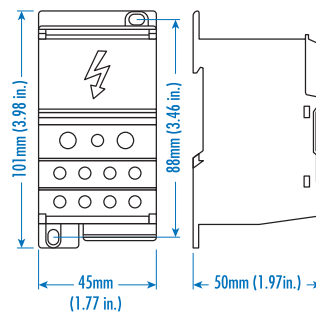

Part Number:	38020		38019			
Approvals	UL File E98082	C SP US	IEC	UL File E98082	C SP US	IEC
Current Rating	230A	250A	310A	400A		
Voltage Rating	600V AC	690V AC	600V AC	690V AC		
SCCR	100kA		100kA			
No. of Inputs	1	1	1	1		
Wire Range	2-4/0AWG	35-120mm ²	3/0-350mcm	95-185mm ²		
Torque	170lb.-in.	19Nm	230lb.-in.	25Nm		
Screw Type	Hex 6		Hex 8			
No. of Outputs	11	11	11	11		
Wire Range	(2x) 14-2AWG	(2x) 2.5-35mm ²	(2x) 14-2AWG	(2x) 2.5-35mm ²		
Torque	31lb.-in.	3.5Nm	31lb.-in.	3.5Nm		
Wire Range	(5x) 14-6AWG	(5x) 2.5-16mm ²	(5x) 14-6AWG	(5x) 2.5-16mm ²		
Torque	17.5lb.-in.	2Nm	17.5lb.-in.	2Nm		
Wire Range	(4x) 14-8AWG	(4x) 2.5-10mm ²	(4x) 14-8AWG	(4x) 2.5-10mm ²		
Torque	17.5lb.-in.	2Nm	17.5lb.-in.	2Nm		
Screw Type	standard screwdriver		standard screwdriver			

Dimensions:

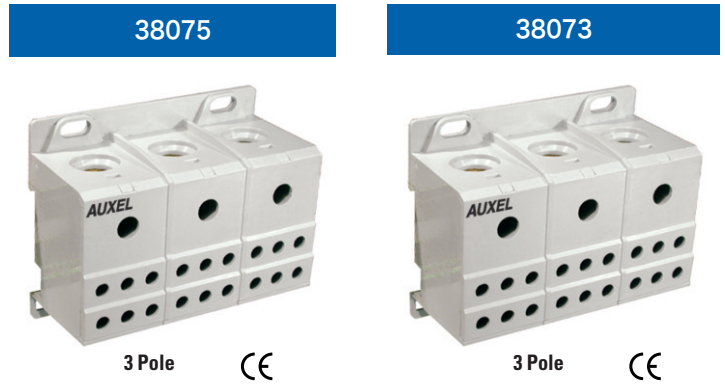

- Quick mounting and wiring
- IP20 Finger Safe
- DIN Rail or Panel Mount
- Blocks fit with other DIN Rail mountable modular devices
- Same compact size for both ratings
- No caps to open or remove
- Material
Housing: Polyamide
Metal Body: Brass



Part Number:	38075		38073	
Approvals	 UL File E98082		 UL File E98082	
Current Rating	115A	115A	175A	175A
Voltage Rating	600V AC	690V AC	600V AC	690V AC
SCCR	100kA		100kA	
No. of Inputs	3x1	3x1	3x1	3x1
Wire Range	8-2AWG	10-35mm ²	8-2/0AWG	10-70mm ²
Torque	31lb.-in.	3.5Nm	35.5lb.-in.	4Nm
Screw Type	Hex 4		Hex 5	
No. of Outputs	3x6	3x6	3x6	3x6
Wire Range	14-4AWG	2.5-16mm ²	14-4AWG	2.5-16mm ²
Torque	17.5lb.-in.	2Nm	17.5 lb.-in.	2Nm
Screw Type	Hex 3		Hex 3	

Dimensions:

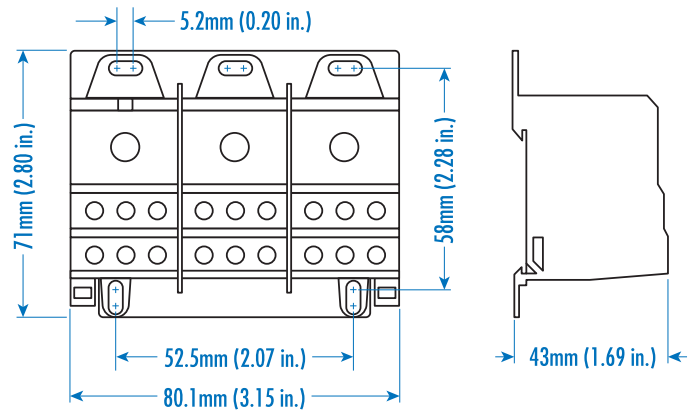

Splicer Blocks

- Quick mounting and wiring
- IP20 Finger Safe
- DIN Rail or Panel Mount
- No caps to open or remove
- Material

Housing: Polyamide
Metal Body: Aluminum

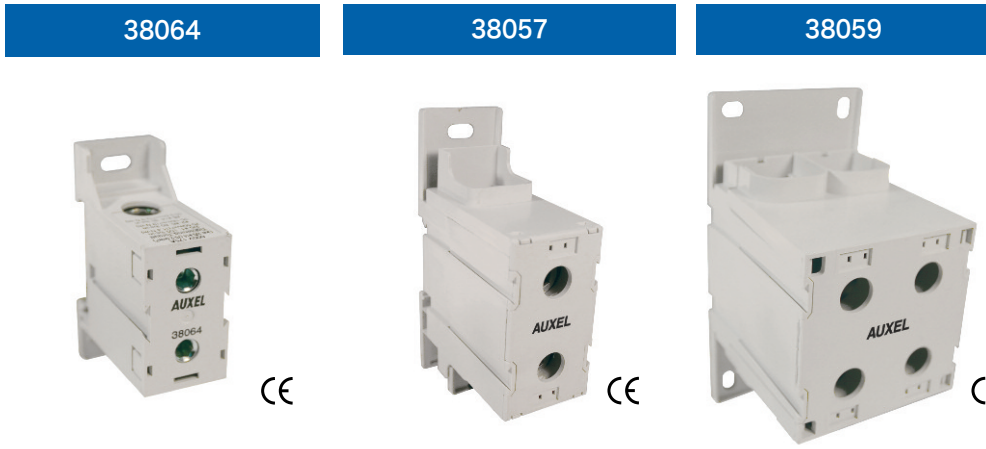

Part Number:

38064

38057

38059

Approvals	 		 		 	
Current Rating	175A	175A	335A	400A	840A	800A
Voltage Rating	600V AC	690V AC	600V AC	690V AC	600V AC	690V AC
No. of Inputs	1	1	1	1	2	2
Wire Range	14-1AWG	2.5mm ² -50mm ²	6AWG-400MCM	16mm ² -185mm ²	3AWG-600MCM	25-300mm ²
Torque	106.2lb.-in.	12Nm	221lb.-in.	25Nm	310lb.-in.	35Nm
Screw Type	Hex 5		Hex 10		Hex 10	
No. of Outputs	1	1	1	1	2	2
Wire Range	14-1AWG	2.5mm ² -50mm ²	6AWG-400MCM	16mm ² -185mm ²	3AWG-600MCM	25-300mm ²
Torque	106.2lb.-in.	12Nm	221lb.-in.	25Nm	310lb.-in.	35Nm
Screw Type	Hex 5		Hex 10		Hex 10	

Dimensions:

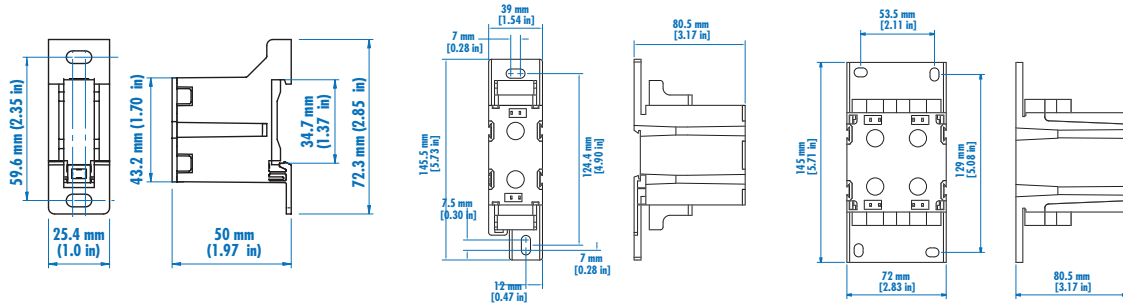

Altech thermocouple terminal blocks are designed for use in temperature measuring circuits.

The current carrying part of the terminal blocks have the same material (according to DIN437134 and DIN43714) which is used for compensating cables in the temperature measurement circuit (up to 200°C).

The terminal block is marked for the respective type of thermocouple which enables easy identification for wiring.

*

- CTT2.5UK 'K' type - Chromel (NiCr) Alumel (NiAl)
- CTT2.5UJ 'J' type - Iron (Fe) Constantan (CuNi)
- CTT2.5UT 'T' type - Copper (Cu) Constantan (CuNi)
- CTT2.5UE 'E' type - Chromel (NiCr) Constantan (CuNi)





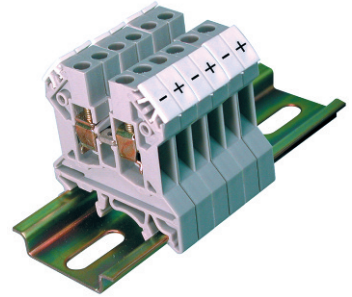

CTT2.5UK/J/T/E



Terminal Width	10 mm
Height x Length	45 x 43 mm
Stripping Length	8 mm
Insulation Material	Polyamide 6.6
Current Carrying Material	*
Type of Connection	4 screw clamps
Wire Range	24-12 AWG
Voltage Rating	300 V
Current Rating	10 A
Torque	7 lb-in

Cat. No.	Std. Pk.
----------	----------

Terminal Block	CTT2.5UK	50
	CTT2.5UJ	50
	CTT2.5UT	50
	CTT2.5UE	50
End Plate 	EP2.5/4UN	50
Isolation Plate 	PP2.5/4UN	50
DIN Rail <i>for ordering information refer to page 63</i>		
End Clamp 	CA802	100
	CA702	100
Marking Tags (MT Type) 	included	

Indicator/ Diode Circuit

Altech offers different types of terminals incorporating electronic components for signal converting, circuit protection and status indication. Based on customer requirements, specially assembled terminals are offered.

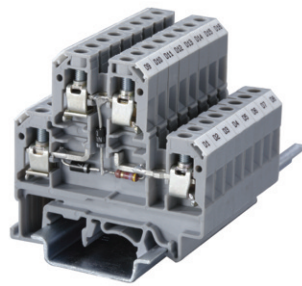

CDL4U(E)D1/D2

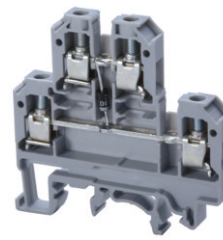

With arc suppression circuit for contactors and solenoid valves - DC

CDL4U(E)D3

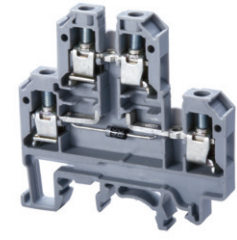

Diode circuit for reverse polarity protection

Terminal Width	6 mm			6 mm		
Height x Length	54 x 55.5 mm			54 x 55.5 mm		
Terminal Voltage	300 V~			300 V~		
Stripping Length	9 mm			9 mm		
Insulation Material	Polyamide 6.6			Polyamide 6.6		
Approvals						
Wire Range	22-10 AWG	0.2-4 sq.mm	22-10 AWG	22-10 AWG	0.2-4 sq.mm	22-10 AWG
Voltage Rating	300 V	500 V	600 V	300 V	500 V	600 V
Current Rating	25 A	32 A	35 A	25 A	32 A	35 A
Torque	7 lb-in	0.5 Nm	7 lb-in	7 lb-in	0.5 Nm	7 lb-in

Other Approvals



Terminal Block

End Plate

DIN Rail for ordering information refer to pages 90-91

End Stop for ordering information refer to page 92

Internal Jumper 2 pole
3 pole
4 pole
10 pole

Current Bars 2 pole
3 pole
4 pole
10 pole
10 pole (breakable)
100 pole

Shorting Sleeve & Screw

Marking Tags

Diode Specifications

Diode	1N 4007
Diode Reverse Voltage	1000 V
Diode Current	1 A

Cat. No.	Std. Pk.	Cat. No.	Std. Pk.
CDL4U(E)D1 CDL4U(E)D2	100 100	CDL4U(E)D3	100
EPCDL4U	50	EPCDL4U	50
CA702 CA802	50 50	CA702 CA802	50 50
CA727/2 CA727/3 CA727/4 CA727/10	100 100 100 10	CA727/2 CA727/3 CA727/4 CA727/10	100 100 100 10
CA703/1 CA704/2 CA705/3 CA732/10 CA732/10-A CA732/100	100 100 100 100 100 10	CA703/1 CA704/2 CA705/3 CA732/10 CA732/10-A CA732/100	100 100 100 100 100 10
CA607/S/Q	100	CA607/S/Q	100
MT2	100	MT2	100

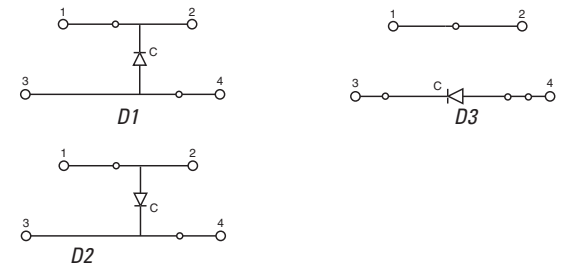

COLOR BLOCKS
(other than standard grey)

When ordering please add color suffix to Cat. No.

Example for color Red: **Cat.No./R**

Color	Ordering Suffix	
Red	R	
Yellow	Y	
Blue	BU	
Green	G	
Orange	O	
Beige	BG	
Dark Brown	DB	
Black	BL	
White	W	

Consult Altech for availability.

CDL4U(E)DD1/DD2

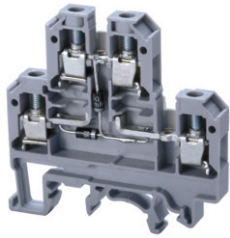

Diode circuit for lamp testing

6 mm

54 x 55.5 mm

300 V~

9 mm

Polyamide 6.6

C US	60947-7-1	C US E220514
22-10 AWG	0.2-4 sq.mm	22-10 AWG
300 V	500 V	600 V
25 A	32 A	35 A
7 lb-in	0.5 Nm	7 lb-in



Cat. No.	Std. Pk.
CDL4U(E)DD1	100
CDL4U(E)DD2	100
EPCDL4U	50



CA702	50
CA802	50

CA727/2	100
CA727/3	100
CA727/4	100
CA727/10	10

CA703/1	100
CA704/1	100
CA705/1	100
CA732/10	100
CA732/10-A	100
CA732/100	10

CA607/S/Q	100
-----------	-----

MT2	100
-----	-----

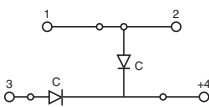

DD1

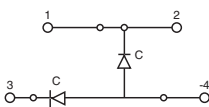

DD2

CDL4U(E)DD3/DD4

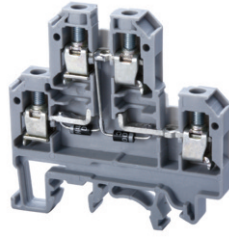

Diode circuit for lamp testing

6 mm

54 x 55.5 mm

300 V~

9 mm

Polyamide 6.6

C US	60947-7-1	C US E220514
22-10 AWG	0.2-4 sq.mm	22-10 AWG
300 V	500 V	600 V
25 A	32 A	35 A
7 lb-in	0.5 Nm	7 lb-in



Cat. No.	Std. Pk.
CDL4U(E)DD3	100
CDL4U(E)DD4	100
EPCDL4U	50



CA702	50
CA802	50

CA727/2	100
CA727/3	100
CA727/4	100
CA727/10	10

CA703/1	100
CA704/1	100
CA705/1	100
CA732/10	100
CA732/10-A	100
CA732/100	10

CA607/S/Q	100
-----------	-----

MT2	100
-----	-----

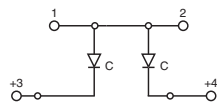

DD3

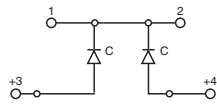

DD4

CDL4U(E)D4

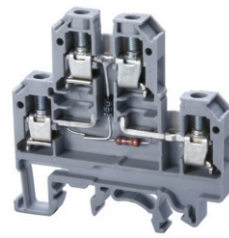

Diode circuit for lamp testing with LED series resistance

6 mm

54 x 55.5 mm

12V~/24 V~

9 mm

Polyamide 6.6

C US	60947-7-1	C US E220514
22-10 AWG	0.2-4 sq.mm	22-10 AWG
300 V	500 V	600 V
25 A	32 A	35 A
7 lb-in	0.5 Nm	7 lb-in



Cat. No.	Std. Pk.
CDL4U(E)D4	100
EPCDL4U	50



CA702	50
CA802	50

CA727/2	100
CA727/3	100
CA727/4	100
CA727/10	10

CA703/1	100
CA704/1	100
CA705/1	100
CA732/10	100
CA732/10-A	100
CA732/100	10

CA607/S/Q	100
-----------	-----

MT2	100
-----	-----

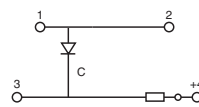

D4

CDL4U(E)DD5

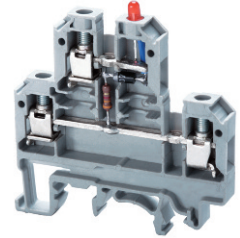

Diode circuit for lamp testing with LED series resistance

6 mm

54 x 55.5 mm

12V~/24 V~

9 mm

Polyamide 6.6

C US	60947-7-1	C US E220514
22-10 AWG	0.2-4 sq.mm	22-10 AWG
300 V	500 V	600 V
25 A	32 A	35 A
7 lb-in	0.5 Nm	7 lb-in



Cat. No.	Std. Pk.
CDL4U(E)DD5	100
EPCDL4U	50



CA702	50
CA802	50

CA727/2	100
CA727/3	100
CA727/4	100
CA727/10	10

CA703/1	100
CA704/1	100
CA705/1	100
CA732/10	100
CA732/10-A	100
CA732/100	10

CA607/S/Q	100
-----------	-----

MT2	100
-----	-----

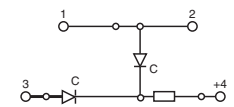

DD5

Indicator/ Diode Circuit

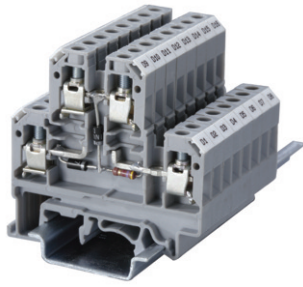

CDL4U(E)N1

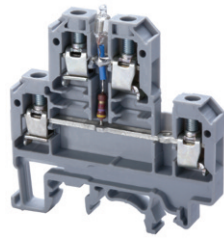

AC voltage indicator with neon lamp

CDL4U(E)LD5*

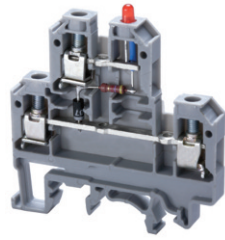

AC voltage indicator with LED

CDL4U(E)LD3*

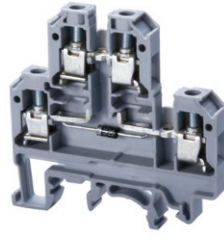

AC/ DC voltage indicator with LED

Terminal Width	6 mm			6 mm			6 mm		
Height x Length	54 x 55.5 mm			54 x 55.5 mm			54 x 55.5 mm		
Terminal Voltage	110 V~ to 220 V~			24 V~, 48 V~, 120V~, 220V~			12 V~, 24 V~		
Stripping Length	9 mm			9 mm			9 mm		
Insulation Material	Polyamide 6.6			Polyamide 6.6			Polyamide 6.6		
Approvals									
Wire Range	22-10 AWG	0.2-4 sq.mm	22-10 AWG	22-10 AWG	0.2-4 sq.mm	22-10 AWG	22-10 AWG	0.2-4 sq.mm	22-10 AWG
Voltage Rating	300 V	500 V	600 V	300 V	500 V	600 V	300 V	500 V	600 V
Current Rating	25 A	32 A	35 A	25 A	32 A	35 A	25 A	32 A	35 A
Torque	7 lb-in	0.5 Nm	7 lb-in	7 lb-in	0.5 Nm	7 lb-in	7 lb-in	0.5 Nm	7 lb-in

Other Approvals									
-----------------	--	--	--	--	--	--	--	--	--

	Cat. No.	Std. Pk.	Cat. No.	Std. Pk.	Cat. No.	Std. Pk.
Terminal Block	CDL4U(E)N1	50	CDL4U(E)LD5*	50	CDL4U(E)LD3*	50

End Plate	EPCDL4U	50	EPCDL4U	50	EPCDL4U	50
-----------	---------	----	---------	----	---------	----



End Stop for ordering information refer to page 92	CA702 CA802	50 50	CA702 CA802	50 50	CA702 CA802	50 50
--	----------------	----------	----------------	----------	----------------	----------

Internal Jumper	2 pole	CA727/2	100	CA727/2	100	CA727/2	100
	3 pole	CA727/3	100	CA727/3	100	CA727/3	100
	4 pole	CA727/4	100	CA727/4	100	CA727/4	100
	10 pole	CA727/10	10	CA727/10	10	CA727/10	10

Current Bars	2 pole	CA703/1	100	CA703/1	100	CA703/1	100
	3 pole	CA704/1	100	CA704/1	100	CA704/1	100
	4 pole	CA705/1	100	CA705/1	100	CA705/1	100
	10 pole	CA732/10	100	CA732/10	100	CA732/10	100
	10 pole (breakable)	CA732/10-A	100	CA732/10-A	100	CA732/10-A	100
	100 pole	CA732/100	10	CA732/100	10	CA732/100	10

Shorting Sleeve & Screw	CA607/S/Q	100	CA607/S/Q	100	CA607/S/Q	100
-------------------------	-----------	-----	-----------	-----	-----------	-----

Marking Tags	MT2	100	MT2	100	MT2	100
--------------	-----	-----	-----	-----	-----	-----

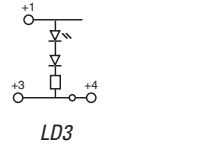
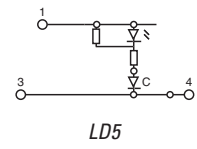
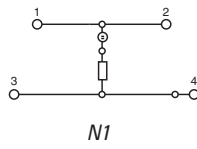

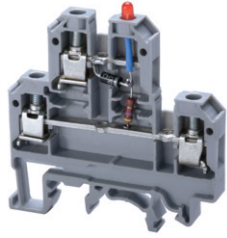

* Add required voltage to part number as a suffix i.e. CDL4U(E)LD5/110 is for 110V.

CDL4U(E)LD4*



AC/ DC voltage indicator with LED



6 mm		
54 x 55.5 mm		
24V~, 48 V~		
9 mm		
Polyamide 6.6		
 US 60947-7-1	 60947-7-1	 US E220514
22-10 AWG	0.2-4 sq.mm	22-10 AWG
300 V	500 V	600 V
25 A	32 A	35 A
7 lb-in	0.5 Nm	7 lb-in

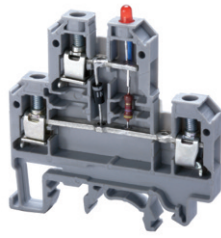

CDL4U(E)LD1/LD2



DC voltage indicator with LED



6 mm		
54 x 55.5 mm		
24 V~		
9 mm		
Polyamide 6.6		
 US 60947-7-1	 60947-7-1	 US E220514
22-10 AWG	0.2-4 sq.mm	22-10 AWG
300 V	500 V	600 V
25 A	32 A	35 A
7 lb-in	0.5 Nm	7 lb-in

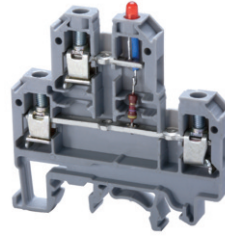

CDL4U(E)L1/L2*



DC voltage indicator with LED



6 mm		
54 x 55.5 mm		
6 V~, 24 V~, 60 V~		
9 mm		
Polyamide 6.6		
 US 60947-7-1	 60947-7-1	 US E220514
22-10 AWG	0.2-4 sq.mm	22-10 AWG
300 V	500 V	600 V
25 A	32 A	35 A
7 lb-in	0.5 Nm	7 lb-in



CDL4U(O)



Electronic Component Carrier

6 mm		
54 x 55.5 mm		
9 mm		
Polyamide 6.6		
 US 60947-7-1	 60947-7-1	 US E220514
22-10 AWG	0.2-4 sq.mm	22-10 AWG
300 V	500 V	600 V
25 A	32 A	35 A
7 lb-in	0.5 Nm	7 lb-in



Cat. No.	Std. Pk.
CDL4U(E)LD4*	50
EPCDL4U	50
CA702 CA802	50 50
CA727/2	100
CA727/3	100
CA727/4	100
CA727/10	10
CA703/1	100
CA704/1	100
CA705/1	100
CA732/10	100
CA732/10-A	100
CA732/100	10
CA607/S/Q	100
MT2	100

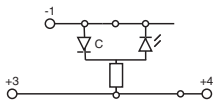

Cat. No.	Std. Pk.
CDL4U(E)LD1 CDL4U(E)LD2	50 50
EPCDL4U	50
CA702 CA802	50 50
CA727/2	100
CA727/3	100
CA727/4	100
CA727/10	10
CA703/1	100
CA704/1	100
CA705/1	100
CA732/10	100
CA732/10-A	100
CA732/100	10
CA607/S/Q	100
MT2	100

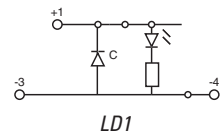

Cat. No.	Std. Pk.
CDL4U(E)L1* CDL4U(E)L2*	50 50
EPCDL4U	50
CA702 CA802	50 50
CA727/2	100
CA727/3	100
CA727/4	100
CA727/10	10
CA703/1	100
CA704/1	100
CA705/1	100
CA732/10	100
CA732/10-A	100
CA732/100	10
CA607/S/Q	100
MT2	100

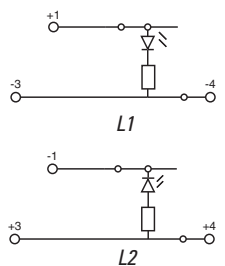

Cat. No.	Std. Pk.
CDL4U(O)	100
EPCDL4U	50
CA702 CA802	50 50
CA727/2	100
CA727/3	100
CA727/4	100
CA727/10	10
CA703/1	100
CA704/1	100
CA705/1	100
CA732/10	100
CA732/10-A	100
CA732/100	10
CA607/S/Q	100
MT2	100

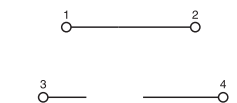

* Add required voltage to part number as a suffix i.e. CDL4U(E)LD5/110 is for 110V.

Surge Suppressor

In applications where circuit protection against transient overvoltage is required, Altech Surge Suppressor Terminal Blocks with built-in electronic components are recommended.

These terminals are designed to protect a single line against a longitudinal (line / earth) surge, thereby protecting distribution and inputs.

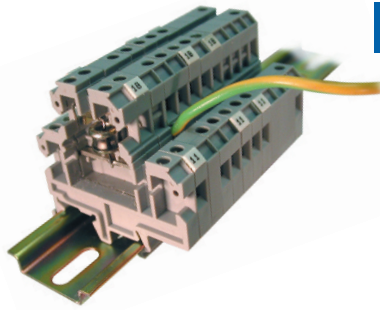

CDL4U(E)LA

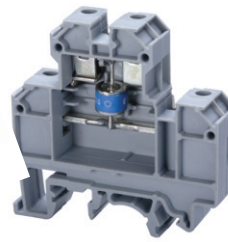

Lightning Arrestor

CDL4U(E)3LA

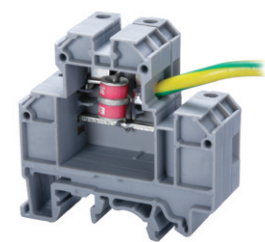

3 Pole Lightning Arrestor

Terminal Width	12 mm	18 mm
Height x Length	54 x 55.5 mm	54 x 55.5 mm
Stripping Length	9 mm	9 mm
Insulation Material	Polyamide 6.6	Polyamide 6.6
Type of Connection	4 screw clamps	4 screw clamps
Wire Range	22-10 AWG	22-10 AWG
Voltage Rating	75, 90, 230, 600, 1000 V DC	90, 230, 350, 600 V DC
Nominal Discharge Current	20 KA (8/20µs)	10 KA (8/20µs)
Peak Current	-	-
Response Time	100 ns	100 ns
Nominal Current	10A	5A
Capacitance	<1.5 pf	<1.0 pf
Application	For coarse line protection of measuring, distributing or data communication interfaces.	For simultaneous protection of lines against transversal (line/line) and longitudinal (line/earth) surge.

Terminal Block

Cat. No.	Std. Pk.	Cat. No.	Std. Pk.
CDL4U(E)LA75V	20	CDL4U(E)3LA90V	20
CDL4U(E)LA90V	20	CDL4U(E)3LA230V	20
CDL4U(E)LA230V	20	CDL4U(E)3LA350V	20
CDL4U(E)LA600V	20	CDL4U(E)3LA600V	20
CDL4U(E)LA1000V	20		

End Plate 	EPCDL4U	50	EPCDL4U	50
---	---------	----	---------	----

DIN Rail
for ordering information
refer to page 80-81



End Stop 	CA702 CA802	50 50	CA702 CA802	50 50
--	----------------	----------	----------------	----------



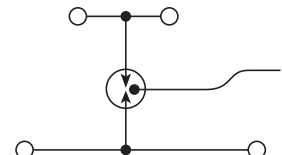
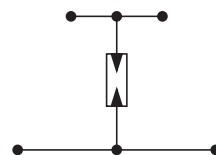





Marking Tags 	MT2	100	MT2	100
--	-----	-----	-----	-----



COLOR BLOCKS
(other than standard grey)

When ordering please add color suffix to Cat. No.

Example for color Red: **Cat.No./R**

Color	Ordering Suffix	
Red	R	
Yellow	Y	
Blue	BU	
Green	G	
<i>Consult Altech for availability.</i>		
Orange	O	
Beige	BG	
Dark Brown	DB	
Black	BL	
White	W	

CDL4U(E)MOV¹



MOV

12 mm

54 x 55.5 mm

9 mm

Polyamide 6.6

4 screw clamps

22-10 AWG

30, 60, 75, 130, 275,
460, 510, 625, 680 V AC

-

2kA-6.5kA (8/20µs)

<25ns

-

100-20,000 pf

For protection from voltage surge, spikes

CDL4U(E)RC

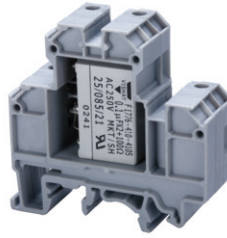

RC Circuit

18 mm

54 x 55.5 mm

9 mm

Polyamide 6.6

4 screw clamps

22-10 AWG

250 V AC / 630 V DC

20A

-

-

-

0.1 µf or 0.22 µf

For protection of DC solenoid valves and contactors

CDL4U(E)SD

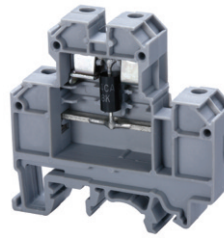

Suppressor Diode

12 mm

54 x 55.5 mm

9 mm

Polyamide 6.6

4 screw clamps

22-10 AWG

12-48V DC / 12-160V AC**

1.5 KA

-

1 ns DC / 5 ns AC

-

-

For fine protection of data interfaces, sensors, contacts, etc.

Cat. No. **Std. Pk.**

CDL4U(E)MOV30V 20
 CDL4U(E)MOV60V 20
 CDL4U(E)MOV75V 20
 CDL4U(E)MOV130V 20
 CDL4U(E)MOV275V 20
 CDL4U(E)MOV460V 20
 CDL4U(E)MOV510V 20
 CDL4U(E)MOV625V 20
 CDL4U(E)MOV680V 20

EPCDL4U 50



CA702 50
 CA802 50

MT2 100

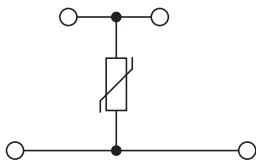

Cat. No. **Std. Pk.**

CDL4U(E)RC0.1 20
 CDL4U(E)RC0.22 20

EPCDL4U 50



CA702 50
 CA802 50

MT2 100

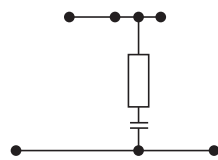

Cat. No. **Std. Pk.**

CDL4U(E)SDUA15V 20
 CDL4U(E)SDUA24V 20
 CDL4U(E)SDUA48V 20
 CDL4U(E)SDUK15V 20
 CDL4U(E)SDUK24V 20
 CDL4U(E)SDUK48V 20
 CDL4U(E)SDB15V 20
 CDL4U(E)SDB24V 20
 CDL4U(E)SDB48V 20
 CDL4U(E)SDB160V 20

EPCDL4U 50



CA702 50
 CA802 50

MT2 100

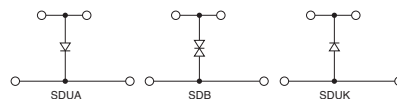

Note:
 CDL4U(E)SDU - For D.C. Application
 CDL4U(E)SDB - For A.C. Application
 A - Anode
 K - Cathode

¹ A fuse block is recommended to protect MOV terminals by disconnecting the faulted varistor. See pages 21-25 for fuse blocks.
 ** Phase to Phase / Phase to ground.

Stud Type Block

Altech DIN rail mounting Stud Type Terminal Blocks are preferred for the connections that are subjected to very severe vibrations.

The wire is crimped to a ring / fork type lug and is screwed on to the flat current bar in terminal.

Jumpering can be achieved with the aid of external jumpers. The jumpers are insulated to make them shock proof. The terminal blocks have marker holding recess to accommodate marking tags.

It is recommended to use protective covers in transparent plastic because assemblies of these terminals blocks are not fully covered.

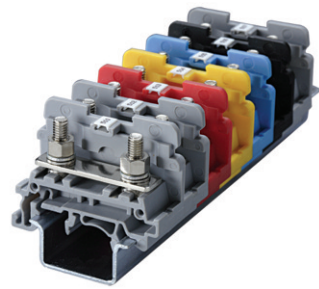

	CSTSN4U	CSTSN5U
--	---------	---------

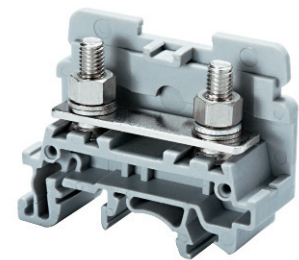
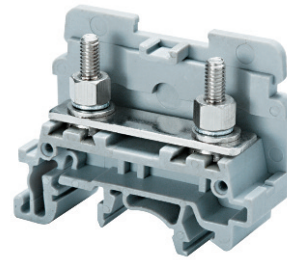

Terminal Width	17 mm			17 mm		
Height x Length	39.5 x 50 mm			39.5 x 50 mm		
Stripping Length	12 mm			12 mm		
Insulation Material	Polyamide 6.6			Polyamide 6.6		
Type of Connection	2 screw connection for M4 ring/fork lugs			2 screw connection for M5 ring/fork lugs		
Approvals	C US	60947-7-1	E220514 US	C US	60947-7-1	E220514 US
Wire Range	22-6 AWG	1.5-10 sq.mm	22-6 AWG	22-4 AWG	1.5-16 sq.mm	22-4 AWG
Voltage Rating	600 V	1000 V	600 V	600 V	1000 V	600 V
Current Rating	65 A	57 A	65 A	80 A	76 A	80 A
Torque	14 lb-in	1.2 Nm	14 lb-in	25 lb-in	2.0 Nm	25 lb-in
Other Approvals						

	Cat. No.	Std. Pk.	Cat. No.	Std. Pk.
Terminal Block	CSTSN4U	100	CSTSN5U	100
End Plate	EPCSTSN5U	50	EPCSTSN5U	50
DIN Rail for ordering information refer to pages 90-91				
End Stop for ordering information refer to page 92	CA702	50	CA702	50
	CA802	50	CA802	50
Protective Cover for covering 2 Terminal	CSTSPC1	100	CSTSPC1	100
	CSTSPC1-1	100	CSTSPC1-1	100
Protective Cover in Length	CSTSPC1-2	10	CSTSPC1-2	10
	CSTSPC1-3	10	CSTSPC1-3	10
	CSTSPC1-4	10	CSTSPC1-4	10
Insulated Removable Jumpers	CA514/1-2	100	CA514/1-2	100
	CA514/1-3	50	CA514/1-3	50
	CA514/1-4	50	CA514/1-4	50
Insulated Permanent Jumpers	CA514/3-2	100	CA514/3-2	100
	CA514/3-3	50	CA514/3-3	50
	CA514/3-4	50	CA514/3-4	50
Marking Tags	MT2B4	100	MT2B4	100

COLOR BLOCKS
(other than standard grey)

When ordering please add color suffix to Cat. No.

Example for color Red: Cat.No./R

Color	Ordering Suffix	
Red	R	
Yellow	Y	
Blue	BU	
Green	G	
<i>Consult Altech for availability.</i>		
Orange	O	
Beige	BG	
Dark Brown	DB	
Black	BL	
White	W	

CSTSN6U

CSTSB4U

CSTSB5U

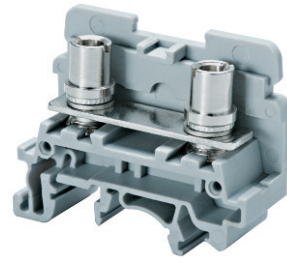
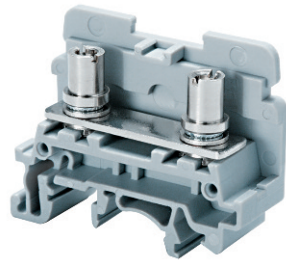
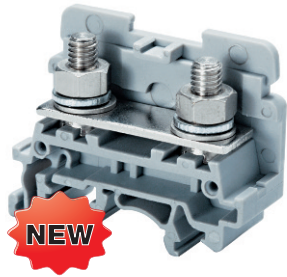

17 mm

17 mm

17 mm

39.5 x 50 mm

39.5 x 50 mm

39.5 x 50 mm

12 mm

12 mm

12 mm

Polyamide 6.6

Polyamide 6.6

Polyamide 6.6

2 screw connection for M5 ring/fork lugs

2 screw connection for M4 ring/fork lugs

2 screw connection for M5 ring/fork lugs

C US	60947-7-1	C US E220514
22-2 AWG	1.5-35 sq.mm	22-2 AWG
600 V	1000 V	600 V
125 A	125 A	125 A
25 lb-in	3.0 Nm	25 lb-in

C US	60947-7-1	C US E220514
22-6 AWG	1.5-10 sq.mm	22-6 AWG
600 V	1000 V	600 V
65 A	57 A	65 A
14 lb-in	1.2 Nm	14 lb-in

C US	60947-7-1	C US E220514
22-4 AWG	1.5-16 sq.mm	22-4 AWG
600 V	1000 V	600 V
80 A	76 A	80 A
25 lb-in	2.0 Nm	25 lb-in



Cat. No.	Std. Pk.
CSTSN6U	100
EPCSTSN5U	50

Cat. No.	Std. Pk.
CSTSB4U	100
EPCSTN5U	50

Cat. No.	Std. Pk.
CSTSB5U	100
EPCSTN5U	50



CA702	50
CA802	50

CA702	50
CA802	50

CA702	50
CA802	50

CSTSPC1	100
CSTSPC1-1	100

CSTSPC1	100
CSTSPC1-1	100

CSTSPC1	100
CSTSPC1-1	100

CSTSPC1-2	10
CSTSPC1-3	10
CSTSPC1-4	10

CSTSPC1-2	10
CSTSPC1-3	10
CSTSPC1-4	10

CSTSPC1-2	10
CSTSPC1-3	10
CSTSPC1-4	10

CA514/1-2	100
CA514/1-3	50
CA514/1-4	50

CA514/1-2	100
CA514/1-3	50
CA514/1-4	50

CA514/1-2	100
CA514/1-3	50
CA514/1-4	50

CA514/3-2	100
CA514/3-3	50
CA514/3-4	50

CA514/3-2	100
CA514/3-3	50
CA514/3-4	50

CA514/3-2	100
CA514/3-3	50
CA514/3-4	50

MT2B4	100
-------	-----

MT2B4	100
-------	-----

MT2B4	100
-------	-----

Hinge Type Stud Block

STH Series Terminal Blocks are preferred for application where the connections are subjected to severe vibration. The wire is crimped to a ring / fork lug and is screwed on to the flat current bar of the Terminal Block. The hinged carrier should be lifted to insert the lugs and then fastened to complete the connection.

By virtue of the hinged design, the Terminal Blocks apart from shrouding the live parts, providing IP 20 (Finger Safe) protection, save considerable time in wiring.

Two Lugs can be connected to the Terminal, without sacrificing the safety of the Terminal Block.

STH4DT Disconnect & Test Terminal Block is used for measuring, control and regulatory circuits. They provide a clear functional advantage for devices having utility instruments and associated transformers.

Socket Headed Screws act as test monitoring point on either side of the Terminal Block. Disconnection is achieved by means of a slide link operated with a Screw Driver.

STH4DTSH Terminal Block has 2 STH4DT Terminal Block shorted to achieve switchable cross connection (on one side).

Note: The disconnecting device is not suitable for interrupting load. The supply must be switched off before operating the slide link / moving the hinged carrier.

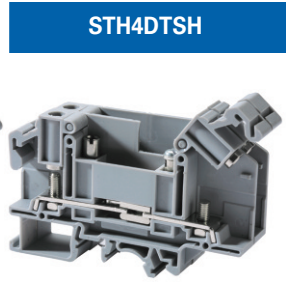
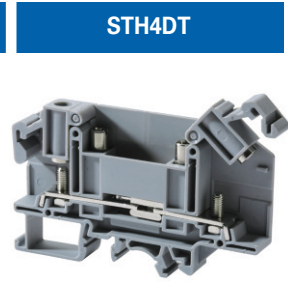
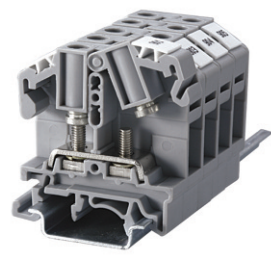

	STH4			STH4DT			STH4DTSH		
Terminal Width	11 mm			11 mm			22 mm		
Height x Length	50.5 x 46 mm			50.5 x 86 mm			50.5 x 86 mm		
Stripping Length	10 mm			10 mm			10 mm		
Insulation Material	Polyamide 6.6			Polyamide 6.6			Polyamide 6.6		
Type of Connection	2 stud flat connection			2 stud flat connection			2 stud flat connection		
Stud Size / Operated by	M4 / Screwdriver			M4 / Screwdriver			M4 / Screwdriver		
Approvals									
Wire Range	22-8 AWG	1.5-6 sq.mm	22-8 AWG	22-8 AWG	1.5-6 sq.mm	22-8 AWG	22-8 AWG	1.5-6 sq.mm	22-8 AWG
Voltage Rating	600 V	1000 V	600 V	600 V	1000 V	600 V	600 V	1000 V	300 V
Current Rating	50 A	41 A	50 A	35 A	41 A	35 A	35 A	34 A	25 A
Torque	14 lb-in	1.2 Nm	14 lb-in	14 lb-in	1.2 Nm	14 lb-in	14 lb-in	1.2 Nm	14 lb-in
Other Approvals									

	STH4		STH4DT		STH4DTSH		
	Cat. No.	Std. Pk.	Cat. No.	Std. Pk.	Cat. No.	Std. Pk.	
Terminal Block	STH4	100	STH4DT	100	STH4DTSH	100	
End Plate	EPSTH4	50	EPSTH4DT	50	EPSTH4DT	50	
DIN Rail for ordering information refer to pages 90-91							
End Stop for ordering info. refer to page 92	CA702 CA802	100 50	CA702 CA802	100 50	CA702 CA802	100 50	
Removable Shorting Link	2 way 3 way 4 way	CA512/13-2 CA512/13-3 CA512/13-4	100 50 50	CA512/13-2 CA512/13-3 CA512/13-4	100 50 50	CA512/13-2 CA512/13-3 CA512/13-4	100 50 50
Insulated Removable Shorting Link	2 way 3 way 4 way	CA514/13-2 CA514/13-3 CA514/13-4	100 50 50	CA514/13-2 CA514/13-3 CA514/13-4	100 50 50	CA514/13-2 CA514/13-3 CA514/13-4	100 50 50
Permanent Shorting Link	2 way 3 way 4 way	CA512/14-2 CA512/14-3 CA512/14-4	100 50 50	CA512/14-2 CA512/14-3 CA512/14-4	100 50 50	CA512/14-2 CA512/14-3 CA512/14-4	100 50 50
Insulated Permanent Jumpers	2 way 3 way 4 way	CA514/14-2 CA514/14-3 CA514/14-4	100 50 50	CA514/14-2 CA514/14-3 CA514/14-4	100 50 50	CA514/14-2 CA514/14-3 CA514/14-4	100 50 50
Marking Tags	MT10	100	MT10	100	MT10	100	





PTB series Terminal Blocks are preferred for applications using wires of large cross section. The Wire is crimped to a ring / fork lug and is screwed on to the flat current bar of the Terminal Block. Specially designed Mounting Feet hold the Terminal Block rigidly on to the Mounting Rail.

Two Lugs of 35 sq.mm can be connected to the Terminal Block, without sacrificing the safety of the Terminal Block. Hinged Protective Cover makes the Terminal Block shock proof (finger safe) and has marker recess to accept marking tags.

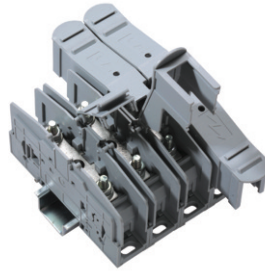
The Terminal Blocks can be stacked together by pressing the adjacent Terminal Blocks firmly. In PTB35SH series Terminal Blocks, adjacent terminals can be shorted by removing a thin wall partition and using 2/3/4 way shorting link.

* Optional Marker Holder can be used for installing marking tags on the Terminal Blocks without protective covers.

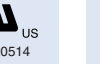



Terminal Width	25 mm
Height x Length	73.6 x 169 mm
Stripping Length	18 mm / M6
Insulation Material	Polyamide 6.6
Type of Connection	2 bolts for connection
Approvals	  
Wire Range	8-2 AWG / 1.5-50 mm²
Voltage Rating	600 V / 1000 V
Current Rating	115 A / 150 A
Torque	27 lb-in / 3.0 Nm
Other Approvals	 

Terminal Block

DIN Rail for ordering information refer to pages 90-91

End Stop for ordering information refer to page 92

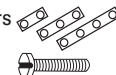
Bolt Size

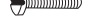
Current Bars  2 pole
 3 pole
 4 pole

Marking Tags 

Marking Tag Holder

PTB35/50 / PTB35/50SH

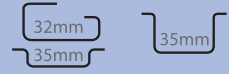

Cat. No.	PTB35/50	PTB35/50SH
Std. Pk.	10	10
		
CA102	50	50
CA202	50	50
M6	-	-
CA703/9	10	10
CA704/9	10	10
CA705/9	10	10
MT9	100	100
MHPTB35*		

PTB70/95 / PTB70/95SH

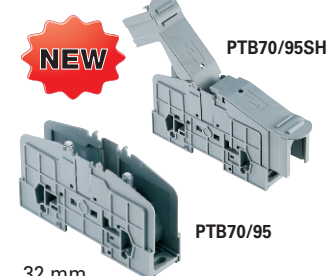

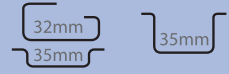
Cat. No.	PTB70/95	PTB70/95SH
Std. Pk.	10	10
		
CA102	50	50
CA202	50	50
M8	-	-
CA703/11	10	10
CA704/11	10	10
CA705/11	10	10
MT9	100	100
MHPTB70*		



Cat. No. Std. Pk.

Cat. No. Std. Pk.

PTB35/50 PTB35/50SH

PTB70/95 PTB70/95SH

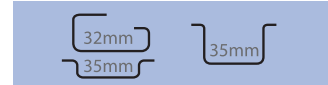
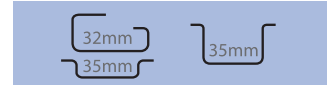

CA102 50
CA202 50

CA102 50
CA202 50

M6 -

M8 -

CA703/9 10
CA704/9 10
CA705/9 10

CA703/11 10
CA704/11 10
CA705/11 10

MT9 100

MT9 100

MHPTB35*

MHPTB70*

