

Fixed PCB Blocks

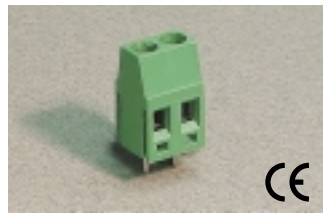

Pin Spacing: 5.00mm
 Orientation: Vertical
 Clamp Type: Screw Cage
 Design: Modular



MVE-25

ELECTRICAL

	Current	Voltage	Wire Range
	15A ^①	300V	30-14AWG
	16A	450V	2.5mm ² Stranded 4.0mm ² Solid

INSTALLATION DATA

Screw Size	M3	PCB Hole Size	1.3mm
Torque	0.5Nm (4.5 lbf-in.)	Stripping Lgth.	7.1mm

MATERIAL

Body	PA6.8	Screw	Galvanized Steel
Flammability Class	UL94V-0	Terminal	Tin-Plated Brass
Temperature Limit	105°C UL 125°C IEC	Clamp	Nickel Brass
Color	Green		

No. Poles	Cat. #	Length (B) (mm)	Std. Pk.
2	MVE-252	10.0	100
3	MVE-253	15.0	100
4	MVE-254	20.0	50
5	MVE-255	25.0	50
6	MVE-256	30.0	50
7	MVE-257	35.0	50
8	MVE-258	40.0	50
9	MVE-259	45.0	50
10	MVE-2510	50.0	50
11	MVE-2511	55.0	50
12	MVE-2512	60.0	50
13	MVE-2513	65.0	20
14	MVE-2514	70.0	20
15	MVE-2515	75.0	20
16	MVE-2516	80.0	20
17	MVE-2517	85.0	20
18	MVE-2518	90.0	20
19	MVE-2519	95.0	20
20	MVE-2520	100.0	20
21	MVE-2521	105.0	20
22	MVE-2522	110.0	20
23	MVE-2523	115.0	20
24	MVE-2524	120.0	20

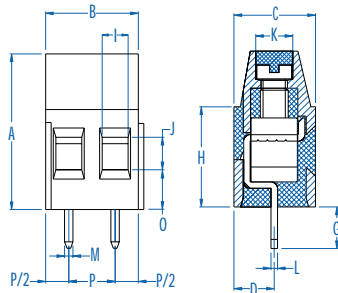

Dimensions

A	16.80 mm	I	2.80 mm
B	10.00 mm	J	2.80 mm
C	8.90 mm	K	Ø3.80 mm
D	4.35 mm	L	0.70 mm
E	-	M	0.90 mm
F	-	N	-
G	4.50 mm	O	4.60 mm
H	10.80 mm	P	5.00 mm

① 16A Factory Wiring - UL

Pin Spacing: 5.00mm
 Orientation: Horizontal
 Clamp Type: Tubular Screw with Wire Protector
 Design: Modular



MHE-13

ELECTRICAL

	Current	Voltage	Wire Range
	16A	250V	22-16AWG

INSTALLATION DATA

Screw Size	M2.6	PCB Hole Size	1.3mm
Torque	0.4Nm (3.6 lbf-in.)	Stripping Lgth.	5.6mm

MATERIAL

Body	Glass-Filled Polyester	Screw	Galvanized Steel
Flammability Class	UL94V-0	Terminal	Tin-Plated Brass
Temperature Limit	130°C UL 125°C IEC	Wire Protector	CuSn6
Color	Black		

No. Poles	Cat. #	Length (B) (mm)	Std. Pk.
2	MHE-132	10.0	100
3	MHE-133	15.0	100
4	MHE-134	20.0	50
5	MHE-135	25.0	50
6	MHE-136	30.0	50
7	MHE-137	35.0	50
8	MHE-138	40.0	50
9	MHE-139	45.0	50
10	MHE-1310	50.0	50
11	MHE-1311	55.0	50
12	MHE-1312	60.0	50
13	MHE-1313	65.0	20
14	MHE-1314	70.0	20
15	MHE-1315	75.0	20
16	MHE-1316	80.0	20
17	MHE-1317	85.0	20
18	MHE-1318	90.0	20
19	MHE-1319	95.0	20
20	MHE-1320	100.0	20
21	MHE-1321	105.0	20
22	MHE-1322	110.0	20
23	MHE-1323	115.0	20
24	MHE-1324	120.0	20

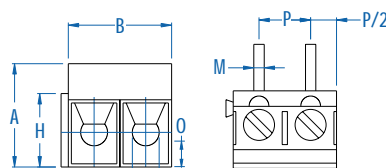

Dimensions

A	10.00 mm	I	-
B	10.00 mm	J	Ø2.60 mm
C	7.50 mm	K	Ø3.50 mm
D	2.70 mm	L	-
E	-	M	Ø1.00 mm
F	-	N	-
G	3.70 mm	O	1.40 mm
H	7.10 mm	P	5.00 mm

Fixed PCB Blocks

Pin Spacing: 5.00mm
 Orientation: Horizontal
 Clamp Type: Tubular Screw with Wire Protector
 Design: Modular



MHE-16

ELECTRICAL

	Current	Voltage	Wire Range
	16A	250V	22-14AWG

INSTALLATION DATA

Screw Size	M3	PCB Hole Size	1.3mm
Torque	0.5Nm (4.5 lbf-in.)	Stripping Lgth.	5.8mm

MATERIAL

Body	Glass-Filled Polyester	Screw	Galvanized Steel
Flammability Class	UL94V-0	Terminal	Tin-Plated Brass
Temperature Limit	130°C UL 125°C IEC	Wire Protector	CuSn6
Color	Black		

No. Poles	Cat. #	Length (B) (mm)	Std. Pk.
2	MHE-162	10.0	100
3	MHE-163	15.0	100
4	MHE-164	20.0	50
5	MHE-165	25.0	50
6	MHE-166	30.0	50
7	MHE-167	35.0	50
8	MHE-168	40.0	50
9	MHE-169	45.0	50
10	MHE-1610	50.0	50
11	MHE-1611	55.0	50
12	MHE-1612	60.0	50
13	MHE-1613	65.0	20
14	MHE-1614	70.0	20
15	MHE-1615	75.0	20
16	MHE-1616	80.0	20
17	MHE-1617	85.0	20
18	MHE-1618	90.0	20
19	MHE-1619	95.0	20
20	MHE-1620	100.0	20
21	MHE-1621	105.0	20
22	MHE-1622	110.0	20
23	MHE-1623	115.0	20
24	MHE-1624	120.0	20

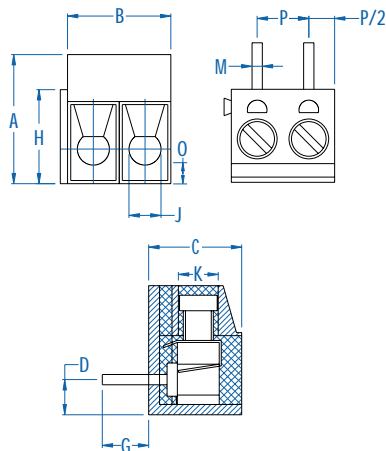

Dimensions

A	12.50 mm	I	—
B	10.00 mm	J	Ø3.10 mm
C	9.00 mm	K	Ø3.95 mm
D	3.40 mm	L	—
E	—	M	Ø1.00 mm
F	—	N	—
G	4.50 mm	O	2.00 mm
H	8.80 mm	P	5.00 mm

Pin Spacing: 5.00mm
 Orientation: Horizontal
 Clamp Type: Screw Cage
 Design: Modular



MH-15

ELECTRICAL

	Current	Voltage	Wire Range
	10A	300V	30-16AWG
	13.5A	250V	1.5mm ² Stranded 2.5mm ² Solid

INSTALLATION DATA

Screw Size	M3	PCB Hole Size	1.3mm
Torque	0.5Nm (4.5 lbf-in.)	Stripping Lgth.	6.7mm

MATERIAL

Body	PA6.8	Screw	Galvanized Steel
Flammability Class	UL94V-0	Terminal	Tin-Plated Brass
Temperature Limit	105°C UL 125°C IEC	Clamp	Nickeled Brass
Color	Green		

No. Poles	Cat. #	Length (B) (mm)	Std. Pk.
2	MH-152	10.0	100
3	MH-153	15.0	100
4	MH-154	20.0	50
5	MH-155	25.0	50
6	MH-156	30.0	50
7	MH-157	35.0	50
8	MH-158	40.0	50
9	MH-159	45.0	50
10	MH-1510	50.0	50
11	MH-1511	55.0	50
12	MH-1512	60.0	50
13	MH-1513	65.0	20
14	MH-1514	70.0	20
15	MH-1515	75.0	20
16	MH-1516	80.0	20
17	MH-1517	85.0	20
18	MH-1518	90.0	20
19	MH-1519	95.0	20
20	MH-1520	100.0	20
21	MH-1521	105.0	20
22	MH-1522	110.0	20
23	MH-1523	115.0	20
24	MH-1524	120.0	20

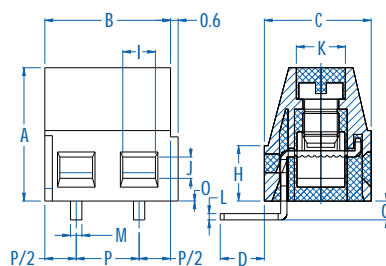

Dimensions

A	10.60 mm	I	2.60 mm
B	10.00 mm	J	1.70 mm
C	8.50 mm	K	Ø3.90 mm
D	3.70 mm	L	0.50 mm
E	—	M	0.90 mm
F	—	N	—
G	1.50 mm	O	1.80 mm
H	4.40 mm	P	5.00 mm

Fixed PCB Blocks



Pin Spacing: 5.00mm
 Orientation: Horizontal
 Clamp Type: Screw Cage
 Design: Modular

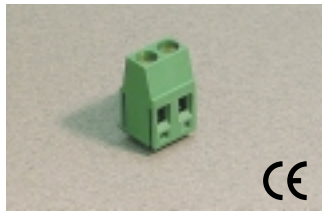

MHE-25

ELECTRICAL

	Current	Voltage	Wire Range
	15A ^①	300V	30-14AWG
	16A	450V	2.5mm ² Stranded 4.0mm ² Solid

INSTALLATION DATA

Screw Size	M3	PCB Hole Size	1.3mm
Torque	0.5Nm (4.5 lbf-in.)	Stripping Lgth.	7.1mm

MATERIAL

Body	PA6.8	Screw	Galvanized Steel
Flammability Class	UL94V-0	Terminal	Tin-Plated Brass
Temperature Limit	105°C UL 125°C IEC	Clamp	Nickeled Brass
Color	Green		

No. Poles	Cat. #	Length (B) (mm)	Std. Pk.
2	MHE-252	10.0	100
3	MHE-253	15.0	100
4	MHE-254	20.0	50
5	MHE-255	25.0	50
6	MHE-256	30.0	50
7	MHE-257	35.0	50
8	MHE-258	40.0	50
9	MHE-259	45.0	50
10	MHE-2510	50.0	50
11	MHE-2511	55.0	50
12	MHE-2512	60.0	50
13	MHE-2513	65.0	20
14	MHE-2514	70.0	20
15	MHE-2515	75.0	20
16	MHE-2516	80.0	20
17	MHE-2517	85.0	20
18	MHE-2518	90.0	20
19	MHE-2519	95.0	20
20	MHE-2520	100.0	20
21	MHE-2521	105.0	20
22	MHE-2522	110.0	20
23	MHE-2523	115.0	20
24	MHE-2524	120.0	20

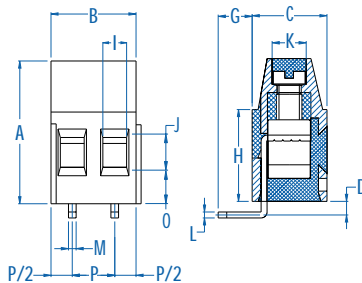

Dimensions

A	16.80 mm	I	2.80 mm
B	10.00 mm	J	2.80 mm
C	8.90 mm	K	Ø3.80 mm
D	1.40 mm	L	0.70 mm
E	-	M	0.90 mm
F	-	N	-
G	4.00 mm	O	4.60 mm
H	10.80 mm	P	5.00 mm

① 16A Factory Wiring - UL

Pin Spacing: 5.00mm
 Orientation: Reverse Horizontal
 Clamp Type: Screw Cage
 Design: Modular

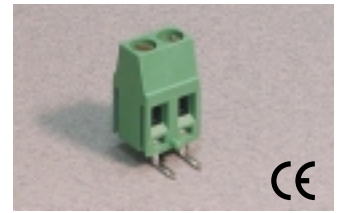

MHR-25

ELECTRICAL

	Current	Voltage	Wire Range
	15A ^①	300V	30-14AWG
	16A	250V	2.5mm ² Stranded 4.0mm ² Solid

INSTALLATION DATA

Screw Size	M3	PCB Hole Size	1.3mm
Torque	0.5Nm (4.5 lbf-in.)	Stripping Lgth.	7.1mm

MATERIAL

Body	PA6.8	Screw	Galvanized Steel
Flammability Class	UL94V-0	Terminal	Tin-Plated Brass
Temperature Limit	105°C UL 125°C IEC	Clamp	Nickeled Brass
Color	Green		

No. Poles	Cat. #	Length (B) (mm)	Std. Pk.
2	MHR-252	10.0	100
3	MHR-253	15.0	100
4	MHR-254	20.0	50
5	MHR-255	25.0	50
6	MHR-256	30.0	50
7	MHR-257	35.0	50
8	MHR-258	40.0	50
9	MHR-259	45.0	50
10	MHR-2510	50.0	50
11	MHR-2511	55.0	50
12	MHR-2512	60.0	50
13	MHR-2513	65.0	20
14	MHR-2514	70.0	20
15	MHR-2515	75.0	20
16	MHR-2516	80.0	20
17	MHR-2517	85.0	20
18	MHR-2518	90.0	20
19	MHR-2519	95.0	20
20	MHR-2520	100.0	20
21	MHR-2521	105.0	20
22	MHR-2522	110.0	20
23	MHR-2523	115.0	20
24	MHR-2524	120.0	20

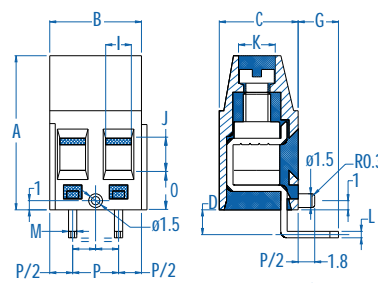

Dimensions

A	16.80 mm	I	2.80 mm
B	10.00 mm	J	2.80 mm
C	8.90 mm	K	Ø3.80 mm
D	2.30 mm	L	0.70 mm
E	-	M	0.90 mm
F	-	N	-
G	4.00 mm	O	4.60 mm
H	-	P	5.00 mm

① 16A Factory Wiring - UL

Fixed PCB Blocks

Pin Spacing: 5.00mm
 Orientation: 45°
 Clamp Type: Screw Cage
 Design: Modular

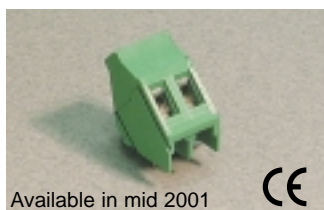

Available in mid 2001

MI-25(5.00)

ELECTRICAL

	Current	Voltage	Wire Range
US Pending	15A	300V	30-14AWG
	16A	450V	2.5mm ² Stranded 4.0mm ² Solid

INSTALLATION DATA

Screw Size	M3	PCB Hole Size	1.3mm
Torque	0.5Nm (4.5 lbf-in.)	Stripping Lgth.	8.3mm

MATERIAL

Body	PA6.8	Screw	Galvanized Steel
Flammability Class	UL94V-0	Terminal	Tin-Plated Brass
Temperature Limit	105°C UL 125°C IEC	Clamp	Nickel Brass
Color	Green		

No. Poles	Cat. #	Length (B) (mm)	Std. Pk.
2	MI-252 (5.00)	10.0	100
3	MI-253 (5.00)	15.0	100
4	MI-254 (5.00)	20.0	50
5	MI-255 (5.00)	25.0	50
6	MI-256 (5.00)	30.0	50
7	MI-257 (5.00)	35.0	50
8	MI-258 (5.00)	40.0	50
9	MI-259 (5.00)	45.0	50
10	MI-2510 (5.00)	50.0	50
11	MI-2511 (5.00)	55.0	50
12	MI-2512 (5.00)	60.0	50
13	MI-2513 (5.00)	65.0	20
14	MI-2514 (5.00)	70.0	20
15	MI-2515 (5.00)	75.0	20
16	MI-2516 (5.00)	80.0	20
17	MI-2517 (5.00)	85.0	20
18	MI-2518 (5.00)	90.0	20
19	MI-2519 (5.00)	95.0	20
20	MI-2520 (5.00)	100.0	20
21	MI-2521 (5.00)	105.0	20
22	MI-2522 (5.00)	110.0	20
23	MI-2523 (5.00)	115.0	20
24	MI-2524 (5.00)	120.0	20

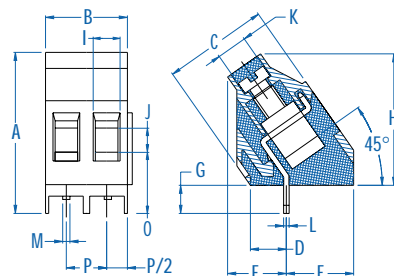

Dimensions

A	21.10 mm	I	2.80 mm
B	10.00 mm	J	2.80 mm
C	13.00 mm	K	Ø3.80 mm
D	4.95 mm	L	0.70 mm
E	7.00 mm	M	0.90 mm
F	10.10 mm	N	-
G	4.00 mm	O	8.50 mm
H	16.30 mm	P	5.00 mm

Pin Spacing: 5.08mm
 Orientation: Vertical
 Clamp Type: Box with Wire Protector
 Design: Modular



Available in mid 2001

MBES-15

ELECTRICAL

	Current	Voltage	Wire Range
US Pending	10A	300V	30-16AWG
	17.5A	250V	1.5mm ² Stranded 2.5mm ² Solid

INSTALLATION DATA

Screw Size	M2.5	PCB Hole Size	1.5mm
Torque	0.4Nm (3.6 lbf-in.)	Stripping Lgth.	6.7mm

MATERIAL

Body	PA6.8	Screw	Galvanized Steel
Flammability Class	UL94V-0	Terminal	Tin-Plated Brass
Temperature Limit	105°C UL 125°C IEC	Wire Protector	Tin-Plated Bronze
Color	Green		

No. Poles	Cat. #	Length (B) (mm)	Std. Pk.
2	MBES-152	10.2	100
3	MBES-153	15.2	100
4	MBES-154	20.3	50
5	MBES-155	25.4	50
6	MBES-156	30.5	50
7	MBES-157	35.6	50
8	MBES-158	40.6	50
9	MBES-159	45.7	50
10	MBES-1510	50.8	50
11	MBES-1511	55.9	50
12	MBES-1512	61.0	50
13	MBES-1513	66.0	20
14	MBES-1514	71.1	20
15	MBES-1515	76.2	20
16	MBES-1516	81.3	20
17	MBES-1517	86.4	20
18	MBES-1518	91.4	20
19	MBES-1519	96.5	20
20	MBES-1520	101.6	20
21	MBES-1521	106.7	20
22	MBES-1522	111.8	20
23	MBES-1523	116.8	20
24	MBES-1524	121.9	20

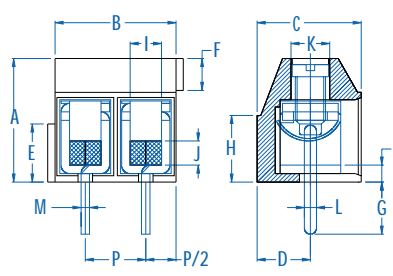

Dimensions

A	10.20 mm	I	2.60 mm
B	10.16 mm	J	2.00 mm
C	7.60 mm	K	Ø3.00 mm
D	3.80 mm	L	1.10 mm
E	4.70 mm	M	0.70 mm
F	2.80 mm	N	-
G	4.30 mm	O	1.40 mm
H	5.30 mm	P	5.08 mm

Fixed PCB Blocks



Pin Spacing: 5.08mm
 Orientation: Vertical
 Clamp Type: Screw Cage
 Design: Modular

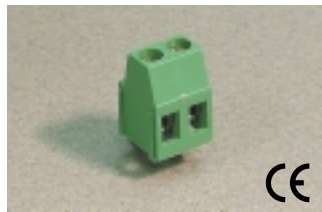

MV-25

ELECTRICAL

	Current	Voltage	Wire Range
	15A ^①	300V	30-14AWG
	16A	450V	2.5mm ² Stranded 4.0mm ² Solid

INSTALLATION DATA

Screw Size	M3	PCB Hole Size	1.3mm
Torque	0.5Nm (4.5 lbf-in.)	Stripping Lgth.	8.3mm

MATERIAL

Body	PA6.8	Screw	Galvanized Steel
Flammability Class	UL94V-0	Terminal	Tin-Plated Brass
Temperature Limit	105°C UL 125°C IEC	Clamp	Nickeled Brass
Color	Green		

No. Poles	Cat. #	Length (B) (mm)	Std. Pk.
2	MV-252	10.2	100
3	MV-253	15.2	100
4	MV-254	20.3	50
5	MV-255	25.4	50
6	MV-256	30.5	50
7	MV-257	35.6	50
8	MV-258	40.6	50
9	MV-259	45.7	50
10	MV-2510	50.8	50
11	MV-2511	55.9	50
12	MV-2512	61.0	50
13	MV-2513	66.0	20
14	MV-2514	71.1	20
15	MV-2515	76.2	20
16	MV-2516	81.3	20
17	MV-2517	86.4	20
18	MV-2518	91.4	20
19	MV-2519	96.5	20
20	MV-2520	101.6	20
21	MV-2521	106.7	20
22	MV-2522	111.8	20
23	MV-2523	116.8	20
24	MV-2524	121.9	20

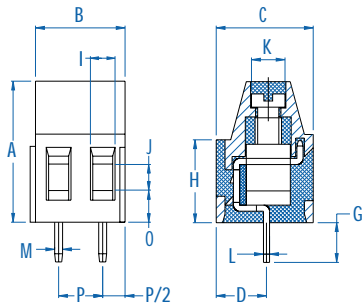

Dimensions

A	16.00 mm	I	2.80 mm
B	10.16 mm	J	2.80 mm
C	11.00 mm	K	Ø3.80 mm
D	5.00 mm	L	0.70 mm
E	-	M	0.90 mm
F	-	N	-
G	4.50 mm	O	3.60 mm
H	9.40 mm	P	5.08 mm

Pin Spacing: 5.08mm
 Orientation: Vertical
 Clamp Type: Screw Cage
 Design: Modular



MV-25-D

ELECTRICAL

	Current	Voltage	Wire Range
	24A	300V	30-14AWG
	24A	450V	2.5mm ² Stranded 4.0mm ² Solid

INSTALLATION DATA

Screw Size	M3	PCB Hole Size	1.3mm
Torque	0.5Nm (4.5 lbf-in.)	Stripping Lgth.	8.3mm

MATERIAL

Body	PA6.8	Screw	Galvanized Steel
Flammability Class	UL94V-0	Terminal	Tin-Plated Brass
Temperature Limit	105°C UL 125°C IEC	Clamp	Nickeled Brass
Color	Green		

No. Poles	Cat. #	Length (B) (mm)	Std. Pk.
2	MV-252-D	10.2	100
3	MV-253-D	15.2	100
4	MV-254-D	20.3	50
5	MV-255-D	25.4	50
6	MV-256-D	30.5	50
7	MV-257-D	35.6	50
8	MV-258-D	40.6	50
9	MV-259-D	45.7	50
10	MV-2510-D	50.8	50
11	MV-2511-D	55.9	50
12	MV-2512-D	61.0	50
13	MV-2513-D	66.0	20
14	MV-2514-D	71.1	20
15	MV-2515-D	76.2	20
16	MV-2516-D	81.3	20
17	MV-2517-D	86.4	20
18	MV-2518-D	91.4	20
19	MV-2519-D	96.5	20
20	MV-2520-D	101.6	20
21	MV-2521-D	106.7	20
22	MV-2522-D	111.8	20
23	MV-2523-D	116.8	20
24	MV-2524-D	121.9	20

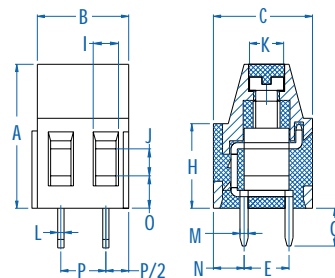

Dimensions

A	16.00 mm	I	2.80 mm
B	10.16 mm	J	2.80 mm
C	11.00 mm	K	Ø3.80 mm
D	-	L	0.70 mm
E	5.00 mm	M	0.90 mm
F	-	N	3.40 mm
G	4.50 mm	O	3.60 mm
H	9.40 mm	P	5.08 mm

^① 16A Factory Wiring - UL

Fixed PCB Blocks

Pin Spacing: 5.08mm*
 Orientation: Vertical
 Clamp Type: Screw Cage
 Design: Modular

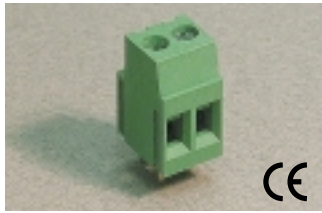

MVSP-25

ELECTRICAL

	Current	Voltage	Wire Range
US Pending	24A	300V	30-14AWG
	24A	450V	2.5mm ² Stranded 4.0mm ² Solid

INSTALLATION DATA

Screw Size	M3	PCB Hole Size	1.5mm
Torque	0.5Nm (4.5 lbf-in.)	Stripping Lgth.	9.5mm

MATERIAL

Body	PA6.8	Screw	Galvanized Steel
Flammability Class	UL94V-0	Terminal	Tin-Plated Brass
Temperature Limit	105°C UL 125°C IEC	Clamp	Nickel Brass
Color	Green		

No. Poles	Cat. #	Length (B) (mm)	Std. Pk.
2	MVSP-252	10.2	100
3	MVSP-253	15.2	100
4	MVSP-254	20.3	50
5	MVSP-255	25.4	50
6	MVSP-256	30.5	50
7	MVSP-257	35.6	50
8	MVSP-258	40.6	50
9	MVSP-259	45.7	50
10	MVSP-2510	50.8	50
11	MVSP-2511	55.9	50
12	MVSP-2512	61.0	50
13	MVSP-2513	66.0	20
14	MVSP-2514	71.1	20
15	MVSP-2515	76.2	20
16	MVSP-2516	81.3	20
17	MVSP-2517	86.4	20
18	MVSP-2518	91.4	20
19	MVSP-2519	96.5	20
20	MVSP-2520	101.6	20
21	MVSP-2521	106.7	20
22	MVSP-2522	111.8	20
23	MVSP-2523	116.8	20
24	MVSP-2524	121.9	20

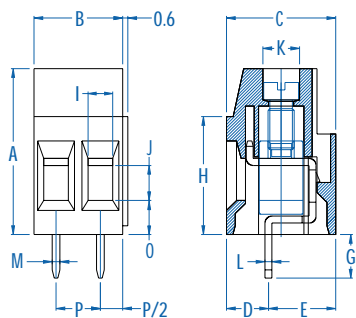

Dimensions

A	19.00 mm	I	2.80 mm
B	10.16 mm	J	4.00 mm
C	12.50 mm	K	Ø4.00 mm
D	4.80 mm	L	0.80 mm
E	7.70 mm	M	1.00 mm
F	-	N	-
G	5.00 mm	O	3.90 mm
H	13.50 mm	P	5.08 mm

* Also available in 10.16mm pin spacing.

Pin Spacing: 5.08mm
 Orientation: Horizontal
 Clamp Type: Screw Cage
 Design: Modular

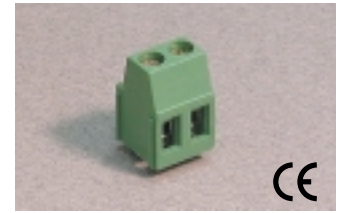

MH-25

ELECTRICAL

	Current	Voltage	Wire Range
US	15A ^①	300V	30-14AWG
	16A	450V	2.5mm ² Stranded 4.0mm ² Solid

INSTALLATION DATA

Screw Size	M3	PCB Hole Size	1.3mm
Torque	0.5Nm (4.5 lbf-in.)	Stripping Lgth.	8.3mm

MATERIAL

Body	PA6.8	Screw	Galvanized Steel
Flammability Class	UL94V-0	Terminal	Tin-Plated Brass
Temperature Limit	105°C UL 125°C IEC	Clamp	Nickel Brass
Color	Green		

No. Poles	Cat. #	Length (B) (mm)	Std. Pk.
2	MH-252	10.2	100
3	MH-253	15.2	100
4	MH-254	20.3	50
5	MH-255	25.4	50
6	MH-256	30.5	50
7	MH-257	35.6	50
8	MH-258	40.6	50
9	MH-259	45.7	50
10	MH-2510	50.8	50
11	MH-2511	55.9	50
12	MH-2512	61.0	50
13	MH-2513	66.0	20
14	MH-2514	71.1	20
15	MH-2515	76.2	20
16	MH-2516	81.3	20
17	MH-2517	86.4	20
18	MH-2518	91.4	20
19	MH-2519	96.5	20
20	MH-2520	101.6	20
21	MH-2521	106.7	20
22	MH-2522	111.8	20
23	MH-2523	116.8	20
24	MH-2524	121.9	20

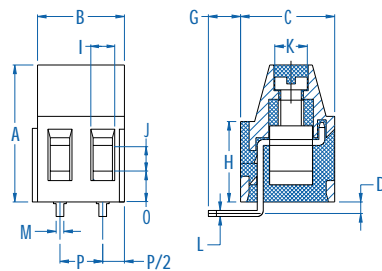

Dimensions

A	16.00 mm	I	2.80 mm
B	10.16 mm	J	2.80 mm
C	11.00 mm	K	Ø3.80 mm
D	2.00 mm	L	0.70 mm
E	-	M	0.90 mm
F	-	N	-
G	3.60 mm	O	3.60 mm
H	9.40 mm	P	5.08 mm

① 16A Factory Wiring - UL

Fixed PCB Blocks



Pin Spacing: 5.08mm*
 Orientation: Horizontal
 Clamp Type: Screw Cage
 Design: Modular

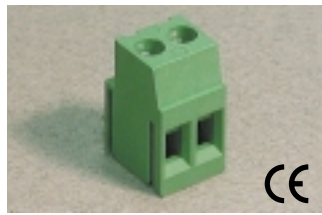

MHSP-25

ELECTRICAL

	Current	Voltage	Wire Range
US Pending	24A	300V	30-14AWG
	24A	450V	2.5mm ² Stranded 4.0mm ² Solid

INSTALLATION DATA

Screw Size	M3	PCB Hole Size	1.5mm
Torque	0.5Nm (4.5 lbf-in.)	Stripping Lgth.	9.5mm

MATERIAL

Body	PA6.8	Screw	Galvanized Steel
Flammability Class	UL94V-0	Terminal	Tin-Plated Brass
Temperature Limit	105°C UL 125°C IEC	Clamp	Nickeled Brass
Color	Green		

No. Poles	Cat. #	Length (B) (mm)	Std. Pk.
2	MHSP-252	10.2	100
3	MHSP-253	15.2	100
4	MHSP-254	20.3	50
5	MHSP-255	25.4	50
6	MHSP-256	30.5	50
7	MHSP-257	35.6	50
8	MHSP-258	40.6	50
9	MHSP-259	45.7	50
10	MHSP-2510	50.8	50
11	MHSP-2511	55.9	50
12	MHSP-2512	61.0	50
13	MHSP-2513	66.0	20
14	MHSP-2514	71.1	20
15	MHSP-2515	76.2	20
16	MHSP-2516	81.3	20
17	MHSP-2517	86.4	20
18	MHSP-2518	91.4	20
19	MHSP-2519	96.5	20
20	MHSP-2520	101.6	20
21	MHSP-2521	106.7	20
22	MHSP-2522	111.8	20
23	MHSP-2523	116.8	20
24	MHSP-2524	121.9	20

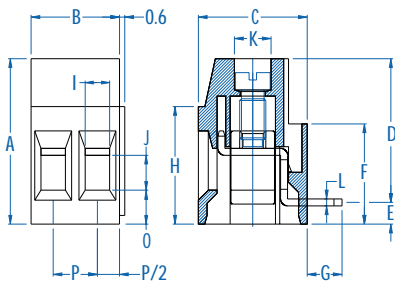

Dimensions

A	19.00 mm	I	2.80 mm
B	10.16 mm	J	4.00 mm
C	12.50 mm	K	Ø4.00 mm
D	16.50 mm	L	0.80 mm
E	2.50 mm	M	1.00 mm
F	11.50 mm	N	-
G	4.00 mm	O	3.90 mm
H	13.50 mm	P	5.08 mm

* Also available in 10.16mm pin spacing.

Pin Spacing: 5.08mm
 Orientation: 35°
 Clamp Type: Screw Cage
 Design: Modular

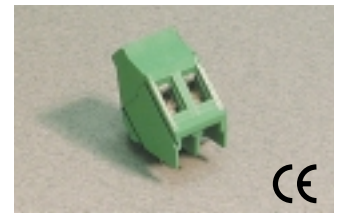

MI-25 (35)

ELECTRICAL

	Current	Voltage	Wire Range
US	15A ^①	300V	30-14AWG
	16A	450V	2.5mm ² Stranded 4.0mm ² Solid

INSTALLATION DATA

Screw Size	M3	PCB Hole Size	1.3mm
Torque	0.5Nm (4.5 lbf-in.)	Stripping Lgth.	8.3mm

MATERIAL

Body	PA6.8	Screw	Galvanized Steel
Flammability Class	UL94V-0	Terminal	Tin-Plated Brass
Temperature Limit	105°C UL 125°C IEC	Clamp	Nickeled Brass
Color	Green		

No. Poles	Cat. #	Length (B) (mm)	Std. Pk.
2	MI-252 (35)	10.2	100
3	MI-253 (35)	15.2	100
4	MI-254 (35)	20.3	50
5	MI-255 (35)	25.4	50
6	MI-256 (35)	30.5	50
7	MI-257 (35)	35.6	50
8	MI-258 (35)	40.6	50
9	MI-259 (35)	45.7	50
10	MI-2510 (35)	50.8	50
11	MI-2511 (35)	55.9	50
12	MI-2512 (35)	61.0	50
13	MI-2513 (35)	66.0	20
14	MI-2514 (35)	71.1	20
15	MI-2515 (35)	76.2	20
16	MI-2516 (35)	81.3	20
17	MI-2517 (35)	86.4	20
18	MI-2518 (35)	91.4	20
19	MI-2519 (35)	96.5	20
20	MI-2520 (35)	101.6	20
21	MI-2521 (35)	106.7	20
22	MI-2522 (35)	111.8	20
23	MI-2523 (35)	116.8	20
24	MI-2524 (35)	121.9	20

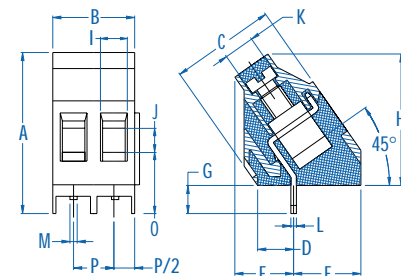

Dimensions

A	20.00 mm	I	2.80 mm
B	10.16 mm	J	2.80 mm
C	13.00 mm	K	Ø3.80 mm
D	4.50 mm	L	0.70 mm
E	7.70 mm	M	0.90 mm
F	7.30 mm	N	-
G	4.00 mm	O	6.75 mm
H	16.30 mm	P	5.08 mm

① 16A Factory Wiring - UL

Fixed PCB Blocks

Pin Spacing: 5.08mm
 Orientation: 45°
 Clamp Type: Screw Cage
 Design: Modular

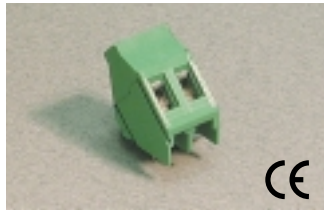

MI-25 (45)

ELECTRICAL

	Current	Voltage	Wire Range
	15A ^①	300V	30-14AWG
	16A	450V	2.5mm ² Stranded 4.0mm ² Solid

INSTALLATION DATA

Screw Size	M3	PCB Hole Size	1.3mm
Torque	0.5Nm (4.5 lbf-in.)	Stripping Lgth.	8.3mm

MATERIAL

Body	PA6.8	Screw	Galvanized Steel
Flammability Class	UL94V-0	Terminal	Tin-Plated Brass
Temperature Limit	105°C UL 125°C IEC	Clamp	Nickel Brass
Color	Green		

No. Poles	Cat. #	Length (B) (mm)	Std. Pk.
2	MI-252 (45)	10.2	100
3	MI-253 (45)	15.2	100
4	MI-254 (45)	20.3	50
5	MI-255 (45)	25.4	50
6	MI-256 (45)	30.5	50
7	MI-257 (45)	35.6	50
8	MI-258 (45)	40.6	50
9	MI-259 (45)	45.7	50
10	MI-2510 (45)	50.8	50
11	MI-2511 (45)	55.9	50
12	MI-2512 (45)	61.0	50
13	MI-2513 (45)	66.0	20
14	MI-2514 (45)	71.1	20
15	MI-2515 (45)	76.2	20
16	MI-2516 (45)	81.3	20
17	MI-2517 (45)	86.4	20
18	MI-2518 (45)	91.4	20
19	MI-2519 (45)	96.5	20
20	MI-2520 (45)	101.6	20
21	MI-2521 (45)	106.7	20
22	MI-2522 (45)	111.8	20
23	MI-2523 (45)	116.8	20
24	MI-2524 (45)	121.9	20

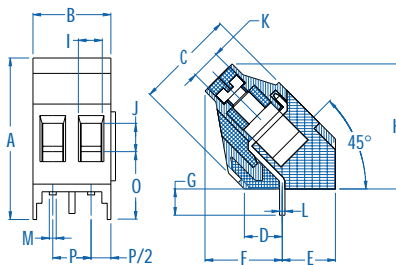

Dimensions

A	21.00 mm	I	2.80 mm
B	10.16 mm	J	2.80 mm
C	13.00 mm	K	Ø3.80 mm
D	4.50 mm	L	0.70 mm
E	7.70 mm	M	0.90 mm
F	10.00 mm	N	-
G	4.00 mm	O	8.60 mm
H	16.30 mm	P	5.08 mm

① 16A Factory Wiring - UL

Pin Spacing: 5.08mm
 Orientation: Vertical-Double Level
 Clamp Type: Screw Cage
 Design: Modular-Offset

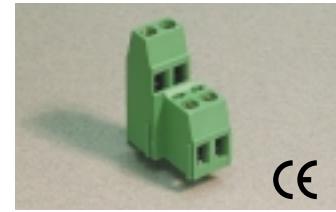

MVD-25

ELECTRICAL

	Current	Voltage	Wire Range
	15A ^①	300V	30-14AWG
	16A	450V	2.5mm ² Stranded 4.0mm ² Solid

INSTALLATION DATA

Screw Size	M3	PCB Hole Size	1.3mm
Torque	0.5Nm (4.5 lbf-in.)	Stripping Lgth.	8.3mm

MATERIAL

Body	PA6.8	Screw	Galvanized Steel
Flammability Class	UL94V-0	Terminal	Tin-Plated Brass
Temperature Limit	105°C UL 125°C IEC	Clamp	Nickel Brass
Color	Green		

No. Poles	Cat. #	Length (B) (mm)	Std. Pk.
4	MVD-252	12.7	100
6	MVD-253	17.8	100
8	MVD-254	22.9	50
10	MVD-255	27.9	50
12	MVD-256	33.0	50
14	MVD-257	38.1	50
16	MVD-258	43.2	50
18	MVD-259	48.3	50
20	MVD-2510	53.3	50
22	MVD-2511	58.4	20
24	MVD-2512	63.5	20
26	MVD-2513	68.6	20
28	MVD-2514	73.7	20
30	MVD-2515	78.7	20
32	MVD-2516	83.2	20
34	MVD-2517	88.9	20
36	MVD-2518	94.0	20
38	MVD-2519	99.1	20
40	MVD-2520	104.1	10
42	MVD-2521	109.2	10
44	MVD-2522	114.3	10
46	MVD-2523	119.4	10
48	MVD-2524	124.5	10
50	MVD-2525	129.5	10

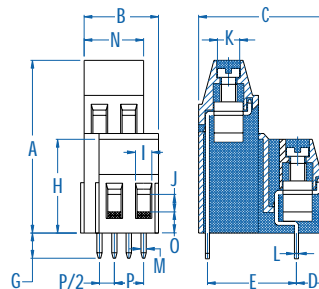

Dimensions

A	29.50 mm	I	2.80 mm
B	12.70 mm	J	2.80 mm
C	22.00 mm	K	Ø3.80 mm
D	5.30 mm	L	0.70 mm
E	15.24 mm	M	0.90 mm
F	-	N	10.16 mm
G	4.70 mm	O	3.60 mm
H	16.00 mm	P	5.08 mm

① 16A Factory Wiring - UL