

Tous droits strictement réservés. Reproduction ou communication à des tiers interdite, sous quelque forme que ce soit sans autorisation écrite du propriétaire. Propriété de c.FCI. Droits de reproduction FCI.

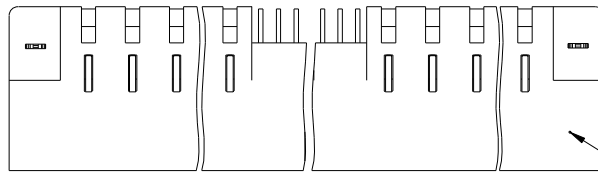

All rights strictly reserved. Reproduction or issue to third parties in any form whatever is not permitted without written authority from the proprietor. Property of FCI. Copyright FCI.

PRODUCT NUMBER
51720- ABBCCDDEF...
NOTE ①



SEE NOTE 9

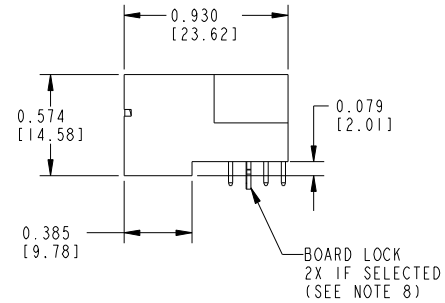
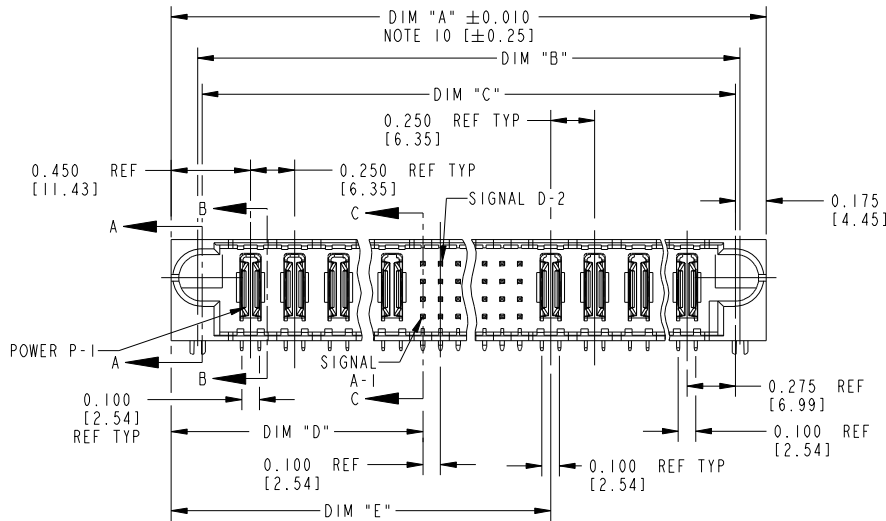

mat'l code SEE NOTE 2				tolerances unless otherwise specified		CUSTOMER COPY		FCI www.fciconnect.com	
ltr	ecn no.	dr	date	linear	.XX±.01/.X±.3	projection		title RIGHT ANGLE HEADER w/GUIDE PIN POWER / SIGNAL / POWER	
J	DG05-0132	SJ	05/23/05		.XXX±.005/.XX±.13			product family	PwrBlade
K	DG05-0485	GuoJM	11/21/05	angles	.XXXX±.0020/.XXX±.051		size		213
L	DG07-0498	JW	05/23/08		0°±2°	INCH / MM	scale		
M	DG08-0272	WD	09/28/08	dr	C. BAROT 05-04-99	1:1	dwg no	51720	SHEET 1 OF 3
N	DG10-0180	AL	05/13/10	enr	RYAN YUAN 11/08/06				
P	DG10-0364	AL	10/25/10	chr	J. BROWN 05-04-99				
				appd	J. BROWN 05-04-99				
sheet index	revision sheet	P 1	P 2	P 3					

form no. 7530-001-103

cage code 22526

Tous droits strictement reserves. Reproduction ou communication a des tiers interdite, sous quelque forme que ce soit sans autorisation ecrite du propriétaire. Propriete de c FCI. Droits de reproduction FCI.



All rights strictly reserved. Reproduction or issue to third parties in any form whatever is not permitted without written authority from the proprietor. Property of FCI. Copyright FCI.

PRODUCT NUMBER	DIM	LENGTH FORMULAS (SEE NOTE 10)
51720- ABBCCDDEF -- NOTE ①	DIM "A"	.250 [6.35] x BB + .100 [2.54] x (CCC/4) + .250 [6.35] x DD + .650 [16.51](NOTE 10)
	DIM "B"	.250 [6.35] x BB + .100 [2.54] x (CCC/4) + .250 [6.35] x DD + .350 [8.89]
	DIM "C"	.250 [6.35] x BB + .100 [2.54] x (CCC/4) + .250 [6.35] x DD + .300 [7.62]
	DIM "D"	.250 [6.35] x BB + .375 [9.53]
	DIM "E"	.250 [6.35] x BB + .100 [2.54] x (CCC/4) + .450 [11.43]
	DIM "F"	.250 [6.35] x BB + .100 [2.54] x (CCC/4) + .250 [6.35] x DD + .680 [17.27]
	DIM "G"	.250 [6.35] x BB + .225 [5.72]
	DIM "H"	.250 [6.35] x BB + .100 [2.54] x (CCC/4) + .250 [6.35]

CONNECTOR NOTES

- ① PRODUCT NUMBER CODE:
51720 - A BB CCC DD E F LF
- NO THIS SUFFIX: 100u"/12.5um SnPb ON PCB INTERFACE
 - ADD THIS SUFFIX: 78u"/12.00um Sn OR 5u" Au ON PCB INTERFACE
 - RETENTION TO PCB (NOTE 8)
 - TAIL OPTIONS (NOTE 7)
 - NUMBER OF RIGHT END POWER CONTACTS (NOTE 6)
 - NUMBER OF SIGNAL CONTACTS (NOTE 5)
 - NUMBER OF LEFT END POWER CONTACTS (NOTE 4)
 - PLATING (NOTE 3)
 - BASE NUMBER

- ② HOUSING MATERIAL: GLASS FILLED V-O HIGH TEMP THERMO PLASTIC.
SIGNAL CONTACT MATERIAL: COPPER ALLOY
POWER CONTACT MATERIAL: COPPER ALLOY
- ③ PLATING OPTION:
1: SEE ITEM PRINT 10064183 FOR PLATING SPEC OF 51720-ABBCCDDEF; 51720-ABBCCDDEFLF
- ④ LEFT END POWER CONTACTS, 01 TO 20 AVAILABLE.
MAXIMUM OF 20 POWER CONTACTS PER CONNECTOR.
- ⑤ SIGNAL CONTACTS, 004 TO 148 AVAILABLE.
6. RIGHT END POWER CONTACTS, 01 TO 20 AVAILABLE.
MAXIMUM OF 20 POWER CONTACTS PER CONNECTOR.
7. TAIL OPTIONS:
A = .135 [3.43] SOLDER TO BOARD

8. RETENTION TO PCB OPTIONS:
A = BOARD LOCK (REQUIRES .098 + .002, -.001 [2.49 +0.05, -0.03] THRU HOLE IN PCB).
MOUNTING FOOT THICKNESS: .220[5.59]
B = .150 [3.81] THRU HOLE (REQUIRES .158±.003 [4.01±08] THRU HOLE IN PCB).
MOUNTING FOOT THICKNESS: .160[4.06]
9. MANUFACTURE'S NAME, P/N, AND DATE CODE TO APPEAR ON THIS SURFACE.
10. THE MAXIMUM OVERALL LENGTH (DIM A) OF A PART IS 8.00 [203.2]
11. PRODUCT SPECIFICATION GS-12-149
12. REFERENCE 51697 FOR SPECIALS WORKSHEET.

PCB NOTES:

13. ALL DIMENSIONS ARE BASIC UNLESS OTHERWISE SPECIFIED.
14. ALL THROUGH HOLES ARE LOCATED WITH A TRUE POSITION OF .004[0.10]
15. ALL HOLE DIAMETERS ARE FINISHED HOLE SIZE.
16. Ø0.0453 ±.001 [1.151 ±0.02] DRILLED HOLES PLATED WITH 0.0003 [0.007] MIN SnPb OVER 0.001 [1.03] TO .003 [0.08] PLATING TO ACHIEVE A .040±.003 [1.02±08] HOLE.
17. A Δ SYMBOL WILL BE NEXT TO ANY DIMENSION, VIEW, OR NOTE WHICH HAS BEEN MODIFIED WITH THE CURRENT DRAWING REVISION.

THIS FILE WAS ORIGINALLY CREATED IN THE PRO ENGINEER ENVIRONMENT AND ANY FUTURE REVISIONS TO THIS FILE MUST BE MADE IN THE PRO ENGINEER ENVIRONMENT

mat'l code		tolerances unless otherwise specified		CUSTOMER COPY		FCI www.fciconnect.com	
ltr	ecr no.	dr	date	linear	.XX±.01/.X±.3	projection	title
P					.XXX±.005/.XX±.13		RIGHT ANGLE HEADER w/GUIDE PIN POWER / SIGNAL / POWER
				angles	.XXX±.0020/.XXX±.051		
				dr	0°±2°	INCH / MM	product family
				enr	C. BAROT 05-04-99	← →	PwrBlade
				chr	RYAN YUAN 11/08/06	scale	code
				appd	J. BROWN 05-04-99	1:1	213
					J. BROWN 05-04-99	A	size
sheet index	revision sheet						dwg no
							51720
							SHEET 2 OF 3

form no. 7530-001-103

cage code 22526

Tous droits strictement réservés. Reproduction ou communication à des tiers interdite, sous quelque forme que ce soit sans autorisation écrite du propriétaire. Propriété de c.FCI. Droits de reproduction FCI.



All rights strictly reserved. Reproduction or issue to third parties in any form whatever is not permitted without written authority from the proprietor. Property of FCI. Copyright FCI.

PRODUCT NUMBER
51720- ABBCCDDEF __
NOTE ①

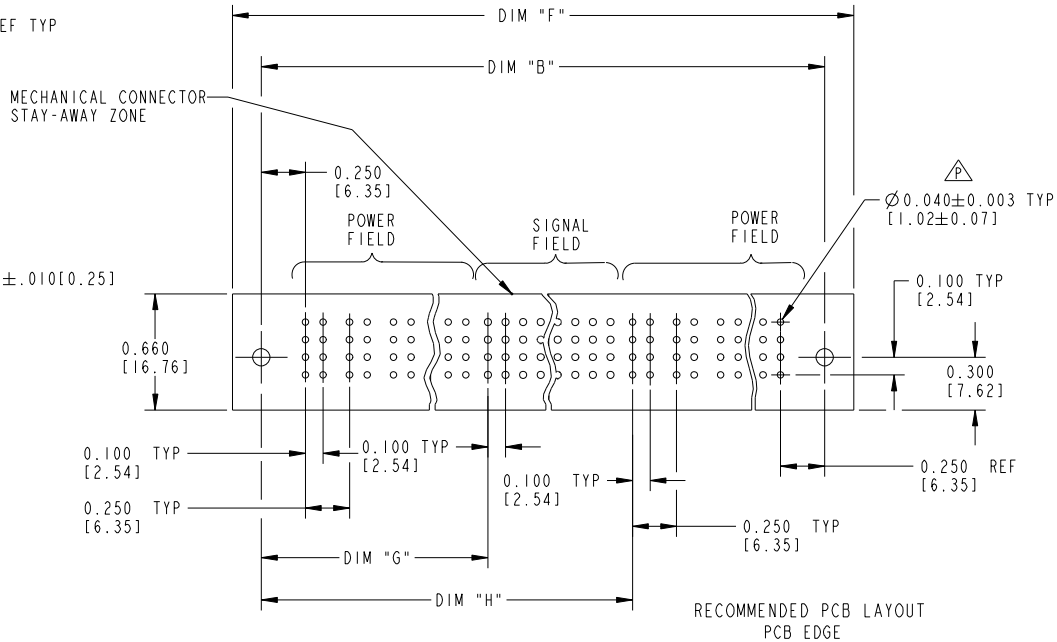
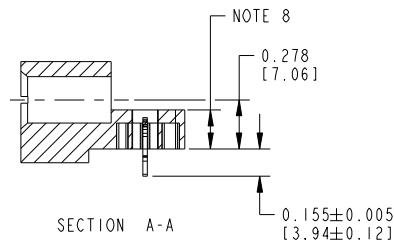
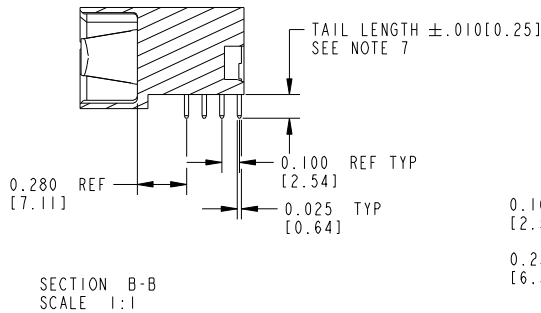
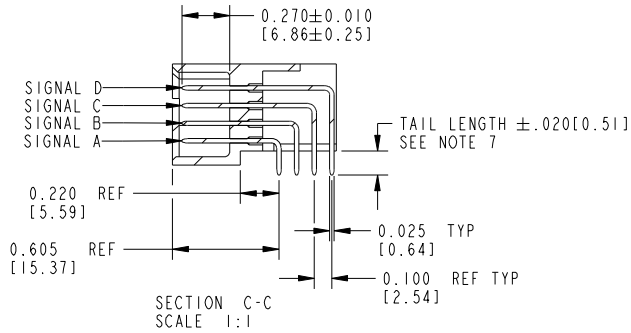

mat'l code				tolerances unless otherwise specified		CUSTOMER COPY		FCI www.fciconnect.com	
ltr	ecn no.	dr	date	linear	.XX±.01/.X±.3	projection		title RIGHT ANGLE HEADER w/GUIDE PIN POWER / SIGNAL / POWER	
P				angles	.XXX±.005/.XX±.13 .XXX±.0020/.XXX±.051	INCH / MM		product family PwrBlade code 213	
				dr	0°±2°	scale 1:1		size dwg no 51720 SHEET 3 OF 3	
				enr	C. BAROT 05-04-99			cage code 22526	
				chr	RYAN YUAN 11/08/06				
				appd	J. BROWN 05-04-99				
sheet index	revision sheet								

form no. 7530-001-103

cage code 22526