

REFERENCE SPECIFICATIONS

-NFC 93425 (in compliance with HE 507)

PHYSICAL CHARACTERISTICS

- INSULATOR MATERIAL: THERMOPLASTIC UL94V0
- CONTACT MATERIAL: BRASS
GOLD OVER NICKEL
- ACCESSORIES: STAINLESS STEEL or BRASS
Cadmium plated, yellow passivation
- SHELLS: STEEL
Cadmium plated, yellow passivation

ELECTRICAL CHARACTERISTICS

- NOMINAL CURRENT: 7.5A (SIGNAL CONTACT)
- CONTACT RESISTANCE: <=7.3 m Ohms SIGNAL
- CONTACT/CONTACT : >=1000 V
- CONTACT/GROUND : >=1200 V
- INSULATION RESISTANCE: >=5000 MOhms
- CLIMATIC CATEGORY: 55/125/21
TEMPERATURE RANGE -55°C TO +125°C
DAMP HEAT STEADY STATE 56 DAYS
SALT SPRAY 48 HOURS

DBML13W3P300N

Series ←

Shell size: **E A B C D** ←
see sheet 3

M :characteristic
for the DM series

Front accessory definition
see sheet 2

Blank :without accessory

L :threaded insert M3

O :threaded insert UNC 4-40

V :female screw UNC 4-40

F :floating mounting

S :spacer

Layout of contacts (see sheet 3) ←

Contacts ←

P :Pin

Termination type ←

3 Straight version

Plating ←

00 straight solder 500 matings/unmatings

43 straight solder 500 matings/unmatings for harsh environment

N :obligatory indication for HE 507 series ←

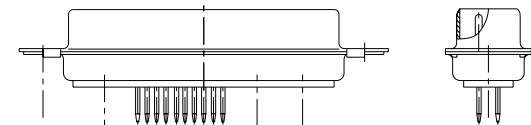

I3W3 FOR EXAMPLE

www.fciconnect.com				surface	tolerance std	projection	mm	
				ISO 1302	ISO 406 ISO 1101	⊕	←	
				TOLERANCES UNLESS OTHERWISE SPECIFIED				
rev	acc no	dr	date	Dr	M PESSON	2006/11/15	ANGULAR	LINEAR
A	LS06-0174	MPE	2006/11/15	Eng	P LEGARE	2006/11/15	0.X	±0.3
B	LS07-0273	MPE	2007/10/30	Chr	P LEGARE	2006/11/15	0.xx	±0.1
-	-	-	-	Appr	P LEGARE	2006/11/15	0.xxx	±0.05
				Product family		size		Scale
				FCI		A2		2:1
				SUB MALE DMW		ECN		LS07-0273
				mixed power straight solder		- Spec ref		
				catalog no		C01-8637-1752		Rev. B
						CUSTOMER		sheet 1 of 7

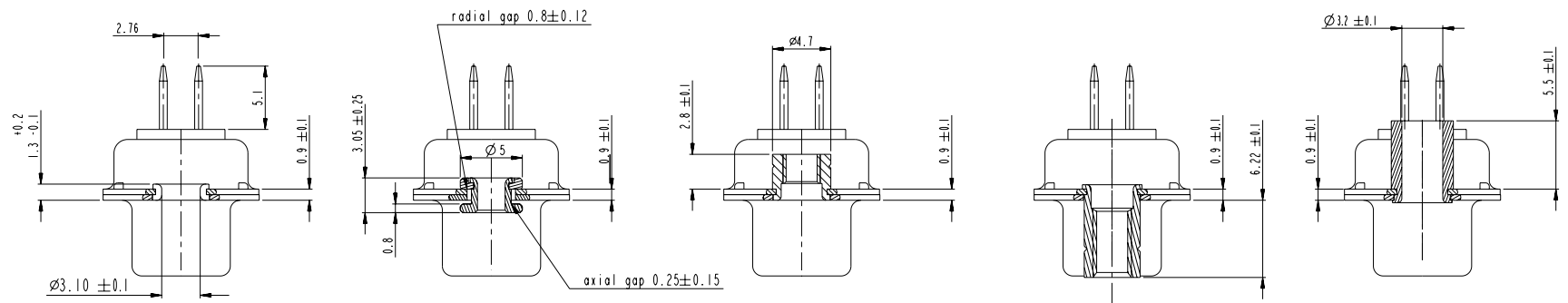

FRONT ACCESSORY **Blank** without **F** floating mounting **L** insert M3 **O** insert UNC 4.40 **V** femelle screw UNC 4.40 **S** Spacer

shell size LAYOUTS

PART NUMBER	FRONT ACCESSORY
D*MxWxP300N	without
D*MFxWxP300N	floating mounting
D*MLxWxP300N	insert M3
D*MOxWxP300N	insert UNC 4.40
D*MVxWxP300N	female screw UNC 4.40
D*MSxWxP300N	Spacer
D*MxWxP343N	without
D*MFxWxP343N	floating mounting
D*MLxWxP343N	insert M3
D*MOxWxP343N	insert UNC 4.40
D*MVxWxP343N	female screw UNC 4.40
D*MSxWxP343N	Spacer

- # xWx
- E 5W1
- A 11W1
- A 7W2
- B 21W1
- B 17W2
- B 13W3
- B 9W4
- C 25W3
- C 21WA4
- C 27W2
- D 47W1
- D 24W7
- D 36W4

Copyright FCJ

www.fciconnect.com		surface ISO 1302	tolerance std ISO 406 ISO 1101	projection mm
		TOLERANCES UNLESS OTHERWISE SPECIFIED		
Dr M PESSON	2006/11/15	ANGULAR	0.X ±0.3	size A2 Scale 2:1
Eng P LEGARE	2006/11/15	LINEAR	0.XX ±0.1	
Chr P LEGARE	2006/11/15	0° ±2°	0.XXX ±0.05	ECN LS07-0273
Appr P LEGARE	2006/11/15	Product family	-	Spec ref

SCALE: 4

FCJ	SUB MALE DMW	dwg no	C01-8637-1752	Rev.	B
	mixed power straight solder	catalog no	CUSTOMER	sheet 2 of 7	

5W1

LAYOUT AND CONNECTOR DIMENSIONS

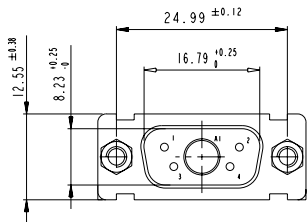
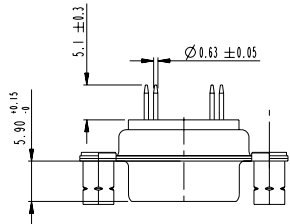
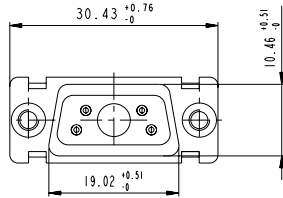
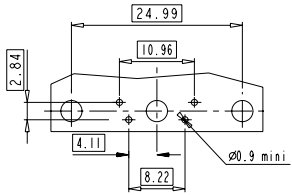

Floating signal contacts

11W1

LAYOUT AND CONNECTOR DIMENSIONS

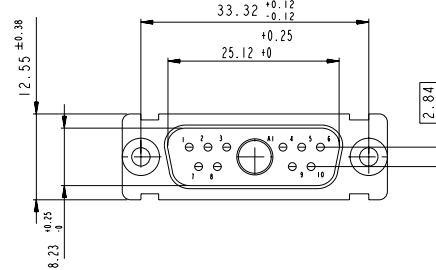
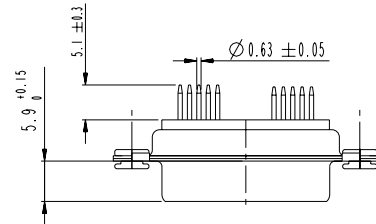
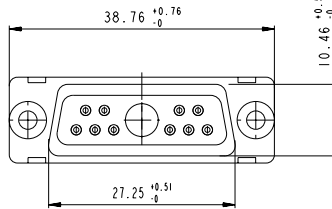
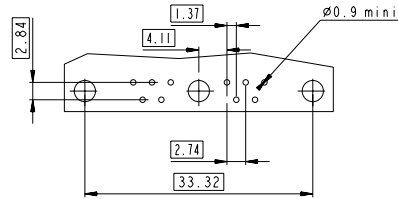

7W2

LAYOUT AND CONNECTOR DIMENSIONS

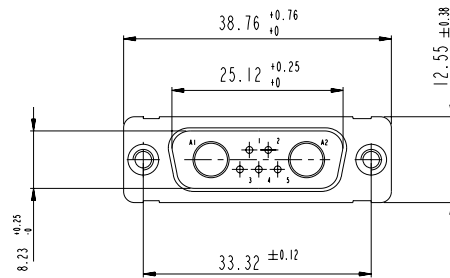
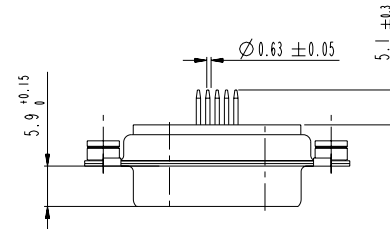
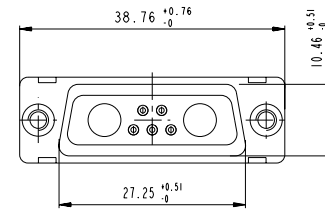
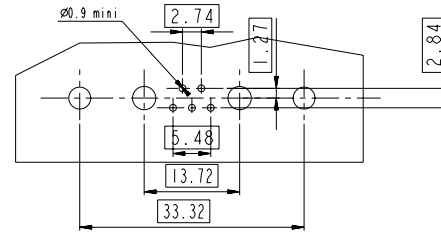

SIDE VIEW FOR LAYOUTS: E A B C

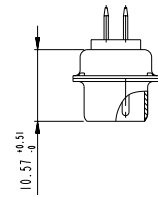

Copyright FCI.

www.fciconnect.com		surface ISO 1302	tolerance std ISO 406 ISO 1101	projection mm
		TOLERANCES UNLESS OTHERWISE SPECIFIED		
Dr M PESSON	2006/11/15	ANGULAR	0.X ±0.3	size A2 Scale 2:1
Eng P LEGARE	2006/11/15	LINEAR	0.XX ±0.1	ECN LS07-0273
Chr P LEGARE	2006/11/15	0° ±2°	0.XXX ±0.05	Spec ref
Appr P LEGARE	2006/11/15	Product family		
TITLE SUB MALE DMW mixed power straight solder catalog no		dwg no C01-8637-1752 Rev. B	CUSTOMER sheet 3 of 7	

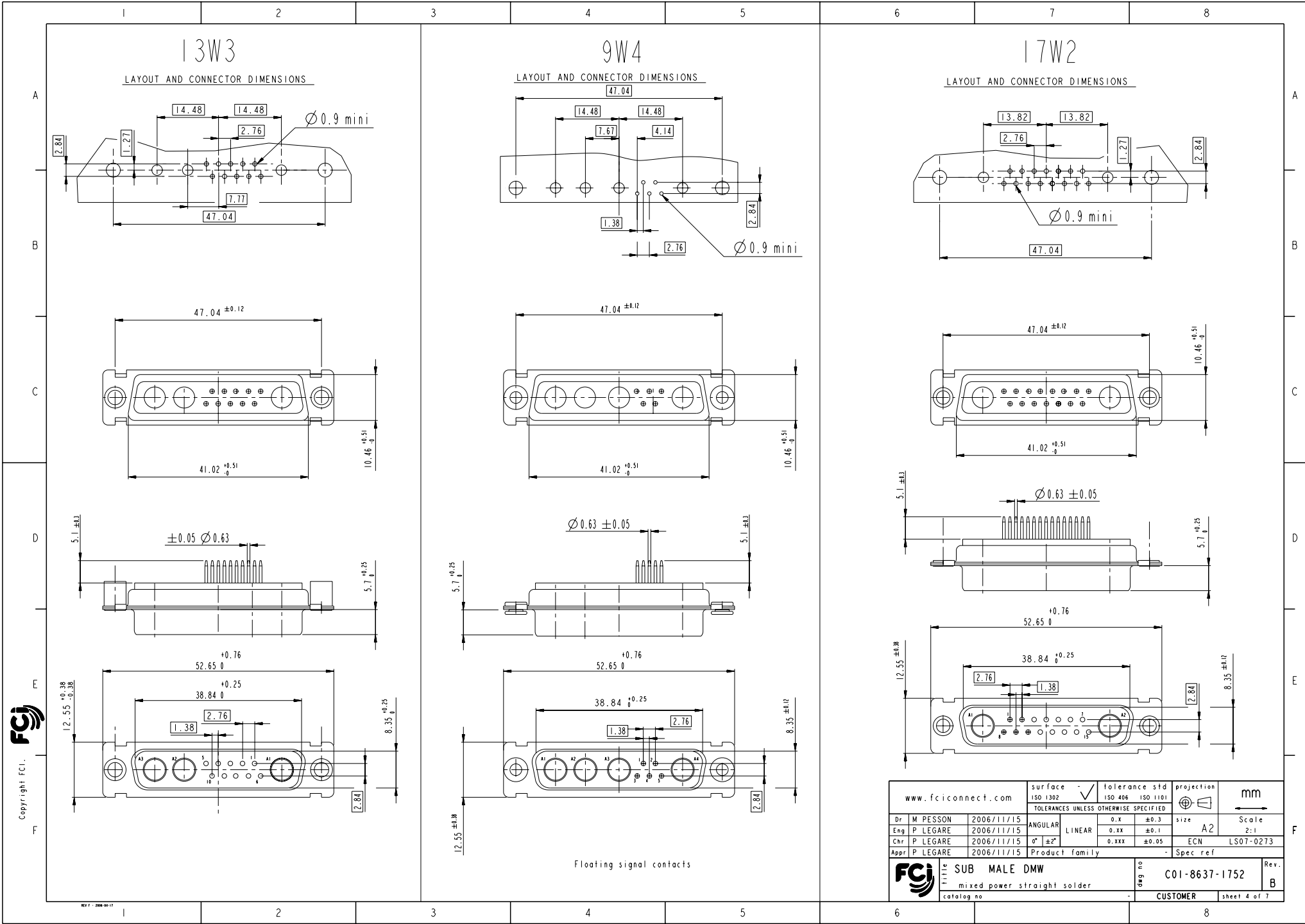

13W3

LAYOUT AND CONNECTOR DIMENSIONS

9W4

LAYOUT AND CONNECTOR DIMENSIONS

17W2

LAYOUT AND CONNECTOR DIMENSIONS

Copyright FCi
FCi

www.fciconnect.com		surface ISO 1302	tolerance std ISO 406 ISO 1101	projection mm
		TOLERANCES UNLESS OTHERWISE SPECIFIED		
Dr M PESSON	2006/11/15	ANGULAR	0.X ±0.3	size A2 Scale 2:1
Eng P LEGARE	2006/11/15	LINEAR	0.XX ±0.1	ECN LS07-0273
Chr P LEGARE	2006/11/15	0° ±2°	0.XXX ±0.05	
Appr P LEGARE	2006/11/15	Product family		Spec ref
		SUB MALE DMW		Rev. B
mixed power straight solder		C01-8637-1752		
catalog no		CUSTOMER		sheet 4 of 7

21W1

LAYOUT AND CONNECTOR DIMENSIONS

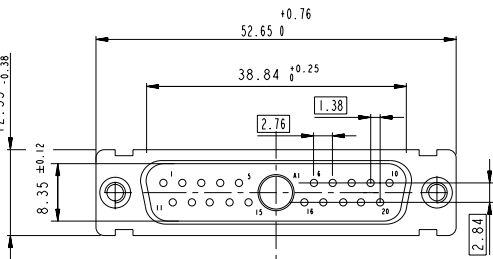
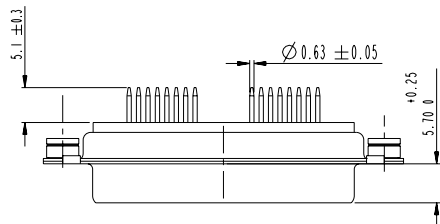
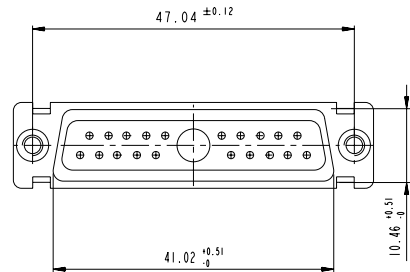
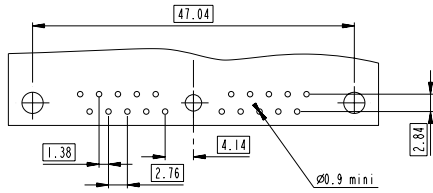

Floating signal contacts

27W2

LAYOUT AND CONNECTOR DIMENSIONS

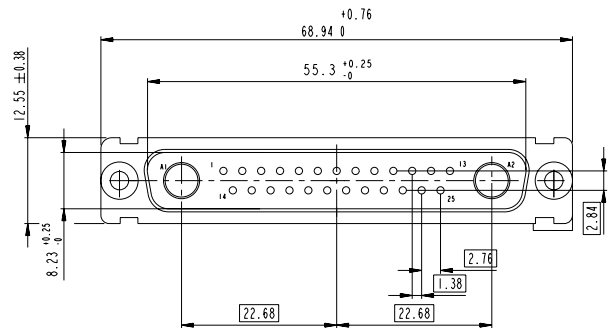
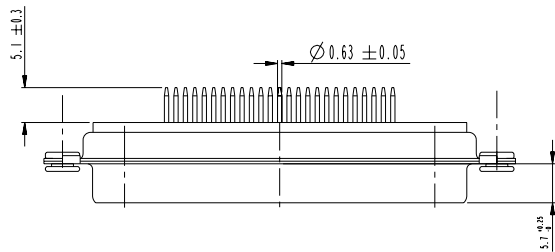
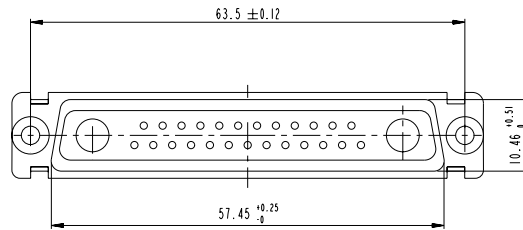
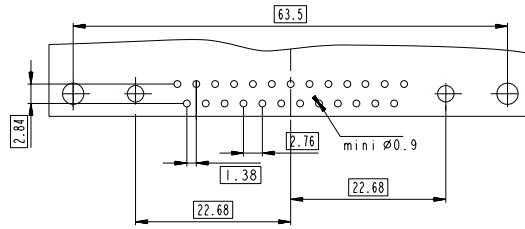

21WA4

LAYOUT AND CONNECTOR DIMENSIONS

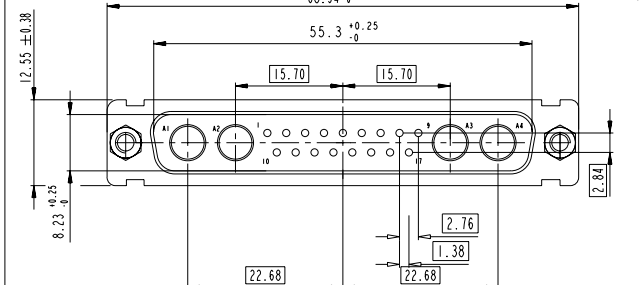
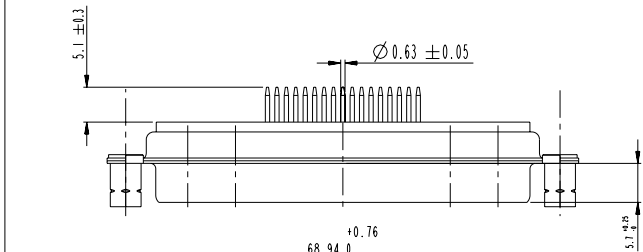
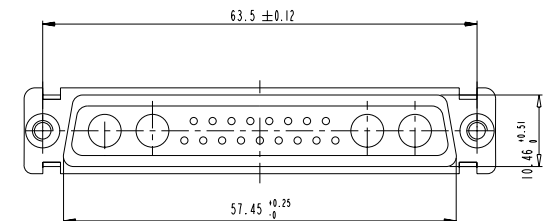
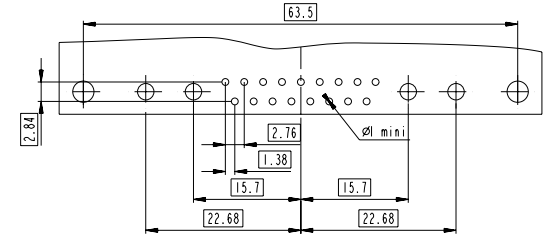

www.fciconnect.com		surface -	tolerance std	projection	mm
		ISO 1302	ISO 406 ISO 1101		
		TOLERANCES UNLESS OTHERWISE SPECIFIED			
Dr	M PESSON	2006/11/15	ANGULAR	0.X ±0.3	size A2 Scale 2:1
Eng	P LEGARE	2006/11/15	LINEAR	0.XX ±0.1	ECN LS07-0273
Chr	P LEGARE	2006/11/15	0° ±2°	0.XXX ±0.05	Product family
Appr	P LEGARE	2006/11/15			Spec ref
		SUB MALE DMW		ang no	Rev.
		mixed power straight solder		C01-8637-1752	B
		catalog no		CUSTOMER	sheet 5 of 7

Copyright FCI.

25W3

LAYOUT AND CONNECTOR DIMENSIONS

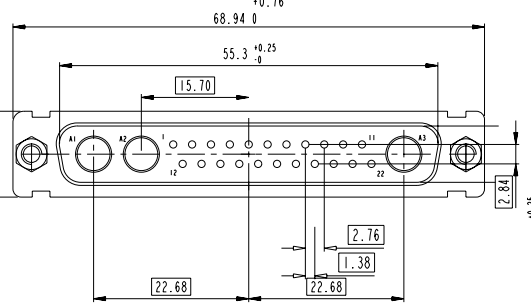
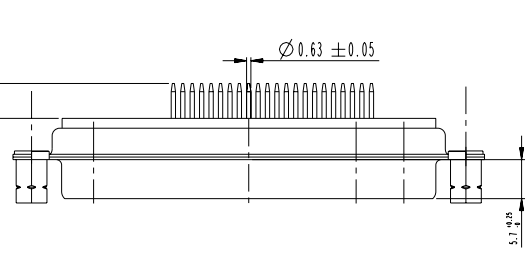
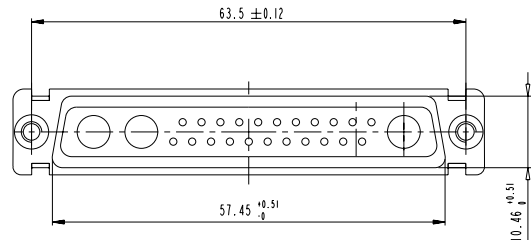
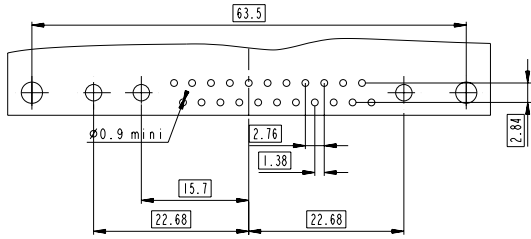

Floating signal contacts

24W7

LAYOUT AND CONNECTOR DIMENSIONS

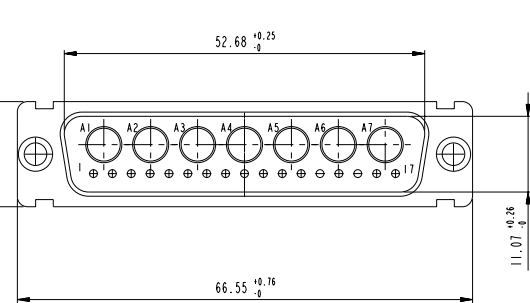
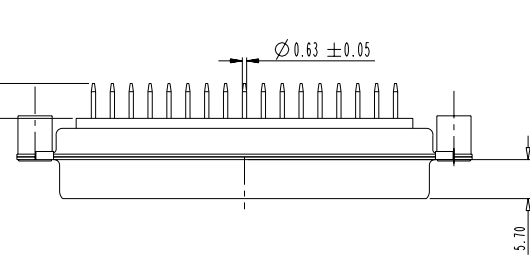
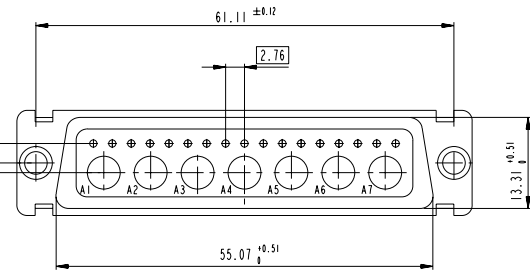
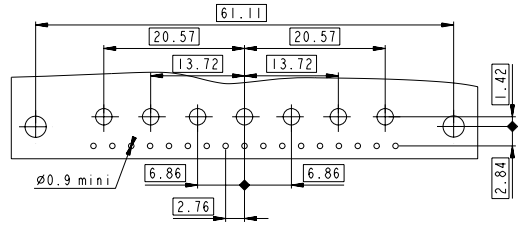

SIDE VIEW FOR LAYOUT: D

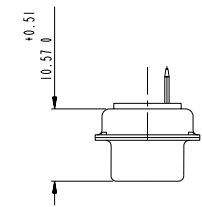

Copyright FCI

www.fciconnect.com		surface ISO 1302	tolerance std ISO 406 ISO 1101	projection mm
		TOLERANCES UNLESS OTHERWISE SPECIFIED		
Dr	M PESSON	2006/11/15	ANGULAR	LINEAR
Eng	P LEGARE	2006/11/15	0.xx	±0.3
Chr	P LEGARE	2006/11/15	0.xxx	±0.1
Appr	P LEGARE	2006/11/15	0.xxx	±0.05
Product family		- Spec ref		
FCI		SUB MALE DMW		Rev. B
mixed power straight solder		C01-8637-1752		
catalog no		CUSTOMER		sheet 6 of 7

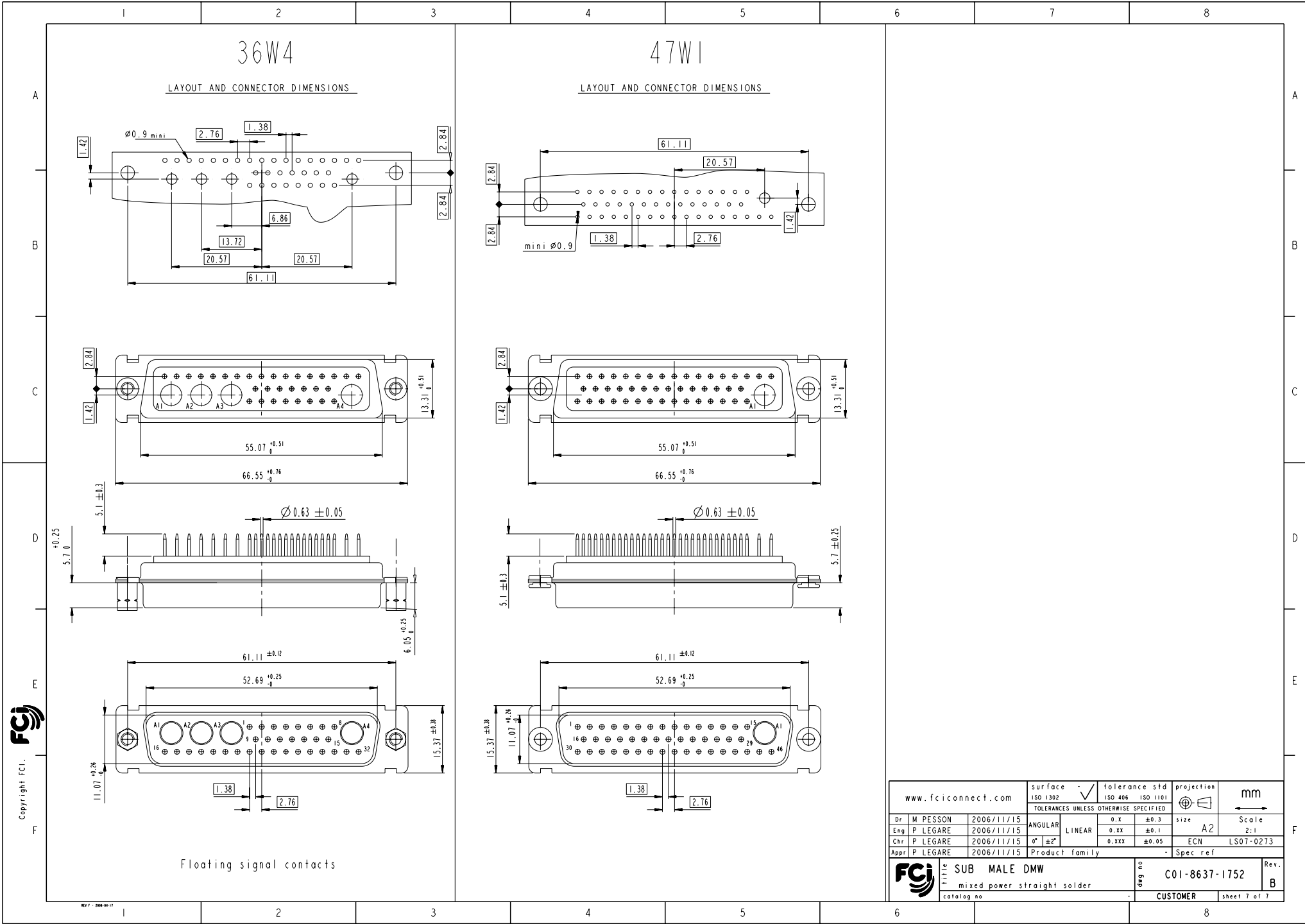

36W4

LAYOUT AND CONNECTOR DIMENSIONS

47W1

LAYOUT AND CONNECTOR DIMENSIONS

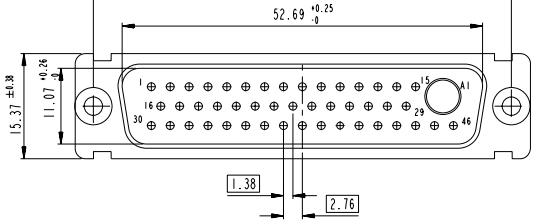
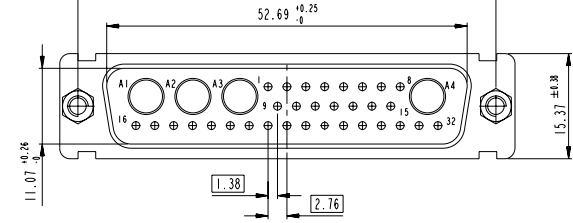
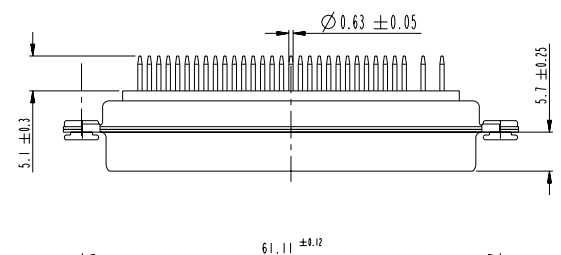
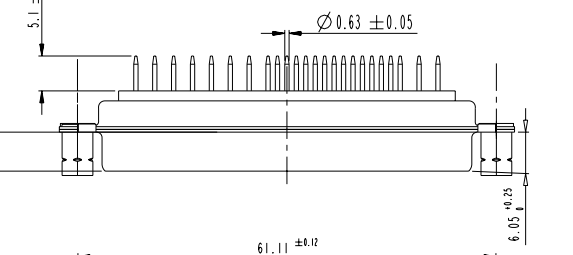
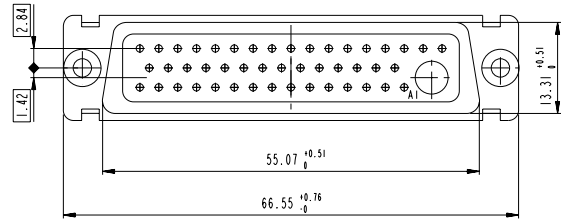
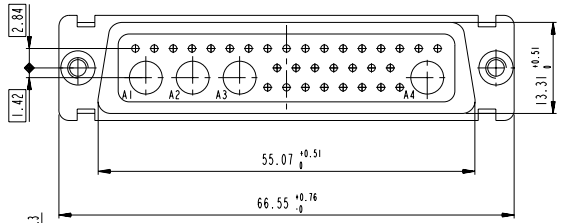
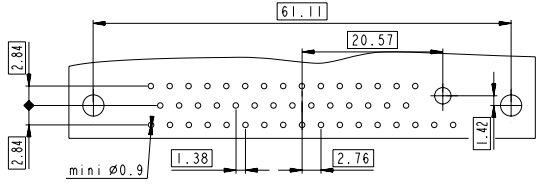
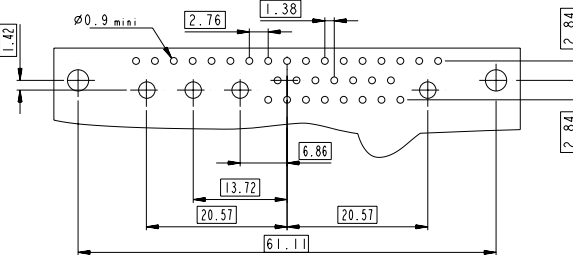

Floating signal contacts

www.fciconnect.com		surface ISO 1302	tolerance std ISO 406 ISO 1101	projection mm
		TOLERANCES UNLESS OTHERWISE SPECIFIED		
Dr M PESSON	2006/11/15	ANGULAR	0.X ±0.3	size A2
Eng P LEGARE	2006/11/15	LINEAR	0.XX ±0.1	Scale 2:1
Chr P LEGARE	2006/11/15	Ø ±2°	0.XXX ±0.05	ECN LS07-0273
Appr P LEGARE	2006/11/15	Product family	-	Spec ref
FCI SUB MALE DMW		catalog no	C01-8637-1752	Rev. B
mixed power straight solder		CUSTOMER		sheet 7 of 7

Copyright FCI.