

REV.	DATE	DESCRIPTION
NC	05/05/97	INITIAL RELEASE

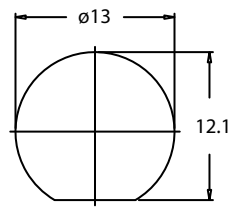

RECOMMENDED MOUNTING HOLE

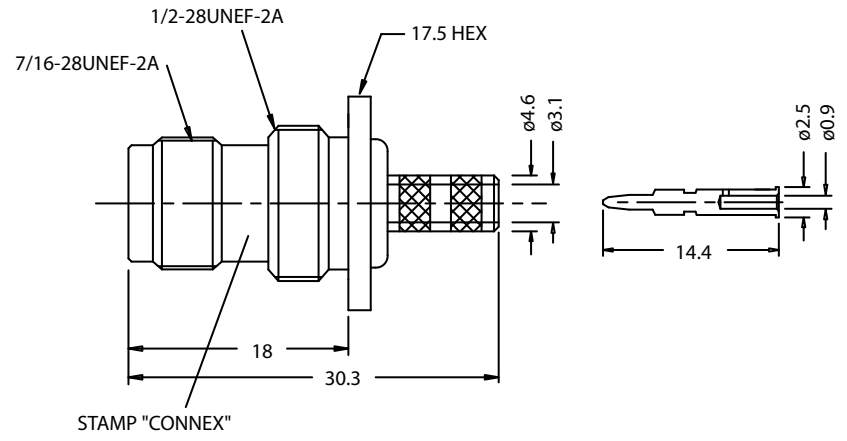
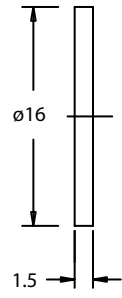
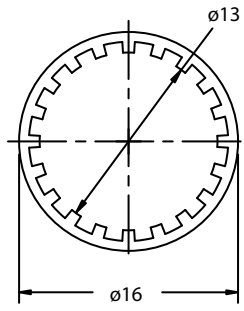
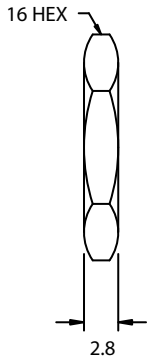
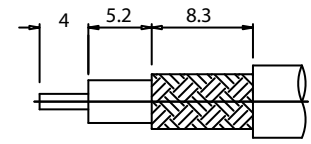

RECOMMENDED CABLE STRIPPING DIM'S

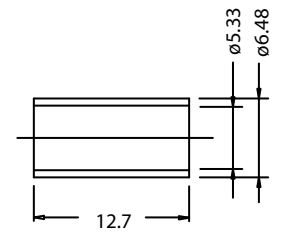

DESCRIPTION	MATERIAL	FINISH	DIMENSIONS ARE IN MILLIMETERS UNLESS OTHERWISE SPECIFIED TOLERANCES ARE:	APPROVALS	DATE	CONNEX Connector Corporation			
						TITLE TNC BULKHEAD CRIMP JACK REVERSED POLARIZED (FOR RG-58/U)			
1	BODY	BRASS	NICKEL	DRAWN G.R.S.	05/05/97	SIZE	FSCM NO.	DWG. NO.	REV.
2	INSULATOR	TEFLON	NATURAL			CHECKED	A	99001	122160-RP.DWG
3	CONTACT PIN	PHOS. BRONZE	GOLD	ISSUED		SCALE	PART NO.	SHEET	
4	FERRULE	COPPER	NICKEL			2:1	122160	1 OF 1	
5	GASKET	RUBBER	RED						
6									
7									
8			DO NOT SCALE DRAWING						