

REV.	DATE	DESCRIPTION
NC	01/20/03	INITIAL RELEASE

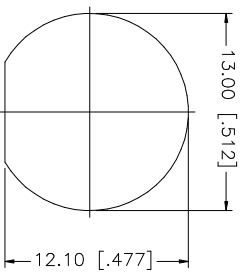

RECOMMENDED
MOUNTING HOLE

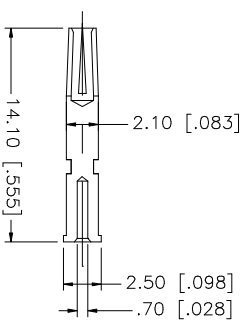
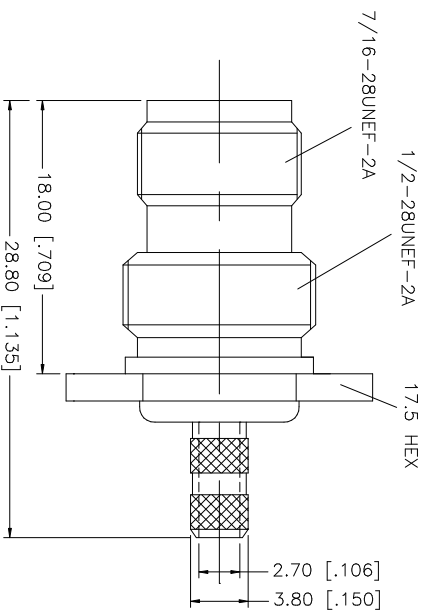
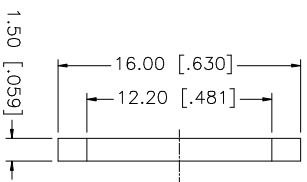
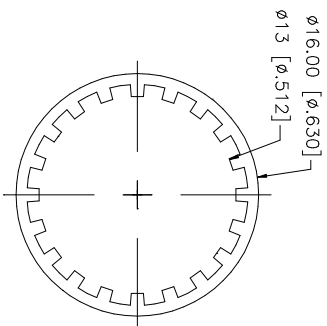
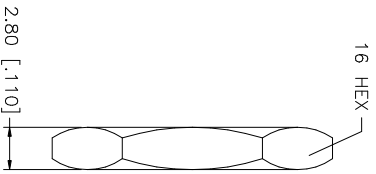
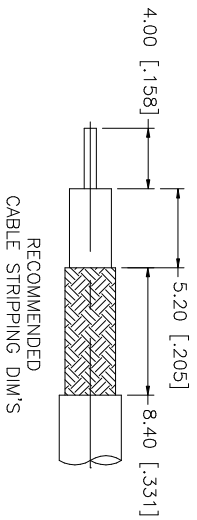
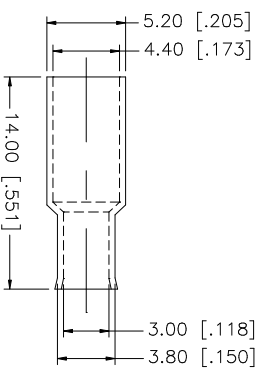
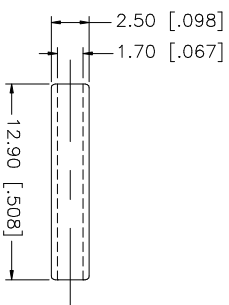

- NOTE:
1. CRIMPED FERRULE
HEX CRIMP SIZE .178"
 2. CRIMPED CONTACT PIN
HEX CRIMP SIZE .068"

QTY	FINISH	MATERIAL	DESCRIPTION
1	NICKEL	COPPER	FERRULE
1	NATURAL	DELRIN	SLEEVE
1	NICKEL	BRASS	HEX NUT
1	NICKEL	BRASS	LOCK WASHER
1	GOLD	PHOS. BRONZE	CONTACT PIN
1	RED	RUBBER	GASKET
1	NICKEL	BRASS	BARREL
1	NATURAL	DELRIN	INSULATOR
1	NICKEL	BRASS	HOUSING/BODY

APPROVALS	DATE
G.R.S.	01/20/03

CAD FILE	DWG. NO.	REV.	NC	SIZE	SCALE
C:/122/122192.DWG	122192.DWG	NC		A	NA

DO NOT SCALE DRAWING
UNLESS OTHERWISE SPECIFIED DIMENSIONS ARE IN MILLIMETERS. DIMENSIONS IN [] ARE IN INCHES AND FOR CUSTOMER REFERENCE ONLY. UNLESS OTHERWISE SPECIFIED TOLERANCES FOR MILLIMETERS ARE: 0.5 - 8mm ± 0.20mm 8 - 30mm ± 0.40mm 30 - 120mm ± 0.50mm UNLESS OTHERWISE SPECIFIED TOLERANCES FOR INCHES ARE: .020 - .315 = ± 0.007" .315 - 1.180 = ± 0.015" 1.180 - 4.724 = ± 0.020"

PART DESCRIPTION	PART NO.
TNC BULKHEAD CRIMP JACK (FOR RG174/u, 188A/u, 316/u CABLE)	122192

Amphenol **Comnex**