



## N COAXIAL CONNECTORS

The Connex N connectors with screw coupling are fully interchangeable with N connectors made to the MIL-C-39012 specification. Designed for use in all systems where very good R.F. and mechanical performance is critical, whether it be at low or high frequencies.

### PLATING FOR INTERMODULATION PROBLEMS

Intermodulation problems have long been a serious concern for the telecommunications market. The elimination of all nickel plating on N series connectors has gone a long way to solve this problem. Connex offers both silver-plated (no nickel undercoat on body or under 30µ" gold center contact) and Nexcote-plated connectors. Nexcote is our trade name for the popular white bronze plating, and is fully compatible with all other commercial tri-alloy platings on the market.

For silver-plated connectors, add "S" to the end of the Connex P/N; for Nexcote, add "NEX".

## ELECTRICAL SPECIFICATIONS

Impedance	50 ohm nominal
Frequency	0-11 GHz
Voltage Rating	1500 Volts peak
Dielectric Withstanding Voltage	2500 Volts rms
VSWR	1.3 max. 0-11 GHz
Contact Resistance	Center contact 1.0 milliohm
	Outer contact 0.2 milliohm
Insulation Resistance	5000 megohms (min)

**\*NOTE:** 75 OHM SERIES CONNECTORS ARE NOT INTERMATEABLE WITH THE 50 OHM SERIES.

## MATERIAL SPECIFICATIONS

PARTS NAME		MATERIAL	FINISH
Center Contact	Male	Brass	Gold or Silver plated
	Female	Phosphor Bronze (nominal) or Beryllium Copper	Gold or Silver plated
Metal parts		Brass	Nickel*
Insulators		Teflon	None
Clamp gaskets		Silicone rubber, Synthetic rubber	None
Crimp ferrules		Annealed copper	Nickel*



## N COAXIAL CONNECTORS

### INTERFACE MATING DIMENSIONS

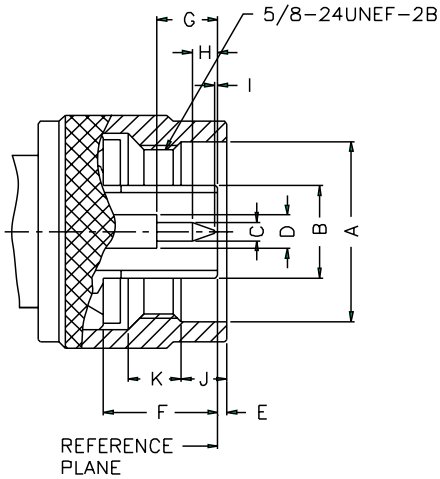

#### PLUG

Letter	Millimeters [Inches]	
	Minimum	Maximum
A	16.00 [.630]	–
B	–	8.38 [.330]
C	1.60 [.063]	1.68 [.066]
D	3.00 [.118]	3.15 [.124]
E	0.41 [.016]	1.52 [.060]
F	10.11 [.398]	10.46 [.412]
G	5.33 [.210]	5.84 [.230]
H	3.30 [.130]	4.32 [.170]
I	0.08 [.003]	–
J	4.01 [.158]	4.27 [.168]
K	4.50 [.177]	5.00 [.197]

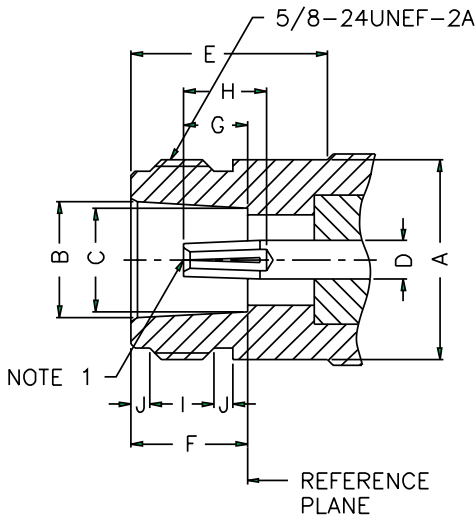

#### JACK

Letter	Millimeters [Inches]	
	Minimum	Maximum
A	–	15.93 [.628]
B	8.53 [.336]	8.74 [.344]
C	8.03 [.316]	8.13 [.320]
D	3.00 [.118]	3.15 [.124]
E	10.72 [.422]	–
F	9.04 [.356]	9.19 [.362]
G	4.75 [.187]	5.26 [.207]
H	5.33 [.210]	–
I	4.37 [.172]	5.13 [.202]
J	1.19 [.047]	1.96 [.077]

NOTE: 1. I.D. TO MEET VSWR AND CONTACT RESISTANCE WHEN MATED WITH 1.6/1.68 MM DIA. PIN.

## N COAXIAL CONNECTORS

All connector bodies, unless otherwise noted, are nickel plated and all contacts are gold plated 3µ".

All insulators are teflon. Silver plating is available. Please contact Connex for samples and quotes.

All dimensions in millimeters and [inches].

### CABLE GROUP LEGEND

01	58/ 58A/ 58C/ 141/ 303/ LMR195™/ B7806A	06A	179/ U DOUBLE BRAIDED	09	B8227/ 89207
01A	55/ 142/ 223/ 400	07	8/ 8A/ 213/ 393	10	.141 SEMI-RIGID/ 402/U
01B	LMR200™/ B7807A	07A	214	11	.085 SEMI-RIGID/ 405/U
02	58 PLENUM/THINNET/ 122U/ B88240/ B89907	07B	8X/ LMR240™/ B7808A	12	.250 SEMI-RIGID
03	59/ 62/ 140/ 210	07C	B9913/ LMR400™/ B7810A/ B8214	13	.047 SEMI-RIGID/ B1674A
03A	59/ U-20AWG	07D	B89913	14	178/ 196
04	59/ U PLENUM	07E	11	15	B8281/ B9231/ B9141
04A	59/ U PLENUM-20AWG	07F	11/ U-14AWG/ B8213/ B9292/ B7731/ B1859A	15A	B88281
05	174/ 188A/ 316/ B7805A	08	6/ 143/ 212	16	180/ 195/ 122/ B8218/ B1865A/ B1855
05A	316/ U DOUBLE BRAIDED	08A	B1694A/ B9248	17	LMR600™
06	179/ 187/ B9221	08B	6 PLENUM/ B1695A	18	AT&T734A/ B1505A
				19	AT&T735A/ B735A1

## CRIMP/SOLDER ATTACHMENTS FOR FLEXIBLE AND SEMI-RIGID CABLE

### STRAIGHT CRIMP PLUG — CAPTIVE CONTACT

P.N.	Cable Group	Finish	Insulation	Impedance	Crimp Tool
172100	01	Nickel	Teflon	50	J
172142	01A	Nickel	Teflon	50	J
172214	01B	Nickel	Teflon	50	J
172161	02	Nickel	Teflon	50	J
172101	03	Nickel	Teflon	50	J
172128	05	Nickel	Teflon	50	B/J
172171	05A	Nickel	Teflon	50	B/J
172102	07	Nickel	Teflon	50	D
172166	07A	Nickel	Teflon	50	D
172135	07B	Nickel	Teflon	50	J
172102H243	07C	Nickel	Teflon	50	L
172249	07D	Nickel	Teflon	50	L
172202	08	Nickel	Teflon	50	E
172281	14	Nickel	Teflon	50	B
172206	17	Nickel	Teflon	50	.610 HEX
172140	(GORE 1839)	Nickel	Teflon	50	E
172290	Nickel	Teflon	50	D	
	RG212/ B9861				
172259	Nickel	Teflon	50	.600 HEX	
	TIMES LMR500™				
172282	Nickel	Teflon	50	N/A	
	1/2" ANDREWS LDF4 HELIAX				
172294	Silver	Teflon	50	N/A	
	1/4" ANDREWS FSJ HELIAX				

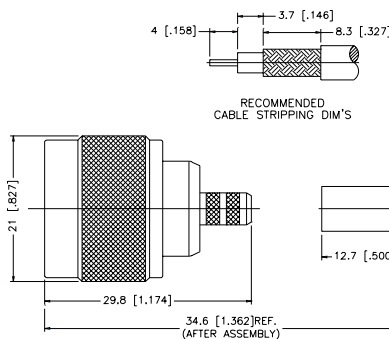

### STRAIGHT SOLDER PLUG — SEMI-RIGID CABLE

P.N.	Cable Group	Finish	Insulation	Impedance	Crimp Tool
172133	10	Nickel/Gold	Teflon	50	N/A
172211	11	Nickel/Gold	Teflon	50	N/A
172139	12	Nickel/Gold	Teflon	50	N/A

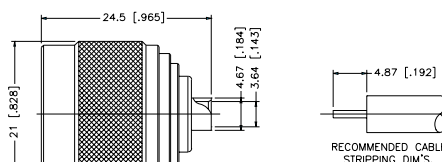

N COAXIAL CONNECTORS

For Reverse Polarized connectors, add RP to standard part number. Contact Connex marketing for availability.  
For Reverse Threaded connectors, add RT to standard part number. Contact Connex marketing for availability.  
For Crimp Tool information, see page 183.

## CRIMP/SOLDER ATTACHMENTS FOR FLEXIBLE AND SEMI-RIGID CABLE

For Cable Group Legend, see page 121

### CRIMP PLUG — ETHERNET CABLE

P.N.	Cable Group	Finish	Insulation	Impedance	Crimp Tool
172156	9880	Nickel	Teflon	50	D
172157	89880	Nickel	Teflon	50	D

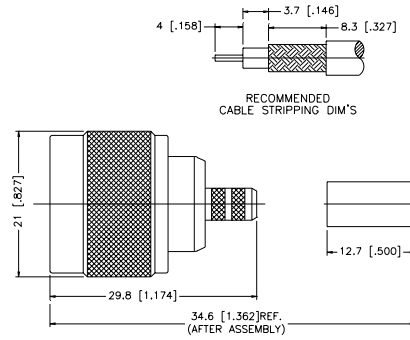

### RIGHT ANGLE CRIMP PLUGS

P.N.	Cable Group	Finish	Insulation	Impedance	Crimp Tool
172177	01	Nickel	Teflon	50	A
172178	01A	Nickel	Teflon	50	A
172215	01B	Nickel	Teflon	50	A
172179	03	Nickel	Teflon	50	A
172180	05	Nickel	Teflon	50	B/J
172245	05A	Nickel	Teflon	50	B/J
172176	07	Nickel	Teflon	50	D
172167	07A	Nickel	Teflon	50	D
172219	07B	Nickel	Teflon	50	A
172176	07C	Nickel	Teflon	50	L
172263	17	Nickel	Teflon	50	.610 HEX
172295	1/4" ANDREWS HELIAX	Silver	Teflon	50	N/A
172252	N/A ANDREWS 3/8" FSJ2-50 SUPER FLEX	Silver	Teflon	50	N/A
172286	1/2" ANDREWS FSJ4-50 SUPER FLEX	Silver	Teflon	50	N/A
172267	LMR500™	Nickel	Teflon	50	.600 HEX

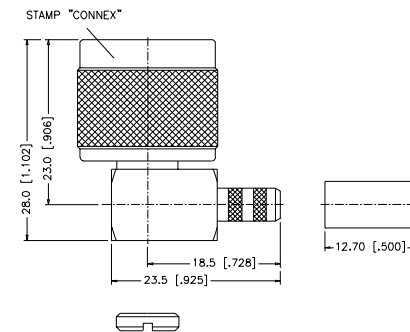

### RIGHT ANGLE SOLDER PLUG — SEMI-RIGID CABLE

P.N.	Cable Group	Finish	Insulation	Impedance	Crimp Tool
172236	10	Nickel/Gold	Teflon	50	N/A
172235	11	Nickel/Gold	Teflon	50	N/A
172266	12	Nickel/Gold	Teflon	50	N/A

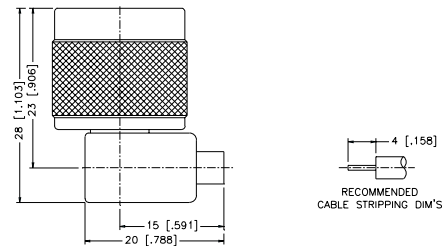

### STRAIGHT CRIMP JACK — CAPTIVE CONTACT

P.N.	Cable Group	Finish	Insulation	Impedance	Crimp Tool
172103	01	Nickel	Teflon	50	J
172147	01A	Nickel	Teflon	50	J
172216	01B	Nickel	Teflon	50	J
172104	03	Nickel	Teflon	50	J
172204	05	Nickel	Teflon	50	B/J
172205	05A	Nickel	Teflon	50	B/J
172105	07	Nickel	Teflon	50	D
172209	07A	Nickel	Teflon	50	D
172148	07B	Nickel	Teflon	50	J
172203	07C	Nickel	Teflon	50	L
172297	07D	Nickel	Teflon	50	L
172207	17	Nickel	Teflon	50	.610 HEX
172268	LMR500™	Nickel	Teflon	50	.600 HEX

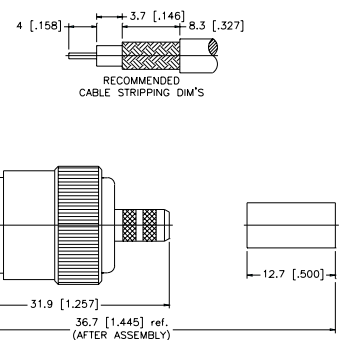
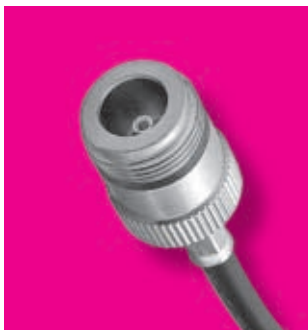

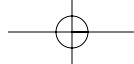

# CRIMP/SOLDER ATTACHMENTS FOR FLEXIBLE AND SEMI-RIGID CABLE

For Cable Group Legend, see page 121

## STRAIGHT SOLDER JACK — SEMI-RIGID CABLE

P.N.	Cable Group	Finish	Insulation	Impedance	Crimp Tool
172238	10	Nickel/Gold	Teflon	50	N/A
172237	11	Nickel/Gold	Teflon	50	N/A

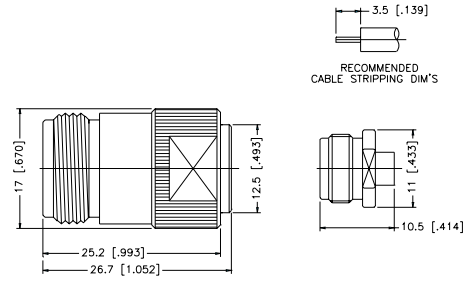

## BULKHEAD CRIMP JACK — CAPTIVE CONTACT — STANDARD CABLES

P.N.	Cable Group	Finish	Insulation	Impedance	Crimp Tool
172106	01	Nickel	Teflon	50	J
172132	01A	Nickel	Teflon	50	J
172217	01B	Nickel	Teflon	50	J
172192	02	Nickel	Teflon	50	J
172107	03	Nickel	Teflon	50	J
172129	05	Nickel	Teflon	50	B
172221	05	Nickel	Teflon	50	B
FRONT MOUNT					
172165	05A	Nickel	Teflon	50	B
172108	07	Nickel	Teflon	50	D
172168	07A	Nickel	Teflon	50	D
172149	07B	Nickel	Teflon	50	J
172220	07C	Nickel	Teflon	50	L
172264	17	Nickel	Teflon	50	.610 HEX
172269	LMR500™	Nickel	Teflon	50	.600 HEX

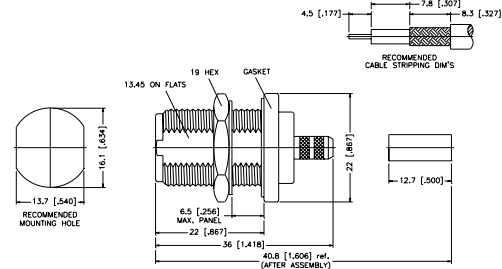
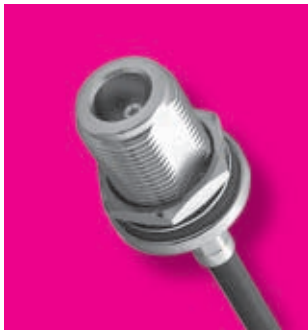

## BULKHEAD SOLDER JACK — SEMI-RIGID CABLE

P.N.	Cable Group	Finish	Insulation	Impedance	Crimp Tool
172137	10	Nickel/Gold	Teflon	50	N/A
172258	10	Nickel/Gold	Teflon	50	N/A
FRONT MOUNT					
172138	11	Nickel/Gold	Teflon	50	N/A
172242	11	Nickel/Gold	Teflon	50	N/A
FRONT MOUNT					
172153	12	Nickel/Gold	Teflon	50	N/A

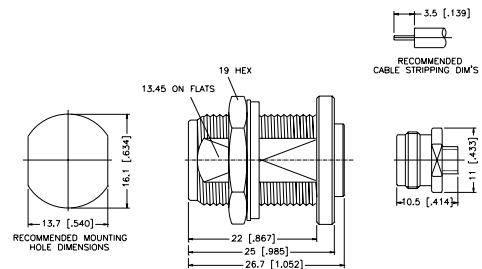

## BULKHEAD CRIMP JACK — ETHERNET CABLE

P.N.	Cable Group	Finish	Insulation	Impedance	Crimp Tool
172158	9880	Nickel	Teflon	50	D
172159	89880	Nickel	Teflon	50	D

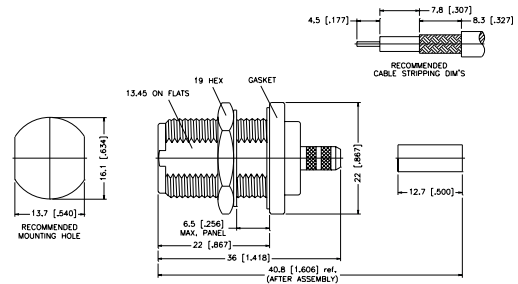
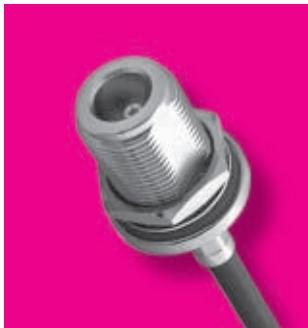

CRIMP ON

For Reverse Polarized connectors, add RP to standard part number. Contact Connex marketing for availability.  
 For Reverse Threaded connectors, add RT to standard part number. Contact Connex marketing for availability.  
 For Crimp Tool information, see page 183.

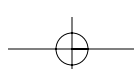
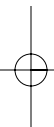

## CRIMP/SOLDER ATTACHMENTS FOR FLEXIBLE AND SEMI-RIGID CABLE

For Cable Group Legend, see page 121

### BULKHEAD CLAMP JACK — REAR MOUNT — MINIATURE CABLE

P.N.	Cable Group	Finish	Insulation	Impedance	Crimp Tool
172143	05	Nickel	Teflon	50	N/A
	REAR MOUNT FLATWASHER				
172143-10	05	Nickel	Teflon	50	N/A
	REAR MOUNT STARWASHER				
172274	03	Nickel	Teflon	75	N/A
	REAR MOUNT CLAMP				
172287	—	Silver	Teflon	50	N/A
	ANDREWS 1/2" FSJ4-50 SUPERFLEX				

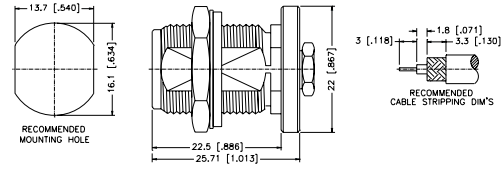
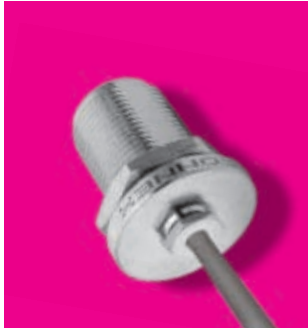

### BULKHEAD CLAMP JACK — FRONT MOUNT — MINIATURE CABLE

P.N.	Cable Group	Finish	Insulation	Impedance	Crimp Tool
172223	05	Nickel	Teflon	50	N/A
172283	05	Nickel	Teflon	50	B

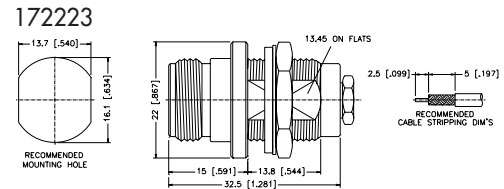

### STRAIGHT CRIMP PANEL JACK — CAPTIVE CONTACT — STANDARD CABLE

P.N.	Cable Group	Finish	Insulation	Impedance	Crimp Tool
172208	01	Nickel	Teflon	50	J
172175	01A	Nickel	Teflon	50	J
172239	01B	Nickel	Teflon	50	J
172173	05	Nickel	Teflon	50	B/J
172265	05	Nickel	Teflon	50	N/A
	CLAMP TERMINATION				
172246	05A	Nickel	Teflon	50	B/J
172182	07	Nickel	Teflon	50	D
172174	07A	Nickel	Teflon	50	D

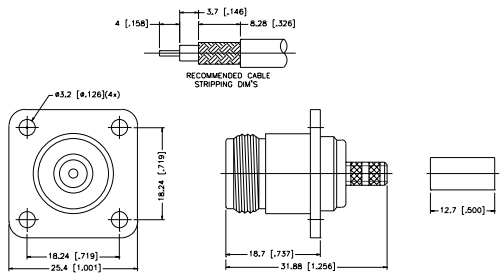
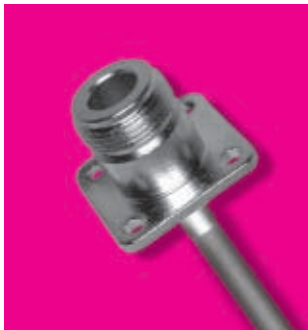

### STRAIGHT SOLDER PANEL JACK — SEMI-RIGID CABLE

P.N.	Cable Group	Finish	Insulation	Impedance	Crimp Tool
172170	10	Nickel/Gold	Teflon	50	N/A
172169	11	Nickel/Gold	Teflon	50	N/A

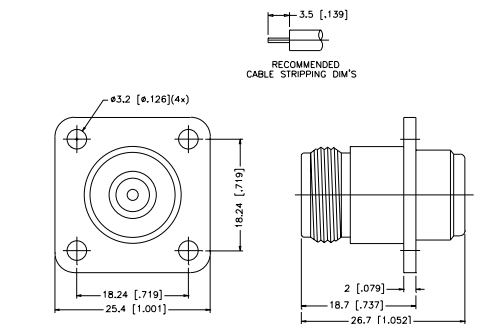

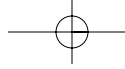

# CLAMP ATTACHMENTS FOR FLEXIBLE CABLE

For Cable Group Legend, see page 121

## STRAIGHT SOLDER PLUG — CAPTIVE CONTACT

P.N.	Cable Group	Finish	Insulation	Impedance	Crimp Tool
172111	01/01A	Nickel	Teflon	50	N/A
172112	03	Nickel	Teflon	50	N/A

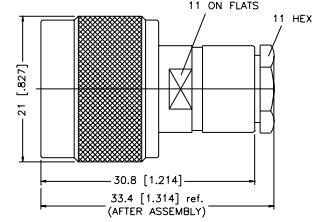
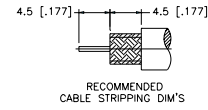

## STRAIGHT SOLDER PLUG — CAPTIVE CONTACT

P.N.	Cable Group	Finish	Insulation	Impedance	Crimp Tool
172113	07/07A	Nickel	Teflon	50	N/A
172113H243	07C	Nickel	Teflon	50	N/A

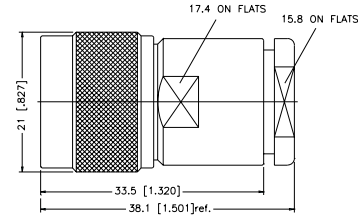
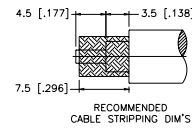
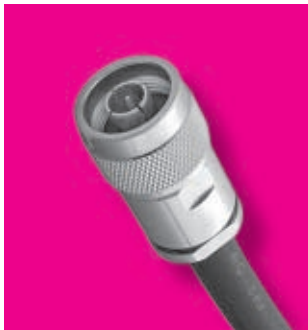

## STRAIGHT SOLDER JACK — CAPTIVE CONTACT

P.N.	Cable Group	Finish	Insulation	Impedance	Crimp Tool
172114	01	Nickel	Teflon	50	N/A
172115	03	Nickel	Teflon	50	N/A

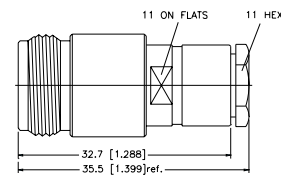
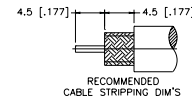

## STRAIGHT SOLDER JACK — CAPTIVE CONTACT

P.N.	Cable Group	Finish	Insulation	Impedance	Crimp Tool
172116	07	Nickel	Teflon	50	N/A

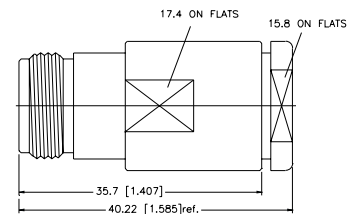
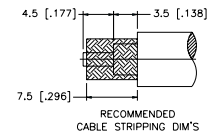
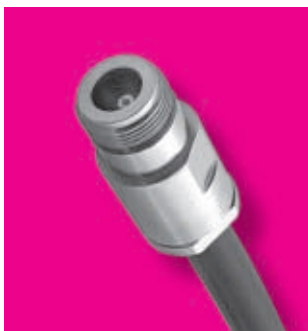

For Reverse Polarized connectors, add RP to standard part number. Contact Connex marketing for availability.  
For Reverse Threaded connectors, add RT to standard part number. Contact Connex marketing for availability.  
For Crimp Tool information, see page 183.

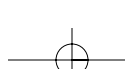

# BULKHEAD MOUNT SOLDER RECEPTACLES

For Cable Group Legend, see page 121

## BULKHEAD RECEPTACLE — FRONT MOUNT

P.N.	Cable Group	Finish	Insulation	Impedance	Crimp Tool
172185	N/A	Nickel	Teflon	50	N/A

Remark: Non-hermetic

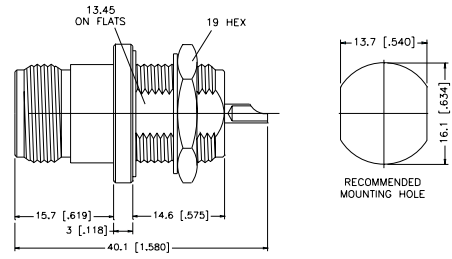

## BULKHEAD RECEPTACLE — FRONT MOUNT

P.N.	Cable Group	Finish	Insulation	Impedance	Crimp Tool
172255	N/A	Nickel	Teflon	50	N/A
172255-10	N/A	Nickel	Teflon	50	N/A
DOUBLE "D" MOUNT					

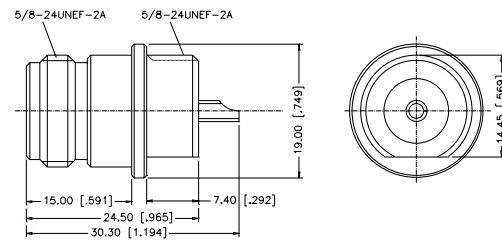

## BULKHEAD RECEPTACLE — BNC MOUNTING HOLE — FRONT MOUNT

P.N.	Cable Group	Finish	Insulation	Impedance	Crimp Tool
172270	N/A	Nickel	Teflon	50	N/A

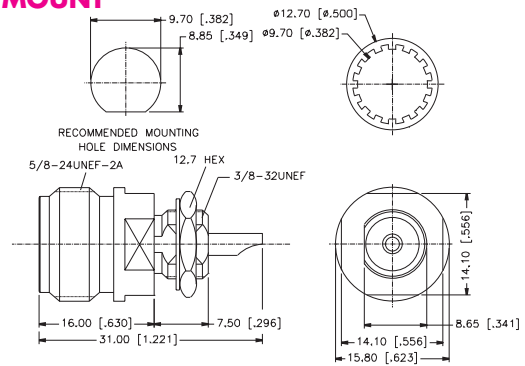

## RIGHT ANGLE PANEL RECEPTACLE

P.N.	Cable Group	Finish	Insulation	Impedance	Crimp Tool
172277	N/A	Nickel	Teflon	50	N/A

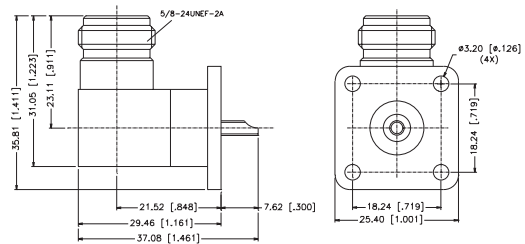



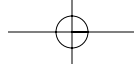

# PANEL MOUNT/SOLDER RECEPTACLES

For Cable Group Legend, see page 121

## PANEL RECEPTACLE JACK — EXPOSED TFE TYPE

P.N.	Cable Group	Finish	Insulation	Impedance	Crimp Tool
172117	N/A	Nickel	Teflon	50	N/A
172189	N/A	Nickel	Teflon	50	N/A

Remark: With gasket. Extended Teflon insulation available in various lengths. Contact Connex marketing department for part number and availability.

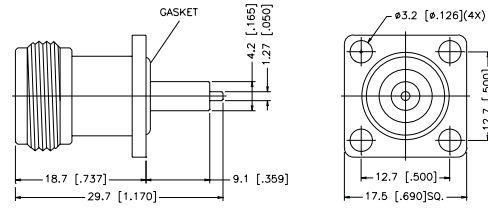

## PANEL RECEPTACLE PLUG — EXPOSED TFE TYPE

P.N.	Cable Group	Finish	Insulation	Impedance	Crimp Tool
172260	N/A	Nickel	Teflon	50	N/A

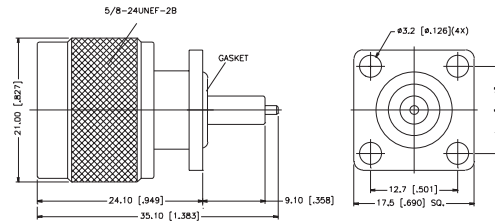

## PANEL RECEPTACLE PLUG — SOLDER POT TERMINAL

P.N.	Cable Group	Finish	Insulation	Impedance	Crimp Tool
172118	N/A	Nickel	Teflon	50	N/A

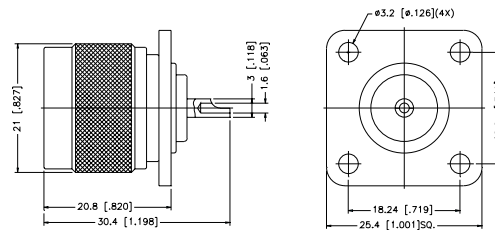

## PANEL RECEPTACLE JACK — SOLDER POT TERMINAL

P.N.	Cable Group	Finish	Insulation	Impedance	Crimp Tool
172119	N/A	Nickel	Teflon	50	N/A
172210	N/A	Nickel	Teflon	50	N/A
CAPTIVE CENTER CONTACT					
172181	N/A	Nickel	Teflon	50	N/A
FLUSH REAR					

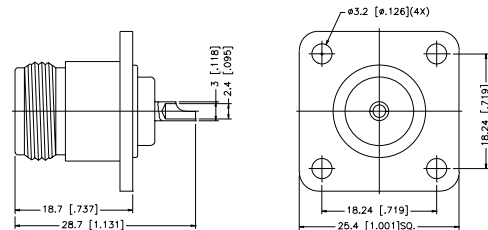

For Reverse Polarized connectors, add RP to standard part number. Contact Connex marketing for availability.  
 For Reverse Threaded connectors, add RT to standard part number. Contact Connex marketing for availability.  
 For Crimp Tool information, see page 183.

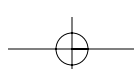

## PANEL MOUNT/SOLDER RECEPTACLES

For Cable Group Legend, see page 121

### PANEL RECEPTACLE — ROUND FLANGE

P.N.	Cable Group	Finish	Insulation	Impedance	Crimp Tool
172201	N/A	Nickel	Teflon	50	N/A

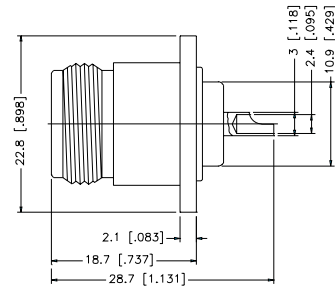

### PANEL RECEPTACLE PLUG — SLOT TERMINAL

P.N.	Cable Group	Finish	Insulation	Impedance	Crimp Tool
172120	N/A	Nickel	Teflon	50	N/A
Slot width: 0.3 mm, 0.5 mm, 0.7 mm, 0.9 mm					
172196	N/A	Nickel	Teflon	50	N/A
FLAT TAB					
172222	N/A	Nickel	Teflon	50	N/A
EXTENDED TEFLON BLUNT POST					

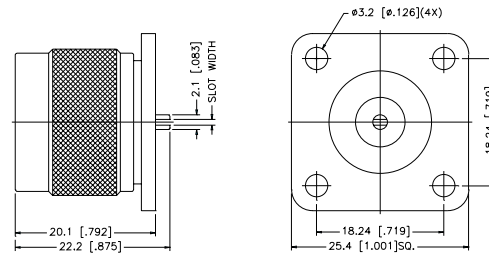

### PANEL RECEPTACLE JACK — SLOT TERMINAL

P.N.	Cable Group	Finish	Insulation	Impedance	Crimp Tool
172121	N/A	Nickel	Teflon	50	N/A
Slot width: 0.3 mm, 0.5 mm, 0.7 mm, 0.9 mm					
172186	N/A	Nickel	Teflon	50	N/A
2-HOLE FLANGE BLUNT POST					
172155	N/A	Nickel	Teflon	50	N/A
.5 FLANGE SLOTTED POST					
172146	N/A	Nickel	Teflon	50	N/A
.118 DIAMETER CONTACT SLOTTED POST					
172232	N/A	Nickel	Teflon	50	N/A
.690 FLANGE SLOTTED POST					

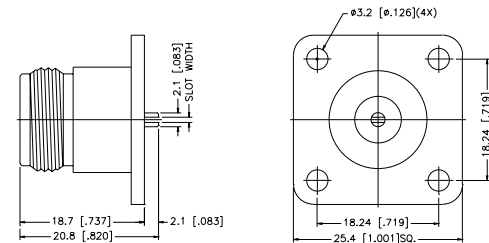

### PANEL RECEPTACLE JACK — EXTENDED TEFLON

P.N.	Cable Group	Finish	Insulation	Impedance	Crimp Tool
172228	N/A	Nickel	Teflon	50	N/A

Remark: Consult Connex Marketing for various lengths available

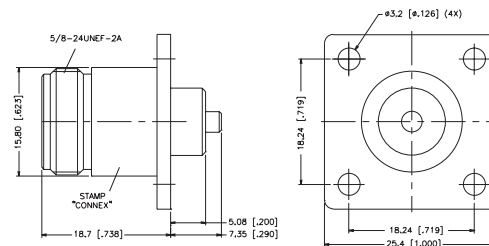

# PANEL MOUNT/SOLDER RECEPTACLES

For Cable Group Legend, see page 121

## PANEL RECEPTACLE — EXTENDED BODY

P.N.	Cable Group	Finish	Insulation	Impedance	Crimp Tool
172187	N/A	Nickel	Teflon	50	N/A
			BLUNT POST		
172218	N/A	Nickel	Teflon	50	N/A
			EXTENDED TEFLON		



172187

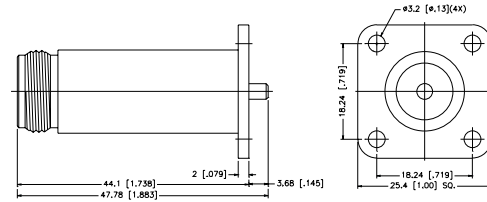

172218

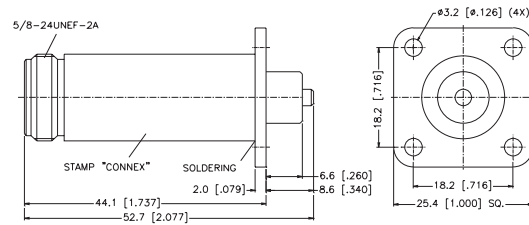

## PANEL RECEPTACLE — EXTENDED BODY — POST CONTACT

P.N.	Cable Group	Finish	Insulation	Impedance	Crimp Tool
172190	N/A	Nickel	Teflon	50	N/A

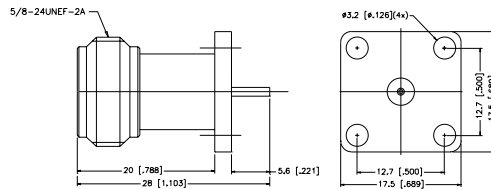

## PANEL RECEPTACLE — TAB POST

P.N.	Cable Group	Finish	Insulation	Impedance	Crimp Tool
172195	N/A	Nickel	Teflon	50	N/A

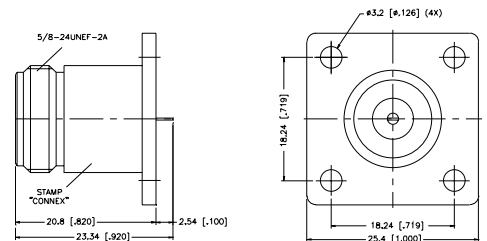

For Reverse Polarized connectors, add RP to standard part number. Contact Connex marketing for availability.  
 For Reverse Threaded connectors, add RT to standard part number. Contact Connex marketing for availability.  
 For Crimp Tool information, see page 183.

## PANEL MOUNT/SOLDER RECEPTACLES

For Cable Group Legend, see page 121

### PRINTED CIRCUIT BOARD RECEPTACLE

P.N.	Cable Group	Finish	Insulation	Impedance	Crimp Tool
172243	N/A	Nickel PCB LEGS, BRIGHT TIN	Teflon	50	N/A

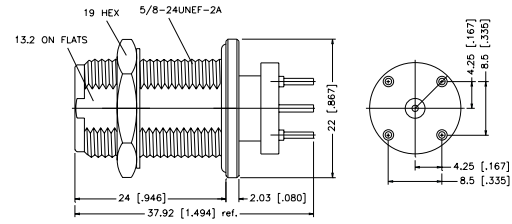

### PRESS FIT RECEPTACLE

P.N.	Cable Group	Finish	Insulation	Impedance	Crimp Tool
172248	N/A	Nickel	Teflon	50	N/A

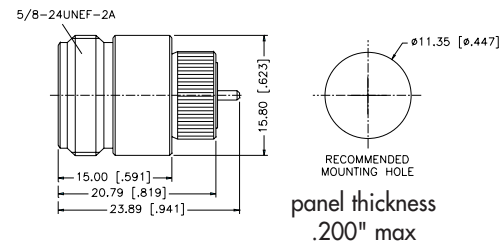

### RIGHT ANGLE PRINTED CIRCUIT BOARD RECEPTACLE

P.N.	Cable Group	Finish	Insulation	Impedance	Crimp Tool
172234	N/A	Tin Lead	Teflon	50	N/A

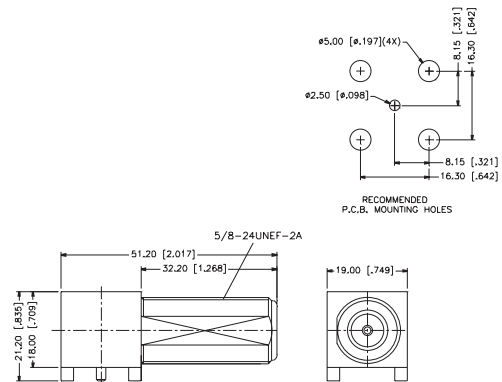

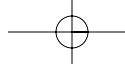

## FEEDTHROUGH ADAPTERS

For Cable Group Legend, see page 121

### PLUG-TO-PLUG ADAPTER

P.N.	Cable Group	Finish	Insulation	Impedance	Crimp Tool
172122	N/A	Nickel	Teflon	50	N/A
172212 RP	N/A	Nickel	Teflon	50	N/A
N PLUG REVERSE POLARIZED TO N JACK					
172213 RP	N/A	Nickel	Teflon	50	N/A
N JACK REVERSE POLARIZED TO N PLUG					

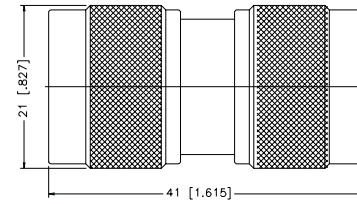
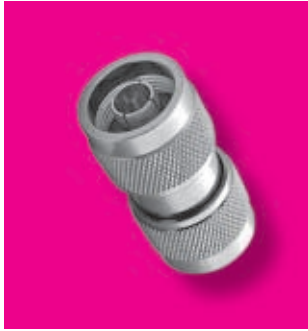

### JACK-TO-JACK ADAPTER

P.N.	Cable Group	Finish	Insulation	Impedance	Crimp Tool
172123	N/A	Nickel	Teflon	50	N/A
172123-10	N/A	Nickel	Teflon	50	N/A
FULLY-THREADED BODY 1.75" LONG					

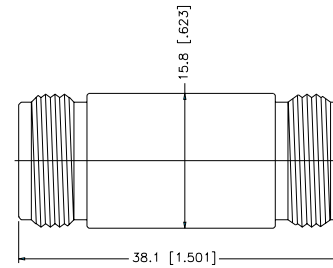

### PLUG-TO-JACK ADAPTER

P.N.	Cable Group	Finish	Insulation	Impedance	Crimp Tool
172276	N/A	Nickel	Teflon	50	N/A

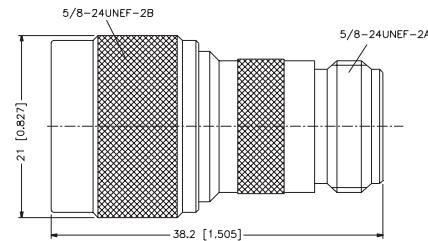

### JACK-TO-JACK BULKHEAD ADAPTER

P.N.	Cable Group	Finish	Insulation	Impedance	Crimp Tool
172124	N/A	Nickel	Teflon	50	N/A

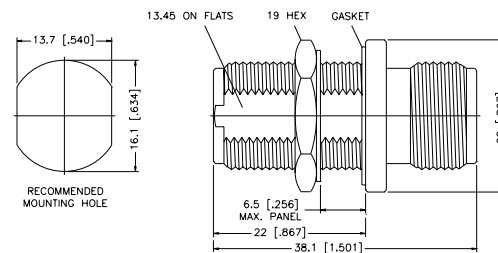

For Reverse Polarized connectors, add RP to standard part number. Contact Connex marketing for availability.  
 For Reverse Threaded connectors, add RT to standard part number. Contact Connex marketing for availability.  
 For Crimp Tool information, see page 183.

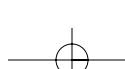

## FEEDTHROUGH ADAPTERS

For Cable Group Legend, see page 121

### JACK-TO-JACK PANEL ADAPTER

P.N.	Cable Group	Finish	Insulation	Impedance	Crimp Tool
172278	N/A	Nickel	Teflon	50	N/A
172278-10	N/A	Nickel EXTENDED BODY	Teflon	50	N/A



172278

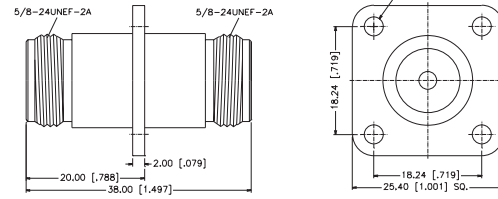

172278-10

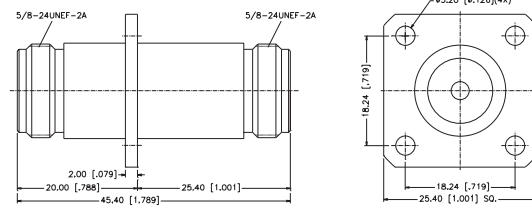

## TEE ADAPTERS/ANGLE ADAPTERS

### TEE ADAPTER — JACK-TO-PLUG-TO-JACK

P.N.	Cable Group	Finish	Insulation	Impedance	Crimp Tool
172125	N/A	Nickel	Teflon	50	N/A

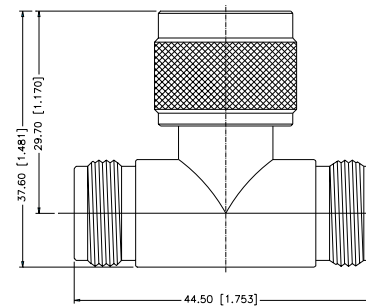

### TEE ADAPTER — JACK-TO-JACK-TO-JACK

P.N.	Cable Group	Finish	Insulation	Impedance	Crimp Tool
172127	N/A	Nickel	Teflon	50	N/A

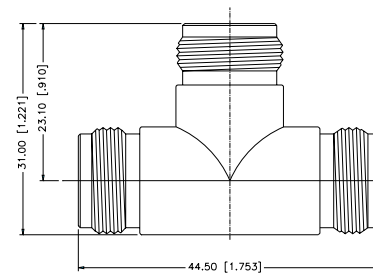

## TEE ADAPTERS/ANGLE ADAPTERS

For Cable Group Legend, see page 121

### TEE ADAPTER — PLUG-TO-JACK-TO-JACK

P.N.	Cable Group	Finish	Insulation	Impedance	Crimp Tool
172233	N/A	Nickel	Teflon	50	N/A

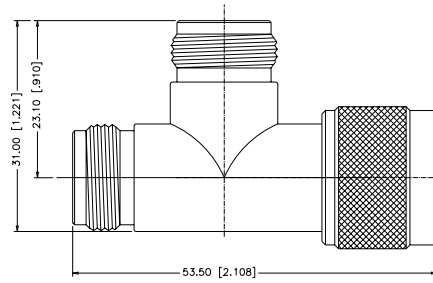

### ANGLE ADAPTER — PLUG-TO-JACK

P.N.	Cable Group	Finish	Insulation	Impedance	Crimp Tool
172126	N/A	Nickel	Teflon	50	N/A
172193	N/A	Nickel	Teflon	50	N/A
HIGH PERFORMANCE					

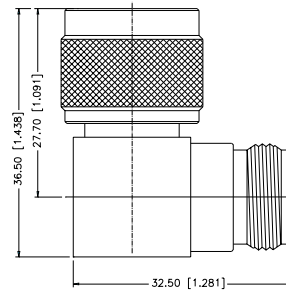

### ANGLE ADAPTER — PLUG-TO-PLUG

P.N.	Cable Group	Finish	Insulation	Impedance	Crimp Tool
172261	N/A	Nickel	Teflon	50	N/A

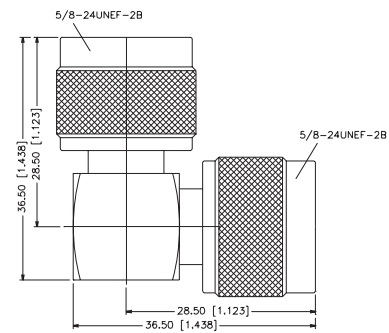

For Reverse Polarized connectors, add RP to standard part number. Contact Connex marketing for availability.  
 For Reverse Threaded connectors, add RT to standard part number. Contact Connex marketing for availability.  
 For Crimp Tool information, see page 183.

ACCESSORIES

For Cable Group Legend, see page 121

N MALE CAP & CHAIN

P.N.	Cable Group	Finish	Insulation	Impedance	Crimp Tool
202102	N/A	Nickel	N/A	N/A	N/A

Remark: Chain length 100 [3.94]

