

Amphenol

Amphenol-Tuchel Electronics GmbH

eco|mate^m Circular Connectors



easier and quicker to assemble



|mate by Amphenol

The Company

Amphenol-Tuchel Electronics GmbH is a member of the USA based Amphenol Corporation. With our own global presence we offer our customers exceptional technical support and worldwide service in the areas of development, production and distribution. Amphenol-Tuchel Electronics GmbH has a successful history as a partner to our customers and sets standards for connector technology.



Quality

From the beginning of the development process, Amphenol-Tuchel Electronics GmbH gives quality considerations the top priority. Meeting customer requirements is the main focus of the product development process.

Interdisciplinary project teams with diverse backgrounds from marketing, product engineering and production guarantee the development and production of robust and reliable connector solutions.

Our quality assessment begins with the initial contact to the customer and extends through the life of the product. A satisfied customer is the measure of our success.

We strive to use environmentally friendly processes that minimize the waste of natural resources and introduction of toxins into the environment.

Certifications: TS 16949
 ISO 14001
 ISO 9000:2000

General information

We reserve the right to change the design due to improvement in quality, development or production requirements.

This catalogue must not be used in any form or manner without our prior approval in writing (Copyright Law, Fair Trading Law, Civil Code).

This release replaces all former releases.

eco|mate is a registered trademark. Usage or modification is not allowed without written permission of Amphenol-Tuchel.

eco | mate^m

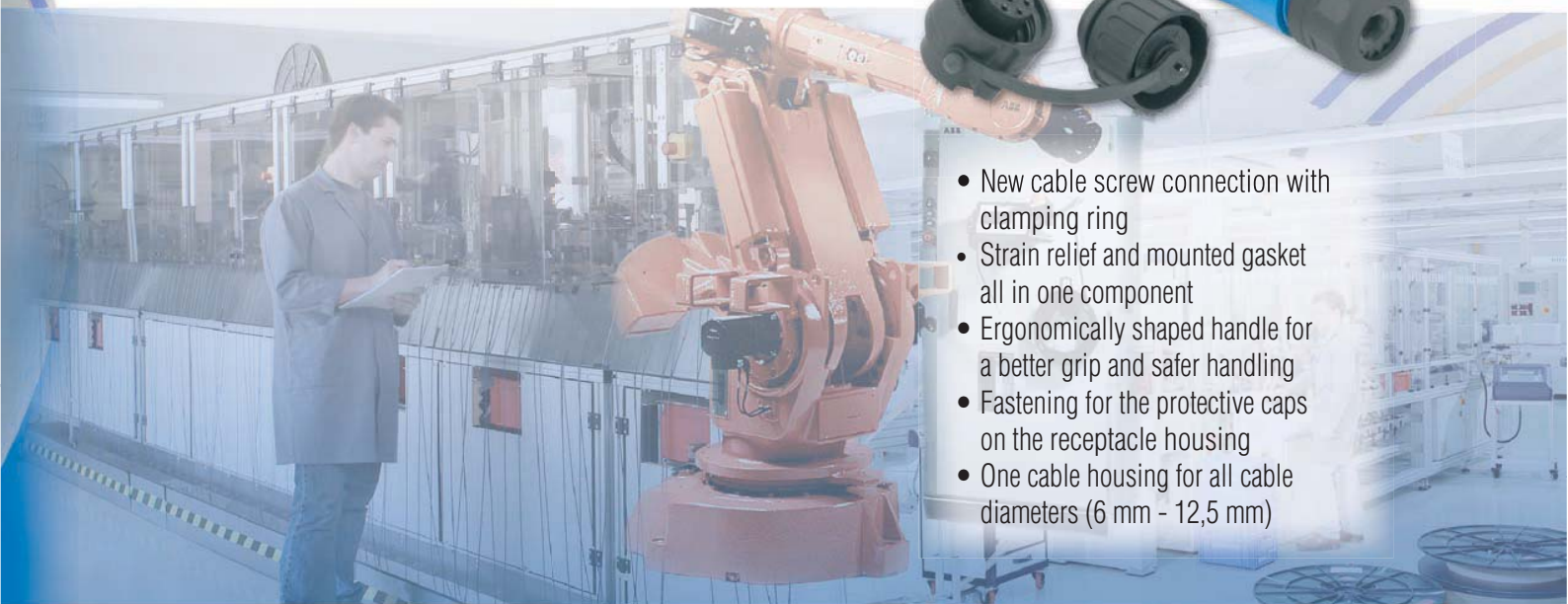

- New cable screw connection with clamping ring
- Strain relief and mounted gasket all in one component
- Ergonomically shaped handle for a better grip and safer handling
- Fastening for the protective caps on the receptacle housing
- One cable housing for all cable diameters (6 mm - 12,5 mm)

Content	Page
General Information	2
Product Description	5
Technical Data	6
Derating Curves / Order Information	7
Products 	8
Crimp Contacts	10
Accessories	11
Mounting Instructions	12
Technical Information	13
Remarks / Safety Classification	16
Summary of Part Numbers	17

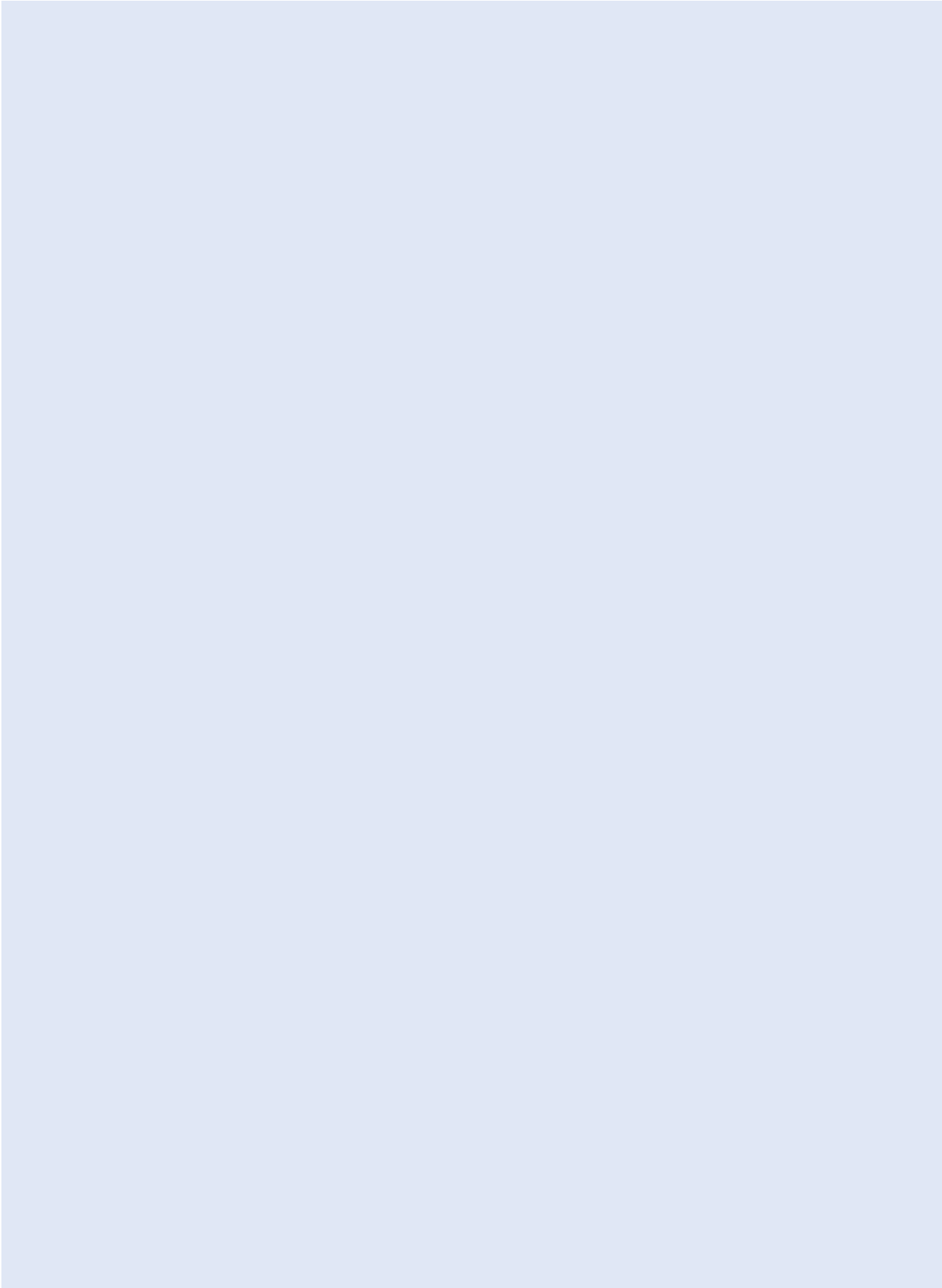



Product Description

In design and conception the eco|mate^m program meets the high requirements for applications in industrial technology. Easy operation, reduced dimensions and a more robust design to withstand harsh conditions are only a few of the features of the series.

The connector's main area of application is in the fields of plant construction and machine building. The connector is principally used for measuring and controlling applications such as the control technology for motive engineering, but may also be used for medical. The series is comprised of a large selection of housings and shapes, as well as models with screw, solder and crimp termination.

Features:





- Circular Connectors with 3+PE and 6+PE contacts
- Housing components made from premium molding material
- Cable housing straight or angled
- Vibration safe connection through stable and non-sensitive screw locking
- Protection class IP 65/67 in mated condition in accordance with DIN EN 60526
- Clamping ring or internal strain relief

Advantages:

- Quick and easy assembly
- Screwed cable gland with clamping ring
- Strain relief and mounted gasket all in one component
- Cable housing, straight or angled, for the cable diameter 6 - 12,5 mm
- Robust thread for the screwed cable gland
- Ergonomically designed product range for safe handling, even under harsh working conditions
- Pre-loaded ground contact
- Fastening for the protective caps on the housing of the receptacles
- The eco|mate^m program is compatible and interchangeable with the C16-1 series



Additional standards:

- The 6+PE model corresponds to DIN 9684-1 interface to the signal transmission on agricultural machines and tractors

Testhouse		Characteristics	Approval Number
VDE		3+PE, 400 V, 16 A 6+PE, 250 V, 10 A	1781 1780
SEV		3+PE, 400 V, 16 A 6+PE, 250 V, 6 A	00.0394
UL ¹⁾		3+PE, 250 V, 12 A (400V, 16A requested) 6+PE, 250 V, 8 A (250V, 13A requested)	E 63093
CSA		3+PE, 250 V, 12 A 6+PE, 250 V, 8 A (Solder version) 6+PE, 250 V, 15 A (Crimp version)	48932
German Llyod		3+PE, 250 V, 16 A 6+PE, 50 V, 8 A	14108 / 84

In general approvals refer to versions of the connector series. Test report upon request.

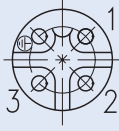
¹⁾ Please refer to „Conditions of Acceptability“

General Characteristics	Standard	Characteristics		
Number of contacts		3 + PE	6 + PE	
				
Electrical Characteristics		screw type	solder type	crimp type
Rated voltage	DIN EN 60664-1 ¹⁾	400 V	250 V	250 V
Rated impulse withstand voltage	DIN EN 60664-1 ¹⁾	6000 V	4000 V	
Pollution degree	DIN EN 60664-1 ¹⁾	3	3	
Installation (overvoltage) category	DIN EN 60664-1 ¹⁾	III	III	
Material group	DIN EN 60664-1 ¹⁾	II	II	
Current carrying capacity	DIN EN 60512-5-2, Test 5b	16 A / + 55 °C	13 A / + 55 °C	
Insulation resistance	DIN EN 60512-3-1, Test 3a	≥ 10 ⁸ Ω	≥ 10 ⁸ Ω	
Contact resistance	DIN EN 60512-2-1, Test 2a	≤ 5 m Ω	≤ 5 m Ω	
Climatic Characteristics				
Climatic category	DIN EN 60068-1	40 / 100 / 56	40 / 125 / 56	
Operating temperature		-40°C ... +100°C	-40°C ... +125°C	
Mechanical Characteristics				
Degree of protection	DIN EN 60529	IP 65 / IP 67		
Insertion and withdrawal force	DIN EN 60512-13-2, Test 13b	≤ 15 N	≤ 30 N	
Mechanical operation	DIN EN 60512, Test 9a	≥ 500 mating cycles		
Materials				
Housing material		PA 6.6 / PA 6		
Dielectric material		PA 6.6 / PA 6		
Gasket material		Neoprene		
Contact plating		silver plated / gold plated		
Other Characteristics				
Termination technique		screw	solder	crimp
Wire gauge / AWG		0,75 - 2,5 mm ² AWG 20 - 14	max. 0,75 mm ² AWG 20	0,14 - 1,5 mm ² AWG 26-16
Flammability	UL 94	V0		
Locking system		round thread		

¹⁾ DIN EN 60664-1 ≙ VDE 0110-1 ≙ IEC 60664-1



The stated technical values refer to the use as connector without breaking capacity (COC).

If these components are used as plug and socket device a reduced current carrying capacity has to be considered. The characteristics have to be requested from the manufacturer.

Derating Curves

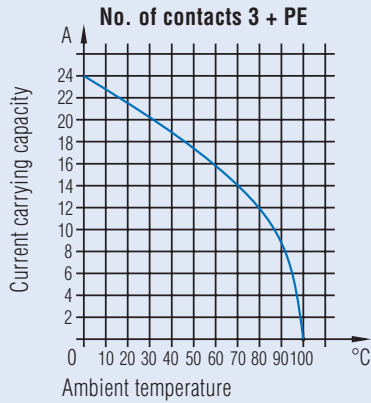

all contacts under load
wire gauge 2,5 mm², 14 AWG

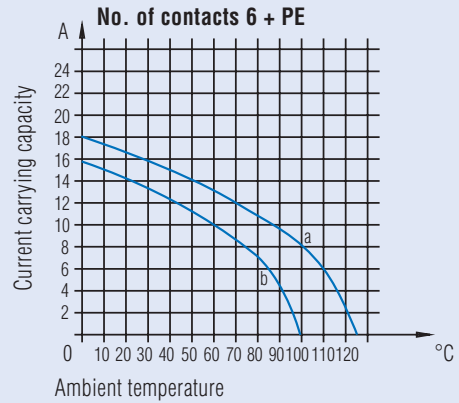

all contacts under load
a) wire gauge 1,5 mm², 16 AWG, stamped crimp contacts
wire gauge 0,75 mm², 20 AWG, stamped solder contacts
b) wire gauge 0,75 mm², turned solder contacts

Order Information

Color coding

Upon request the coupling ring of the plugs and the housings of the receptacles can be delivered in the colors red, green, blue, yellow and grey.
Min order quantity = 1000 pcs. per type.

Mechanical coding

Achieved with special coding pins which are inserted into contact cavities.
Min. order quantity = 1000 pcs. per type.

Crimp version

Order number do not include crimp contacts. Please order separately (see page 10).

Crimp tooling

Ask for our catalogue "Tools"

Product Number Configuration

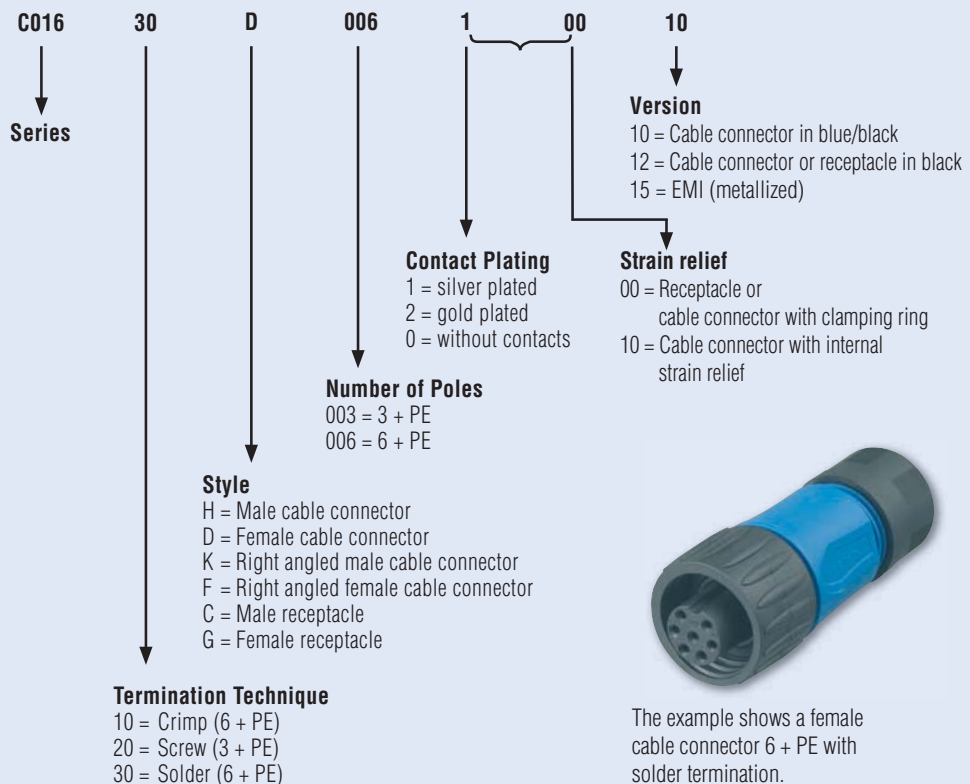

The example shows a female cable connector 6 + PE with solder termination.

Male cable connector straight, with internal strain relief clamp and/or clamping ring, cable diameter 6 - 12,5 mm

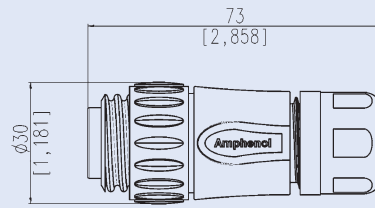

No. of contacts	Termination technique	Back shell color	Part number Strain relief with clamping ring Contact plating		Part number Internal strain relief + clamping ring Contact plating	
			Silver plated	Gold plated	Silver plated	Gold plated
3 + PE	screw	blue	C016 20H003 100 10	C016 20H003 200 10	C016 20H003 110 10	C016 20H003 210 10
3 + PE	screw	black	C016 20H003 100 12	C016 20H003 200 12	C016 20H003 110 12	C016 20H003 210 12
6 + PE	solder	blue	C016 30H006 100 10	C016 30H006 200 10	C016 30H006 110 10	C016 30H006 210 10
6 + PE	solder	black	C016 30H006 100 12	C016 30H006 200 12	C016 30H006 110 12	C016 30H006 210 12
6 + PE	crimp ¹⁾	blue	C016 10H006 000 10	C016 10H006 000 10	C016 10H006 010 10	C016 10H006 010 10
6 + PE	crimp ¹⁾	black	C016 10H006 000 12	C016 10H006 000 12	C016 10H006 010 12	C016 10H006 010 12

Male cable connector right angled, strain relief with clamping ring cable diameter 6 - 12,5 mm

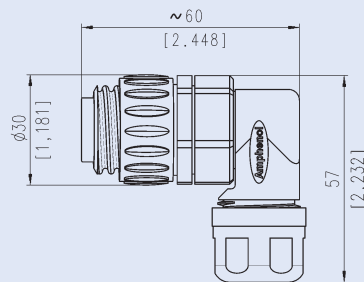

No. of contacts	Termination technique	Back shell color	Part number Strain relief with clamping ring Contact plating	
			Silver plated	Gold plated
3 + PE	screw	blue	C016 20K003 100 10	C016 20K003 200 10
3 + PE	screw	black	C016 20K003 100 12	C016 20K003 200 12
6 + PE	solder	blue	C016 30K006 100 10	C016 30K006 200 10
6 + PE	solder	black	C016 30K006 100 12	C016 30K006 200 12
6 + PE	crimp ¹⁾	blue	C016 10K006 000 10	C016 10K006 000 10
6 + PE	crimp ¹⁾	black	C016 10K006 000 12	C016 10K006 000 12

Female receptacle, screw termination (3+PE), solder termination or crimp version (6+PE)

Dimension A

Screw version: 13,5 mm

Solder version: 12,5 mm

Crimp version: 16,5 mm

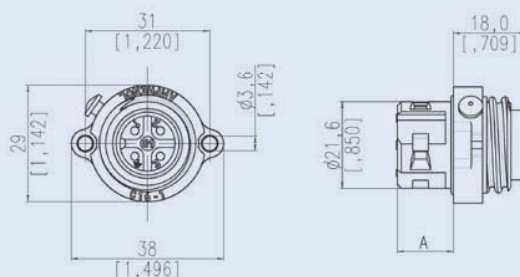

No. of contacts	Termination technique	Back shell color	Part number Contact plating	
			Silver plated	Gold plated
3 + PE	screw	black	C016 20G003 100 12	C016 20G003 200 12
6 + PE	solder	black	C016 30G006 100 12	C016 30G006 200 12
6 + PE	crimp ¹⁾	black	C016 10G006 000 12	C016 10G006 000 12

Mounting cut-out²⁾

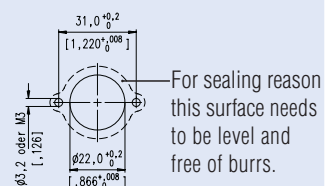

¹⁾ Crimp contacts see page 10 / Crimp tooling see catalogue "Tools". ²⁾ Mounting hole $\varnothing 22$ without chamfer, suitable sealing for screws is necessary.

Female cable connector straight, with internal strain relief clamp and/or clamping ring, cable diameter 6 - 12,5 mm

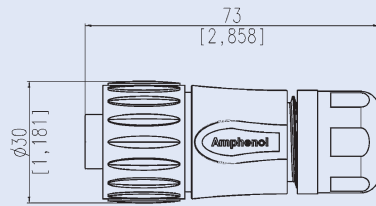

No. of contacts	Termination technique	Back shell color	Part number Strain relief with clamping ring Contact plating		Part number Internal strain relief + clamping ring Contact plating	
			Silver plated	Gold plated	Silver plated	Gold plated
3 + PE	screw	blue	C016 20D003 100 10	C016 20D003 200 10	C016 20D003 110 10	C016 20D003 210 10
3 + PE	screw	black	C016 20D003 100 12	C016 20D003 200 12	C016 20D003 110 12	C016 20D003 210 12
6 + PE	solder	blue	C016 30D006 100 10	C016 30D006 200 10	C016 30D006 110 10	C016 30D006 210 10
6 + PE	solder	black	C016 30D006 100 12	C016 30D006 200 12	C016 30D006 110 12	C016 30D006 210 12
6 + PE	crimp ¹⁾	blue	C016 10D006 000 10	C016 10D006 000 10	C016 10D006 010 10	C016 10D006 010 10
6 + PE	crimp ¹⁾	black	C016 10D006 000 12	C016 10D006 000 12	C016 10D006 010 12	C016 10D006 010 12

Female cable connector right angled, strain relief with clamping ring cable diameter 6 - 12,5 mm

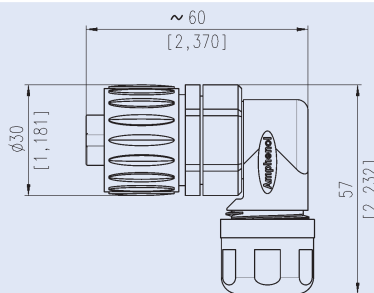

No. of contacts	Termination technique	Back shell color	Part number Strain relief with clamping ring Contact plating	
			Silver plated	Gold plated
3 + PE	screw	blue	C016 20F003 100 10	C016 20F003 200 10
3 + PE	screw	black	C016 20F003 100 12	C016 20F003 200 12
6 + PE	solder	blue	C016 30F006 100 10	C016 30F006 200 10
6 + PE	solder	black	C016 30F006 100 12	C016 30F006 200 12
6 + PE	crimp ¹⁾	blue	C016 10F006 000 10	C016 10F006 000 10
6 + PE	crimp ¹⁾	black	C016 10F006 000 12	C016 10F006 000 12

Male receptacle, screw termination (3+PE), solder termination or crimp version (6+PE)

Dimension A

Screw version: 14,0 mm

Solder version: 12,0 mm

Crimp version: 16,5 mm

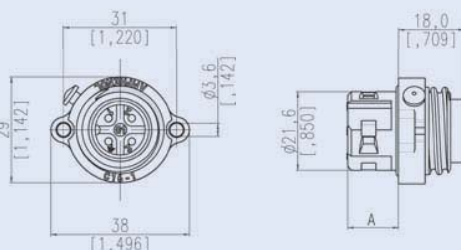

No. of contacts	Termination technique	Back shell color	Part number Contact plating	
			Silver plated	Gold plated
3 + PE	screw	black	C016 20C003 100 12	C016 20C003 200 12
6 + PE	solder	black	C016 30C006 100 12	C016 30C006 200 12
6 + PE	crimp ¹⁾	black	C016 10C006 000 12	C016 10C006 000 12

Mounting cut-out²⁾

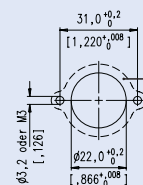

For sealing reason this surface needs to be level and free of burrs.

¹⁾ Crimp contacts see page 10 / Crimp tooling see catalogue "Tools". ²⁾ Mounting hole Ø 22 without chamfer, suitable sealing for screws is necessary.

Stamped single contacts

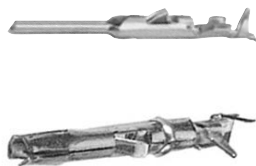

Stamped contacts on reel for hand crimping tools

200 pcs.



Stamped contacts on reel for crimping machines

2000 pcs.
feeds to the right



2000 pcs.
feeds to the left



Crimp Contacts, Pin, Standard

Contact Ø in mm	Isolation Ø in mm	No. of contacts	Wire gauge	Supplied as	Pieces	Part number Contact plating	
						Silver plated	Gold plated
1,6	1,0 - 2,0	6 + PE	0,14 - 0,5 mm ²	Single contact	100	VN 01 016 0011 (1)	VN 01 016 0011 (2)
				Contact on reel	200	ZN 01 016 0011 (1)	ZN 01 016 0011 (2)
				right	2000	HN 01 016 0011 (1)	HN 01 016 0011 (2)
				left	2000	TN 01 016 0011 (1)	TN 01 016 0011 (2)
1,6	1,8 - 2,8	6 + PE	0,5 - 1,5 mm ²	Single contact	100	VN 01 016 0004 (1)	VN 01 016 0004 (2)
				Contact on reel	200	ZN 01 016 0004 (1)	ZN 01 016 0004 (2)
				right	2000	HN 01 016 0004 (1)	HN 01 016 0004 (2)
				left	2000	TN 01 016 0004 (1)	TN 01 016 0004 (2)

Crimp Contacts, Socket, Standard

Contact Ø in mm	Isolation Ø in mm	No. of contacts	Wire gauge	Supplied as	Pieces	Part number Contact plating	
						Silver plated	Gold plated
1,6	1,0 - 2,0	6 + PE	0,14 - 0,5 mm ²	Single contact	100	VN 02 016 0003 (1)	VN 02 016 0003 (2)
				Contact on reel	200	ZN 02 016 0003 (1)	ZN 02 016 0003 (2)
				right	2000	HN 02 016 0003 (1)	HN 02 016 0003 (2)
				left	2000	TN 02 016 0003 (1)	TN 02 016 0003 (2)
1,6	1,8 - 2,8	6 + PE	0,5 - 1,5 mm ²	Single contact	100	VN 02 016 0002 (1)	VN 02 016 0002 (2)
				Contact on reel	200	ZN 02 016 0002 (1)	ZN 02 016 0002 (2)
				right	2000	HN 02 016 0002 (1)	HN 02 016 0002 (2)
				left	2000	TN 02 016 0002 (1)	TN 02 016 0002 (2)

High current crimp contacts upon request.

Tools

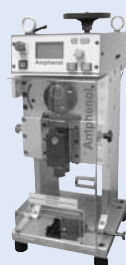

Find our tools in the catalogue "Tools".

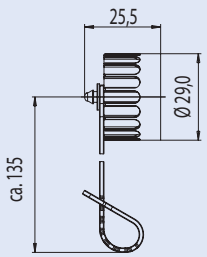
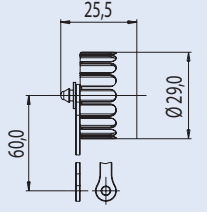
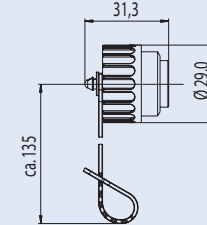
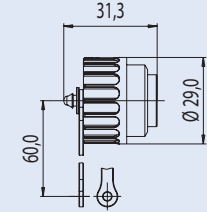
Description	Figure	Part number	Figure	Part number
Protective cover for male cable connector and male receptacle		for male cable connector C016 00U000 010 12		for male receptacle C016 00U000 000 12
Protective cover for female cable connector and female receptacle		for female cable connector C016 00V000 010 12		for female receptacle C016 00V000 000 12

Mounting of the protective covers on the back shell, male or female receptacles

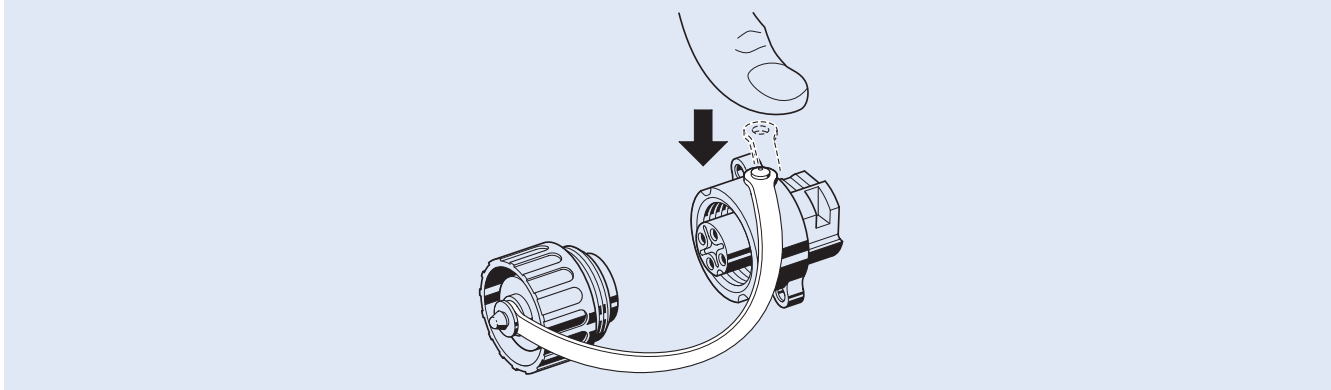

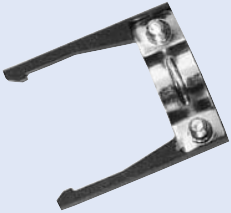
Description	Figure	Part number
Back shell, right angled with clamping ring Packaging unit 10 pcs.		Back shell color: blue: C016 G09 042 G10 X ¹⁾ black: C016 G09 041 G10 X ¹⁾
Cable clamp for all straight cable connectors, Packaging units 10 pcs.		Cable clamp diameter Ø 6 - 10 N 16 110 2000 X ¹⁾

¹⁾ X is synonymous for packaging unit 10 pcs.

Mounting Instruction, straight cable connector

Stripping Lengths	Measure a ¹⁾	Measure b
Screw contacts		
with internal cable retention	18 ⁺¹	7 ^{+1 2)}
without internal cable retention	25 ⁺¹	7 ^{+1 2)}
Solder contacts		
with internal cable retention	14 ⁺¹	4 ⁺¹
without internal cable retention	22 ⁺¹	4 ⁺¹
Crimp contacts		
0,14 – 0,50 mm ²		3 ^{+0,5}
0,50 – 1,5 mm ²		3,5 ⁺¹
with internal cable retention	14 ⁺¹	
without internal cable retention	22 ⁺¹	

1) PE + 2mm 2) end splice recommended

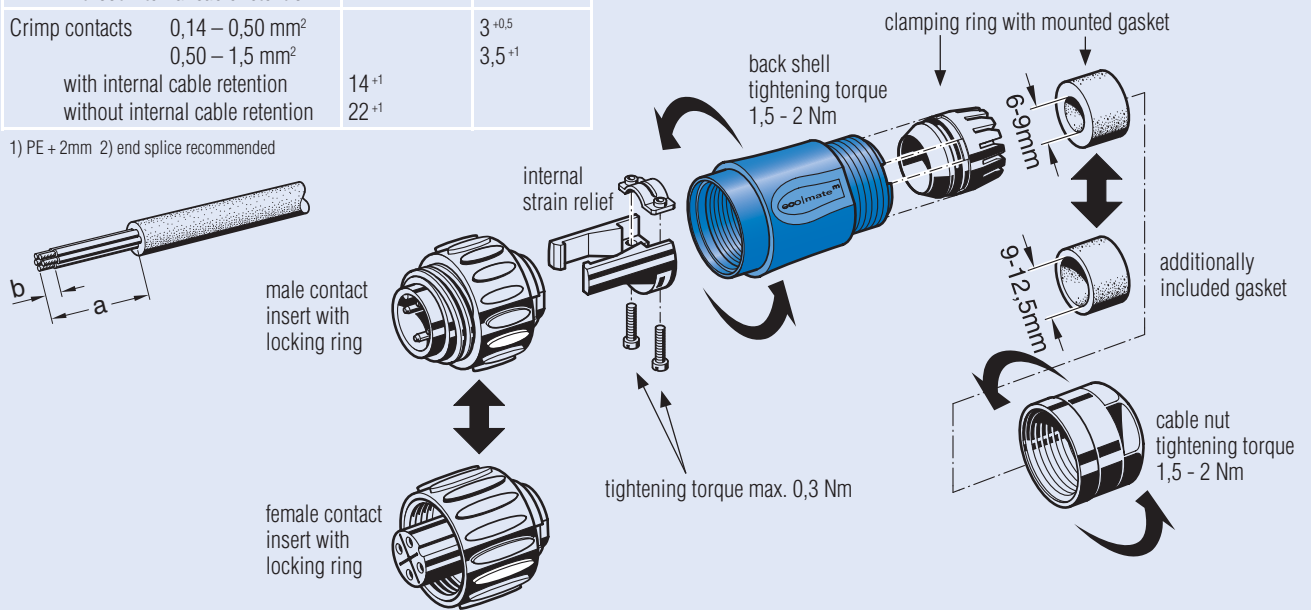

Mounting Instruction, right angled cable connector

Stripping Lengths	Measure a ¹⁾	Measure b
Screw contacts		
without internal cable retention	35 ⁺¹	7 ^{+1 2)}
Solder contacts		
without internal cable retention	32 ⁺¹	4 ⁺¹
Crimp contacts		
0,14 – 0,5 mm ²		3 ^{+0,5}
0,50 – 1,5 mm ²		3,5 ⁺¹
without internal cable retention	32 ⁺¹	

1) PE + 2mm 2) end splice recommended

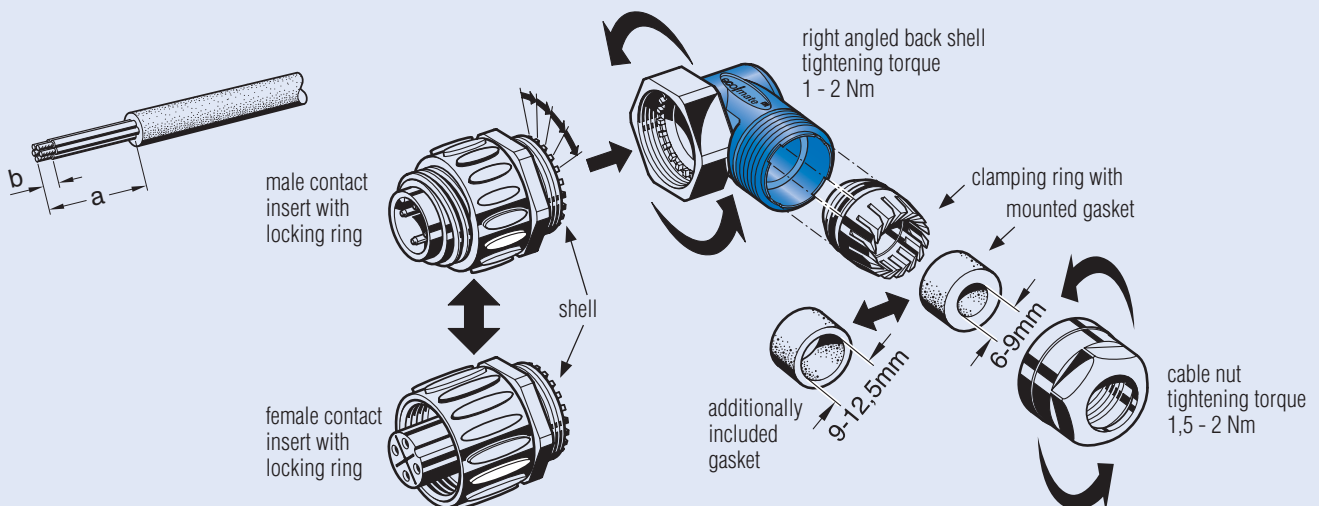

Screw Termination

Screw clamps are designed acc. to EN 60999-1/VDE 06095.1. Chart 1 below shows the screw size depending on wire size and the required clamping and testing torque.

Chart 1

Wire size (mm ²)	1,5	2,5
Screw size	M 3	M 3
Test torque (Ncm)	max. 50	max. 50

Diagram 1 below shows the range of tensile strength for a screw connection with a clamp screw M3, fastened with a torque of 50 Ncm, depending on the wire size.

Diagram 1

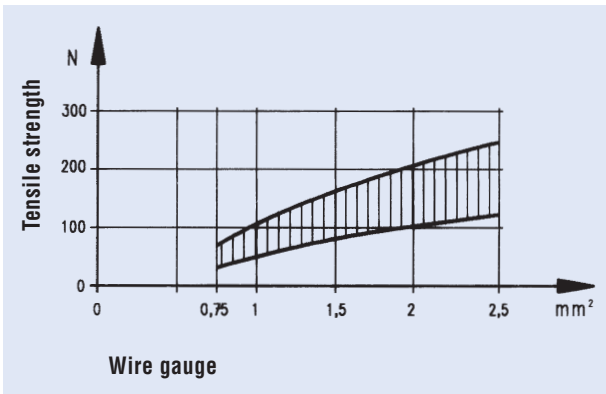

This comparison chart allows a cross reference between American Wire Gauge (AWG) and metric wire sizes (mm²).

Chart 2

AWG	Wire composition	Wire diameter	Wire size
30	1 x 0,25	0,25 mm	0,05 mm ²
	7 x 0,10	0,36 mm	0,06 mm ²
28	1 x 0,32	0,32 mm	0,08 mm ²
	7 x 0,13	0,38 mm	0,09 mm ²
26	1 x 0,40	0,40 mm	0,13 mm ²
	7 x 0,16	0,48 mm	0,14 mm ²
	19 x 0,10	0,51 mm	0,15 mm ²
24	1 x 0,51	0,51 mm	0,21 mm ²
	7 x 0,20	0,61 mm	0,23 mm ²
	19 x 0,13	0,64 mm	0,24 mm ²
22	1 x 0,64	0,64 mm	0,33 mm ²
	7 x 0,25	0,76 mm	0,36 mm ²
	19 x 0,16	0,81 mm	0,38 mm ²
20	1 x 0,81	0,81 mm	0,52 mm ²
	7 x 0,32	0,97 mm	0,56 mm ²
	19 x 0,20	1,02 mm	0,62 mm ²
18	1 x 1,02	1,02 mm	0,79 mm ²
	19 x 0,25	1,27 mm	0,96 mm ²
16	19 x 0,29	1,44 mm	1,23 mm ²
14	19 x 0,36	1,80 mm	1,95 mm ²
12	19 x 0,46	2,29 mm	3,09 mm ²
10	37 x 0,40	3,10 mm	4,60 mm ²
8	133 x 0,29	4,0 mm	8,80 mm ²
6	133 x 0,36	5,5 mm	13,5 mm ²

It is to be noted that wires of the same AWG number but with different composition have slightly different mm².

Crimp Termination

A crimp connection is a non-detachable electrical connection between a wire and a crimp contact produced with the crimp technology. Precise crimping dies which are matched to the crimp barrel and the wire size and a defined deformation result in a reliable electrical connection.

There are open crimp barrels (stamped contacts) and closed crimp barrels (turned contacts).

The main advantages of crimp connections are:

- Efficient termination of contacts
- Reproducible terminations achieve consistent electrical and mechanical results

The requirements for crimp connections are defined in IEC 60352 Part 2 / DIN EN 60352 Part 2.

An important point of the quality of a crimp connection is the achieved tensile strength of the termination.

Easily measured, the tensile strength is a practicable means for quality control purposes.

Diagram 2 below shows the required minimum tensile strength for open and closed barrels depending on the wire size.

Assembly instructions

For crimp contacts use the released crimp tool.

The insertion and extraction of crimp contacts shall only be approved with the corresponding insertion/extraction tool.

A detailed description of the crimp technology can be found in our crimp tooling catalogues.

Crimp contacts are in this catalogue on page 10.

Diagram 2

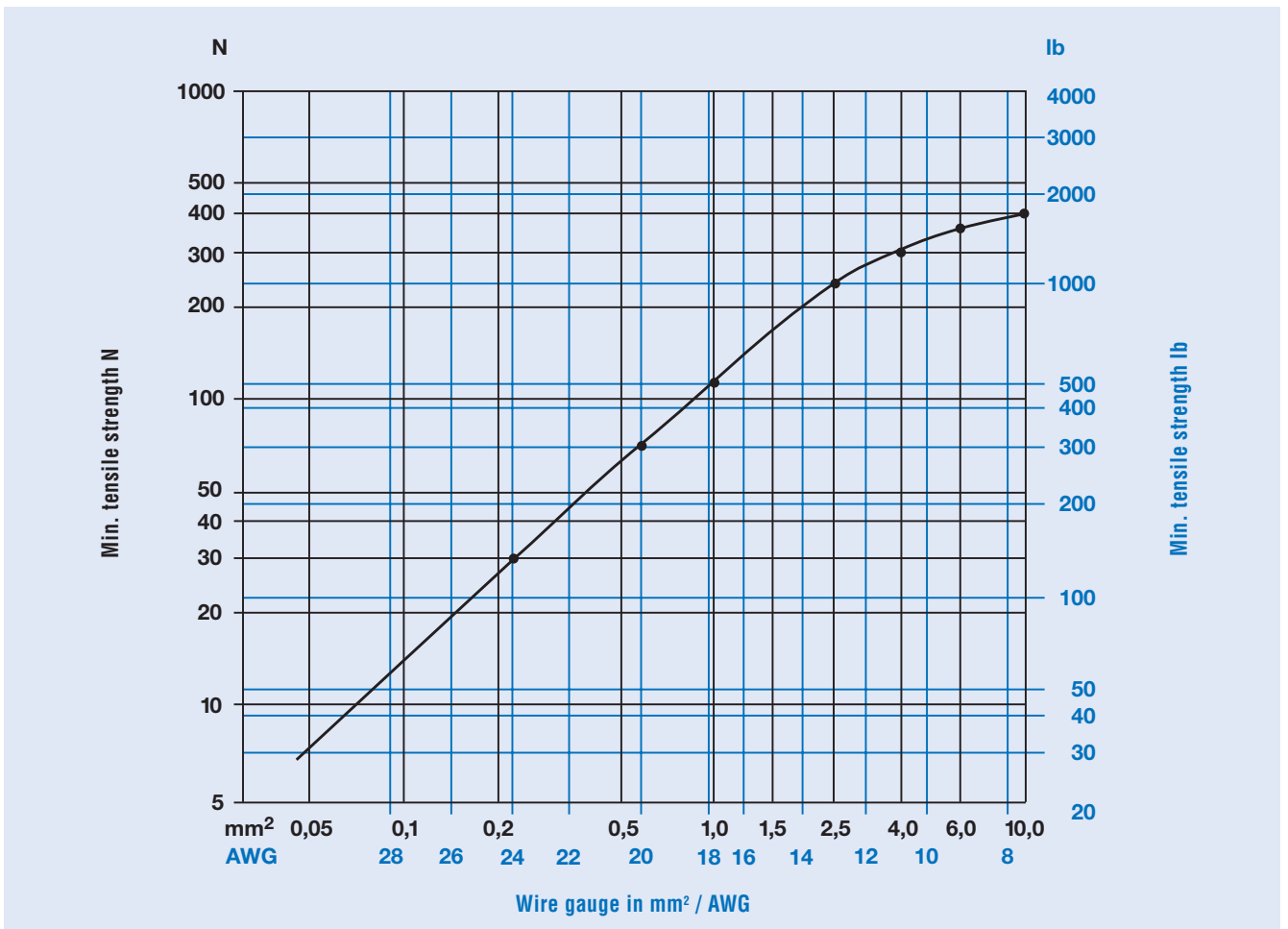

Degree of Protection

Electrical devices to which connectors belong to have to be protected for safety reasons from outside influences like dust, foreign objects, direct contact, moisture and water. This protection is provided on industrial connectors by its housings with their latching devices and sealed cable entries. The degree of protection can be selected depending on the type of intended use. The standard IEC 60529 and/or DIN EN 60529/VDE 0470 Part 1 has specified the degree of protection and divided into several classes.

The degree of protection is indicated in the following way:

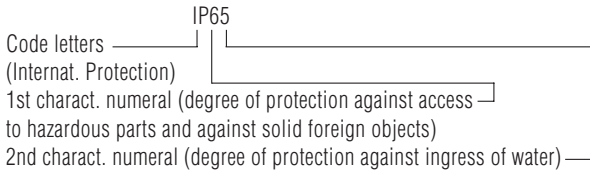

The following charts 4 an 5 give an overview about all protection degrees.

Chart 4

1st charact. numeral	Brief description	Definition
0	Non-protected	–
1	Protected against access to hazardous parts with the back of a hand. Protected against solid foreign objects of $\geq 50\text{mm } \varnothing$.	The probe, sphere of 50mm \varnothing , shall not fully penetrate and shall have adequate clearance from hazardous parts.
2	Protected against access to hazardous parts with a finger. Protected against solid foreign objects of $\geq 12,5\text{mm } \varnothing$.	The jointed test finger of 12mm \varnothing , 80mm length, shall have adequate clearance from hazardous parts. The probe, sphere of 12,5mm \varnothing , shall not fully penetrate.
3	Protected against access to hazardous parts with a tool. Protected against solid foreign objects of $\geq 2,5\text{mm } \varnothing$.	The probe of 2,5mm \varnothing shall not penetrate at all.
4	Protected against access to hazardous parts with a wire. Protected against solid foreign objects of $\geq 1\text{mm } \varnothing$.	The probe of 1mm \varnothing shall not penetrate at all.
5	Protected against access to hazardous parts with a wire. Dust-protected.	The probe of 1mm \varnothing shall not penetrate. Intrusion of dust is not totally prevented, but dust shall not penetrate in a quantity to interfere with satisfactory operation of the device or to impair safety.
6	Protected against access to hazardous parts with a wire. Dust-tight.	The probe of 1mm \varnothing shall not penetrate. No intrusion of dust.

Chart 5

2nd charact. numeral	Brief description	Definition
0	Non-protected	–
1	Protected against vertically falling water drops	Vertically falling drops shall have no harmful effects.
2	Protected against vertically falling water drops when enclosure tilted up to 15°	Vertically falling drops shall have no harmful effects when the enclosure is tilted at any angle up to 15° on either side of the vertical.
3	Protected against spraying water	Water sprayed at an angle up to 60° on either side of the vertical shall have no harmful effects.
4	Protected against splashing water	Water splashed against the enclosure from any direction shall have no harmful effects.
5	Protected against water jets	Water projected in jets against the enclosure from any direction shall have no harmful effects.
6	Protected against powerful water jets	Water projected in powerful jets against the enclosure from any direction shall have no harmful effects.
7	Protected against the effects of temporary immersion in water	Intrusion of water in quantities causing harmful effects shall not be possible when the enclosure is temporarily immersed in water for 30 min. in 1m depth.
8	Protected against the effects of continous immersion in water	Intrusion of water in quantities causing harmful effects shall not be possible when the enclosure is continuously immersed in water under conditions which shall be agreed between manufacturer and user but which are more severe than for numeral 7.
9K ¹⁾	Protected against water during high pressure/steam jet cleaning	Water projected in powerful jets with high pressure against the enclosure from any direction shall have no harmful effects.

¹⁾ Remark: Numeral acc. to DIN 40050 part 9, vehicles IP code.

1. General Remarks

These connectors are designed and produced in conformity with the low voltage directive (73/23/EWG) respectively Gerätesicherheitsgesetz (German law) and are especially in accordance with the standards DIN EN 61984 / IEC 61984 (VDE0627); IEC 60664-1 (VDE 0110-1) and IEC 60529.

The connectors may be used only within the technical ratings. All technical data refer to mated connectors under live conditions. The safety of the connector system depends on the correct selection of products, proper assembly of the connector device and a precise fit of the connectors.

2. Application Remarks

Connectors with / without breaking capacity must be used according to specified technical ratings.

The technical data represents the initial value of mated parts under predetermined conditions and length of time. These values could change with different test parameters or product requirements.

The connectors of the eco|mate^m series are designed for the areas of application including the construction and installation of controlling and electrical devices.

The product has been tested for the intended purposes only. If the connection is used other than originally intended, or in another manner that we have not previously tested, the consumer assumes full responsibility.

All rated data for the connectors listed in this catalogue are based on over-voltage category III ¹⁾ and pollution degree 3 ²⁾ for electronic applications. Connectors were completely mated according to their respective safety locking mechanism. Selection and testing of connectors with / without breaking capacity to meet specific product or industrial requirements such as rated voltage and the related clearances and creepage distances are the responsibility of the user.

3. Assembling Remarks

Protection against electrical shock of the termination of the connectors shall be secured by correct mounting. Connectors of the same or different series being mounted side by side may be protected against incorrect mating by the use of coding options. Care must be taken to ensure the parts are correctly mated and screws are tightened with the proper torque.

4. Termination Remarks

Cable connectors are effectively secured when using the strain relief (internal strain relief clamp or clamping ring). When the connector contains a simple gland bushing for retention without clamping ring the cable should have a strain relief close behind the connector. All cable properties or specifications must be compatible with the connector design and materials.

Designated wire conductors must be terminated to the correct poles in the connector.

Crimp contacts must be fully inserted into the plastic housing and strain relief assured with a slight tug on the wire.

Wire should be stripped correctly according to printed specifications to insure no electrical contact can be made between the conductors. There should be no nicked or cut strains during the stripping action.

5. Safety Classification acc. to DIN EN 61984 / VDE 0627 / IEC 61984

Style	enclosed mated	enclosed unmated	protective earthing contact	finger safety mated	finger safety unmated	hand back safety mated	connector with breaking capacity ¹⁾	rewirable	Cable clamp	
									with	without
Male cable connector	•	•	•	•	NA	•	•	•	•	•
Female cable connector	•		•	•	•	•	•	•	•	•
Male receptacle screw / crimp	•	•	•	•	NA	•	•	•		•
Female receptacle screw / crimp	•		•	•	• ³⁾	•	•	•		•
Male receptacle solder	•	•	•	• ³⁾	NA	• ³⁾	•	•		•
Female receptacle solder	•		•	• ³⁾	• ³⁾	• ³⁾	•	•		•

¹⁾ Overvoltage category III: Equipment intended for the use in installations or parts of it in which lightning overvoltages do not need to be considered, however switching overvoltages generated by the equipment, and for cases where the reliability and the availability of the equipment or its dependent circuits are subject to special requirements. Examples are protecting means, switches and sockets.

²⁾ Pollution degree 3: Conductive pollution occurs or dry non-conductive pollution occurs which becomes conductive due to condensation which is to be expected.

³⁾ Protection against electrical shock of the termination of the connectors shall be secured by correct mounting.

NA ≙ not applicable

Part No.	Page	Part No.	Page	Part No.	Page	Part No.	Page
C016 00U000 000 12	11	C016 20F003 100 10	9	C016 30F006 100 10	9	N 16 110 2000 X	11
C016 00U000 010 12	11	C016 20F003 100 12	9	C016 30F006 100 12	9	TN 01 016 0004 (1)	10
C016 00V000 000 12	11	C016 20F003 200 10	9	C016 30F006 200 10	9	TN 01 016 0004 (2)	10
C016 00V000 010 12	11	C016 20F003 200 12	9	C016 30F006 200 12	9	TN 01 016 0011 (1)	10
C016 10C006 000 12	9	C016 20G003 100 12	8	C016 30G006 100 12	8	TN 01 016 0011 (2)	10
C016 10D006 000 10	9	C016 20G003 200 12	8	C016 30G006 200 12	8	TN 02 016 0002 (1)	10
C016 10D006 000 12	9	C016 20H003 100 10	8	C016 30H006 100 10	8	TN 02 016 0002 (2)	10
C016 10D006 010 10	9	C016 20H003 100 12	8	C016 30H006 100 12	8	TN 02 016 0003 (1)	10
C016 10D006 010 12	9	C016 20H003 110 10	8	C016 30H006 110 10	8	TN 02 016 0003 (2)	10
C016 10F006 000 10	9	C016 20H003 110 12	8	C016 30H006 110 12	8	VN 01 016 0004 (1)	10
C016 10F006 000 12	9	C016 20H003 200 10	8	C016 30H006 200 10	8	VN 01 016 0004 (2)	10
C016 10G006 000 12	8	C016 20H003 200 12	8	C016 30H006 200 12	8	VN 01 016 0011 (1)	10
C016 10H006 000 10	8	C016 20H003 210 10	8	C016 30H006 210 10	8	VN 01 016 0011 (2)	10
C016 10H006 000 12	8	C016 20H003 210 12	8	C016 30H006 210 12	8	VN 02 016 0002 (1)	10
C016 10H006 010 10	8	C016 20K003 100 10	8	C016 30K006 100 10	8	VN 02 016 0002 (2)	10
C016 10H006 010 12	8	C016 20K003 100 12	8	C016 30K006 100 12	8	VN 02 016 0003 (1)	10
C016 10K006 000 10	8	C016 20K003 200 10	8	C016 30K006 200 10	8	VN 02 016 0003 (2)	10
C016 10K006 000 12	8	C016 20K003 200 12	8	C016 30K006 200 12	8	ZN 01 016 0004 (1)	10
C016 20C003 100 12	9	C016 30C006 100 12	9	C016 G09 041 G10 X	11	ZN 01 016 0004 (2)	10
C016 20C003 200 12	9	C016 30C006 200 12	9	C016 G09 042 G10 X	11	ZN 01 016 0011 (1)	10
C016 20D003 100 10	9	C016 30D006 100 10	9	HN 01 016 0004 (1)	10	ZN 01 016 0011 (2)	10
C016 20D003 100 12	9	C016 30D006 100 12	9	HN 01 016 0004 (2)	10	ZN 02 016 0002 (1)	10
C016 20D003 110 10	9	C016 30D006 110 10	9	HN 01 016 0011 (1)	10	ZN 02 016 0002 (2)	10
C016 20D003 110 12	9	C016 30D006 110 12	9	HN 01 016 0011 (2)	10	ZN 02 016 0003 (1)	10
C016 20D003 200 10	9	C016 30D006 200 10	9	HN 02 016 0002 (1)	10	ZN 02 016 0003 (2)	10
C016 20D003 200 12	9	C016 30D006 200 12	9	HN 02 016 0002 (2)	10		
C016 20D003 210 10	9	C016 30D006 210 10	9	HN 02 016 0003 (1)	10		
C016 20D003 210 12	9	C016 30D006 210 12	9	HN 02 016 0003 (2)	10		

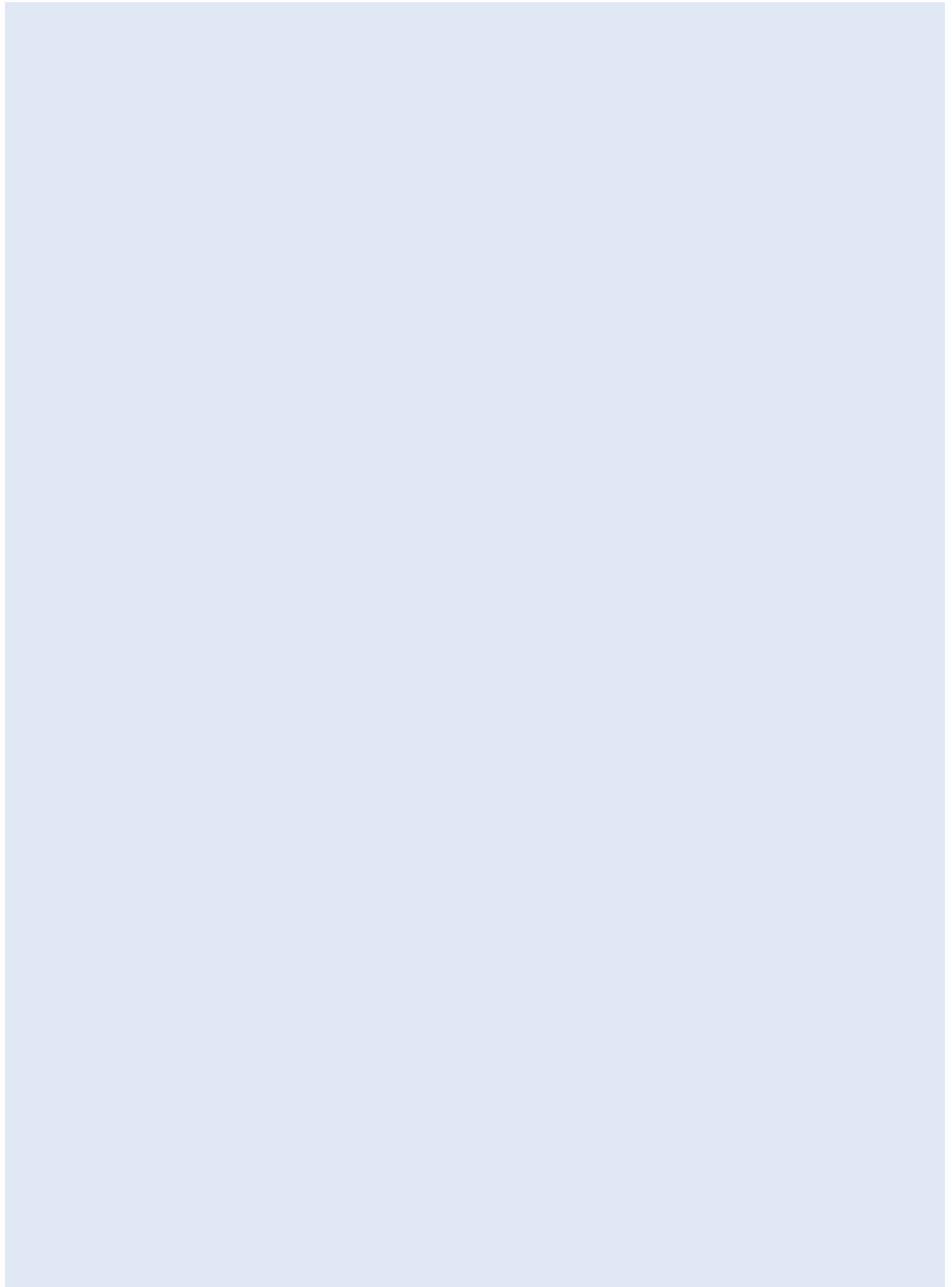

International

Argentina

Amphenol Argentina
Av. Callao 930
2nd Floor Office B "Plaza"
C 1023 AAP Buenos Aires
Phone +54 / 11 / 4815 68 86
Fax +54 / 11 / 48 1457 79

Australia

Amphenol Australia Ltd.
2 Fiveways Blvd
Keysborough
Victoria 31 73
Phone +61 / 3 / 8796 / 8888
Fax +61 / 3 / 8796 / 8801

Belgium

Amphenol-Tuchel Belgium
Brusselbaan 524b
B 1600 Sint-Pieters-Leeuw
Phone +32 / 2377 / 2549
Fax +32 / 2377 / 5303

Brasilia

Amphenol do Brasil Ltda.
Rua Diogo Moreira 132, 20th Floor
CEP 05423-010 Sao Paulo SP
Phone +55 / 11 / 3815.1003
Fax +55 / 11 / 3815.1629

China

Amphenol-Tuchel Electronics GmbH
China Branch
210-1 Taishan Road
Changzhou 213022
Phone +86 / 0519 / 5110301
Fax +86 / 0519 / 5110299

France

Amphenol-Tuchel France
Bât. Le Newton C
7 Mail B. Thimonnier
77185 Lognes
Phone +33 / 164627676
Fax +33 / 164627677

Germany

Amphenol-Tuchel Electronics GmbH
August-Haeusser-Str. 10
74080 Heilbronn
Phone +49 / 7131 / 929-0
Fax +49 / 7131 / 929-486

Great Britain

Amphenol-Tuchel Great Britain
14 Plover Close
Kempshott, Basingstoke
Hants, RG22 5PQ
Phone +44 / 1256 / 330749
Fax +44 / 1256 / 330749

Hong Kong

Amphenol East Asia Limited
Units 2201-02, Railway Plaza
39 Chatham Road South
Tsimshatsui, Kowloon
Phone +852 / 2699 / 2663
Fax +852 / 2688 / 0974

India

Amphetronix Limited
Plot No. 105 Bhosari Industrial Area
Pune - 411 026
Phone +91 / 20 / 27121418
Fax +91 / 20 / 27120581

Italy

Amphenol-Tuchel Italy
Via Barbaiana n. 5
I-20020 Lainate (MI)
Phone +39 / 2 / 932 541
Fax +39 / 2 / 932 54444

Japan

Amphenol Japan, K.K.
2-3-27, Kudan Minami
Chiyoda-Ku
Tokyo 102
Phone +81 / 3 / 3263 / 5611
Fax +81 / 3 / 5276 / 7059

Korea

Amphenol DaeShin Limited
#802 Joong-Dong 1131-5
Wonmi-Ku
Bucheon-City
Kyunggi-Do
Korea 420-020
Phone +82 / 2 / 785 / 1588
Fax +82 / 2 / 589 / 1514

Mexico

Amphenol Mexico
Prolongacion Reforma 61 - 6 B2
Col. Paseo de las Lomas
C.P. 01330 Mexico D.F.
Phone +52 / 55 / 5258.9984
Fax +52 / 55 / 5081.6890

Singapore

Amphenol East Asia Limited
Asia Pacific Sales Operation
Singapore Branch
300 Beach Road
#25-07 The Concourse
Singapore 199555
Phone +27 / 11 / 305-9574
Fax +27 / 11 / 305-9576

South Africa

Amphenol International Ltd
Chislehurst
30 Impala Road
Chislehurst
Sandton, 2146
Phone +27 / 11 / 7839517
Fax +27 / 11 / 7839519

Spain

Amphenol-Tuchel Spain
Ctra Sabadell a Mollet,
km 4.5 Nave 5
08130 Santa Perpetua de
Mogoda (Barcelona)
Phone +34 / 93 / 574.41.34
Fax +34 / 93 / 574.10.09

Sweden

Amphenol-Tuchel Scandinavia
P.O. Box 20
SE 195 42 Märsta
Phone +46 / 8 591 / 175 76
Fax +46 / 8 591 / 175 76

Taiwan

Amphenol East Asia Ltd.
Taiwan Branch (H.K.)
116 Zhong Shan Road
Lane 956 Taoyuan City
Taiwan R.O.C. 330
Phone +886 / 3 / 370 / 7855
Fax +886 / 3 / 360 / 7259

Turkey

Amphenol Turkiye
Ayazaga Mah. Meydan Sk. No. 28
Beybi Giz Plaza, Kat. 26
34396 Maslak/Istanbul
Phone +90 / 0212 / 3352501
Fax +90 / 0212 / 3352500

USA

Amphenol-Tuchel Electronics
6900 Haggerty Road
Suite 200
Canton, Michigan 48187
Phone +1 / 734 / 4516400
Fax +1 / 734 / 451 7197

Amphenol Corporation
Corporate Headquarters
358 Hall Avenue
Wallingford, CT 06492
Phone +1 / 800 / 380 8052
Phone +1 / 203 / 265 / 89 00
Fax +1 / 203 / 265 / 86 28

Your engineering sales representative:

Amphenol

Amphenol-Tuchel Electronics GmbH

August-Haeusser-Str. 10 · D-74080 Heilbronn · Germany · Phone +49 (0) 7131/929-0 · Fax +49 (0) 7131/929-486 · www.amphenol.info