

heavy|mate - C146 M socket module

Part No. C146 S10 001 G8

Series Heavy duty connectors heavy|mate - C 146

Subseries Heavy duty connector heavy|mate - C146 M



COMMON CHARACTERISTICS		
Colour		black
Flammability		V-0
ELECTRICAL CHARACTERISTICS		
Installation category	DIN EN 60664-1 / IEC 60664-1	III
Insulation group	DIN EN 60664-1 / IEC 60664-1	II
Insulation resistance	DIN EN 60512-3-1, Test 3a / IEC 60512-3-1, Test 3a	$\geq 10^{12}$
Contact resistance	DIN EN 60512-2-1, Test 2a / IEC 60512-2-1, Test 2a	< 5 m
Pollution degree	DIN EN 60664-1 / IEC 60664-1	3

heavy|mate - C146 M socket module

Part No. C146 S10 001 G8

Series Heavy duty connectors heavy|mate - C 146

Subseries Heavy duty connector heavy|mate - C146 M

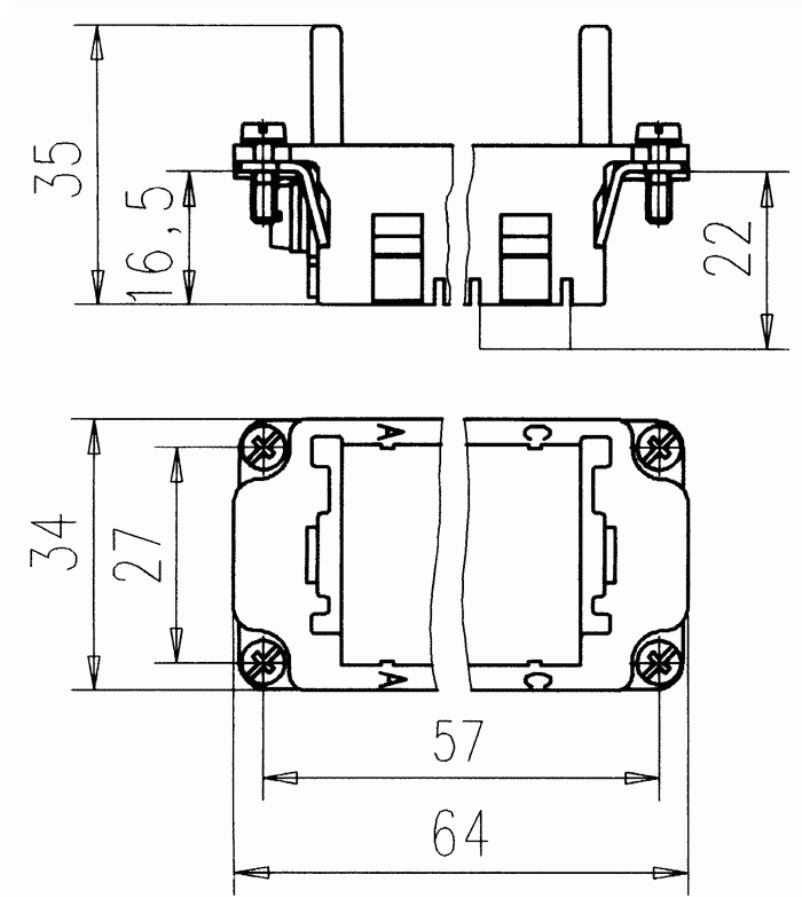

Ma zeichnung Dimensions in mm (Inch)

20.09.2007