

CONFIGURATION	PART NUMBER	LENGTH
M23 A SERIES - CORD GRIP CABLE RANGE: 4.5mm - 7.5mm	MA3CG-S1	TBD

DIMENSIONS

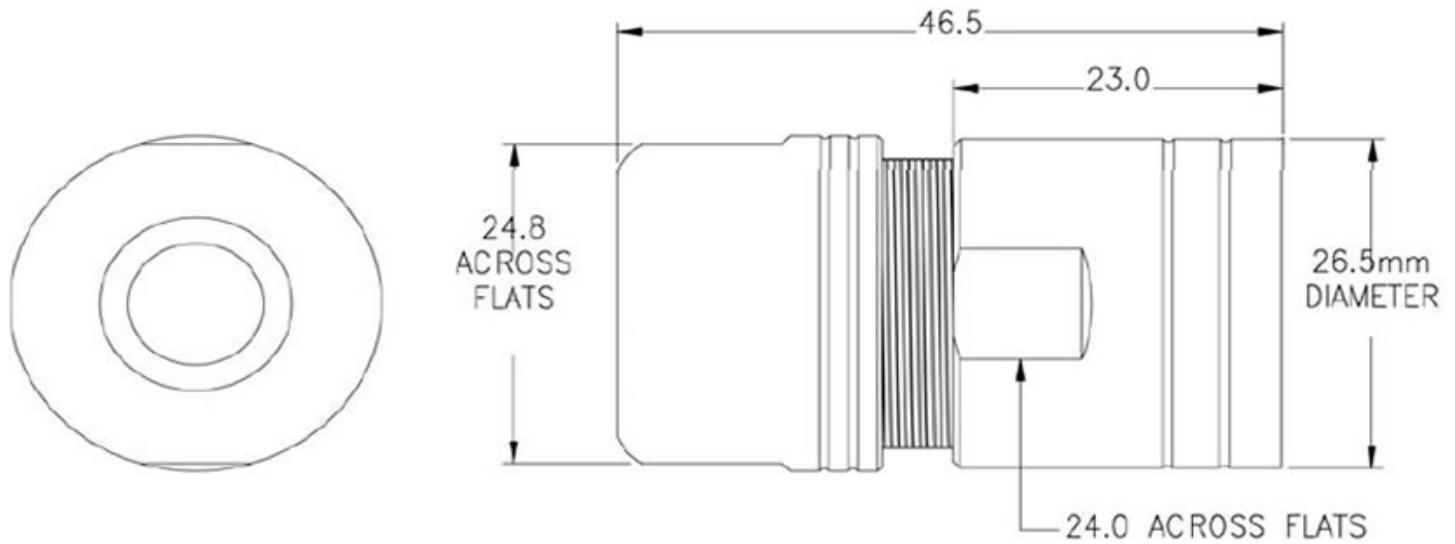

CABLE RANGE: 4.5mm - 7.5mm

TECHNICAL DATA

TEMPERATURE RANGE:	-20C to +130C
PROTECTION:	IP 67 (PLUGGED CONDITION)
DEGREE OF PROTECTION:	3
OVER VOLTAGE CATEGORY:	III
HOUSING BODY:	ZINC DIE-CAST

NOTES