

# Powerpole® Modular Connectors

B

## The Anderson Powerpole® Modular Concept

Invented by Anderson Power Products®, the innovative modular Powerpole® connectors provide cost-effective reliability, design flexibility and mistake-proof capability for your products' manufacture, installation and maintenance.

The identical, interchangeable, genderless interconnects ensure short assembly cycle times, a simple-bill-of-materials, minimized work-in-process and low inventory parts count. Insert crimped contact into housings and plug together for a clever, simple and low-cost solution to power interconnection. Low-detent contacts are also offered for low insertion/withdrawal force applications.

Powerpole® modular connectors are available in 10 to 180 amp maximum ratings for use through 600 Volts continuous, AC or DC operation. There are Powerpoles® for every application and wire size, #20 to 1/0 AWG. Contacts are available in reeled and loose piece designs to support all production needs from very high volumes to engineering prototype and low volume customized products. Powerpoles® are stackable and color-coded for easy customization into multi-pole blocks with or without mechanical keys and make first-break last contacts.

Powerpole® connectors are UL recognized and CSA Certified, VDE pending. Standard 94V2 rating and available for 94VO applications. For wire-to-board, wire-to-wire or board-to-board, Powerpole® modular connectors have been proven in decades of electronic and electrical system reliability and cost-effectiveness for OEM's worldwide.

All dimensions are for reference only and are not intended for specification purposes. Specific details will be furnished upon request.

Current Rating	A		B		C		D	
	in.	mm	in.	mm	in.	mm	in.	mm.
10 amp	0.32	7.9	0.32	7.9	0.97	24.6	1.63	41.3
15 amp	0.32	7.9	0.32	7.9	0.97	24.6	1.63	41.3
30 amp	0.32	7.9	0.32	7.9	0.97	24.6	1.63	41.3
45 amp	0.32	7.9	0.32	7.9	0.97	24.6	1.63	41.3
75 amp	0.63	15.9	0.63	15.9	1.88	47.6	3.20	81.4
120 amp	0.88	22.2	0.88	22.2	2.75	69.9	4.63	117.5
180 amp	1.13	28.6	1.13	28.6	3.25	82.6	5.50	139.7

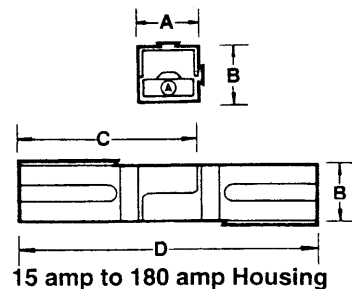
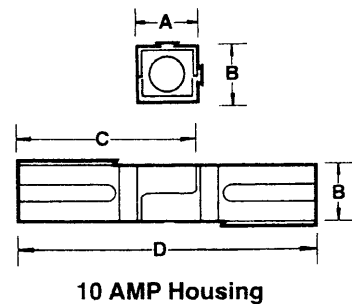

 UL Recognized

 CSA Certified

 Pending

**Anderson Power Products®**

Anderson Power Products: 13 Pratts Junction Rd. P.O. Box 579, Sterling, MA 01564 • (508) 422-8101 Fax: 508-422-8948 or 8005

# Powerpole® Modular Connectors

**B**

A range of wire sizes from smallest to the largest conductor normally recommended for the Powerpole® Series of connectors is shown in Table A. The wire sizes are listed in AWG and MCM for each of the models. Reducing bushings which must be used to accommodate smaller wire sizes are also listed in the Table.

The maximum continuous current rating for a wire conductor is limited by the conductor size, the number of conductors contained in a cable, and maximum temperature rating of the cable. Procedures that describe the correct methods to determine conductor size, current capacity (in terms of applied loads versus temperature rise) and methods for crimping and soldering are described in following sections.

**TABLE A WIRING GUIDE**

POWERPOLE MODEL	STRANDED COPPER CONDUCTOR (SIZE AWG OR MCM)														
	20	18	16	14	12	10	8	6	4	2	1	1/0	2/0	3/0	4/0
PP10			■■■■		(**)										
PP15	■■■■		■■■■												
PP30			■■■■		■■■■										
PP45				■■■■		■■■■									
PP60				■■■■		■■■■		■■■■							
PP75		■■■■	■■■■	■■■■		■■■■		■■■■							
PP120							■■■■	■■■■		■■■■					
PP180						■■■■	■■■■	■■■■	■■■■		■■■■		■■■■		

■■■■■ REDUCING BUSHING USED TO ACCOMMODATE SMALLER WIRE SIZES  
 (\*\*) CONTACT RATING IS LESS THAN MAX. CURRENT CARRYING CAPABILITY OF 14 & 16 AWG WIRE

# Powerpole® Modular Connectors

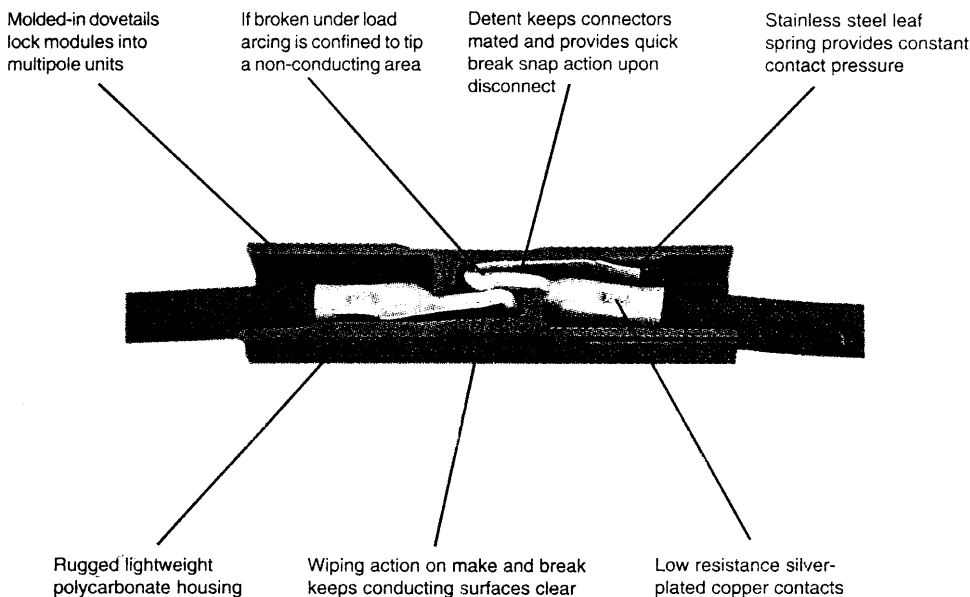

## Where Do Contacts Contact?

Although electrical contacts appear to have a large surface area, only a small portion of that area actually touches the mating part, because any metal surface - no matter how finely polished or ground - is never perfectly flat or smooth.

The butt contact conducts current via three or less summits or high peaks (asperities).

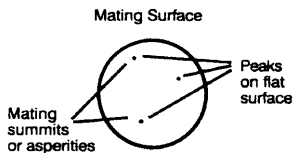

The cylindrical contact, although it appears to have a large, ample area, actually conducts current through no more than three lines of contact in this example.

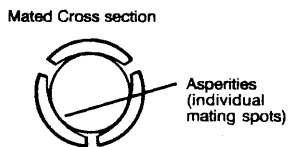

The sliding contact, when spring loaded, conducts current through an entire line of contact.

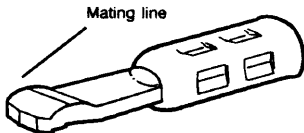

## What Makes a Good Connector?

The termination can make the difference between good and poor connector continuity. This hypothetical example of a "good" and "poor" connector shows how power loss can seriously impair the efficiency of an EV. Important are two points of resistance: 1.  $R_c$ , the central contact resistance. 2.  $R_w$ , the resistance at two terminations. A typical sliding connector carries 175 A. But when the termination resistivity,  $R_w$ , rises because of faulty design or assembly, total resistance rises, too (See Table). Using the basic relationship for DC power,

$$P = (I \times R) \quad (I) = I^2R$$

The "good" conductor dissipates, or loses,  
 $P = (175)^2 (0.00004) = 1.225 \text{ W}$

while the "poor" conductor loses,  
 $P = (175)^2 (0.00202) = 61.8 \text{ W}$

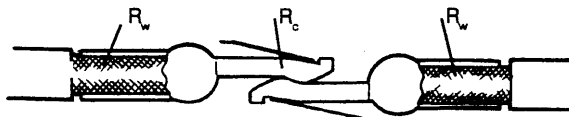

### Good vs. Poor Connection

Typical Joint	$R_w$	$R_c$	$R_w$	$R_{total}$
Good	0.000010	0.000020	0.000010	0.000040
Poor	0.001000	0.000020	0.001000	0.002020

# Powerpole® Modular Connectors

B

## 10 amp Series Connectors

Catalog Number	Description	Housing Color	
1200G1	Housing with a contact	Green - male	socket connector
1201G1		Green - female	socket connector
1204G1	Housing	Green - male	socket housing
1205G1		Green - female	socket housing

## 10 amp Contacts

Catalog Number	Description	Wire AWG	Diameter		Cable Size
			in.	mm	sq. mm
1202G1	Socket contact	14/16	.08/.06	2.0/1.5	2.1/1.3
1203G1	Pin contact	14/16	.08/.06	2.0/1.5	2.1/1.3
264G1	Reel socket contact	14/16	.08/.06	2.0/1.5	2.1/1.3
263G1	Reel Pin contact	14/16	.08/.06	2.0/1.5	2.1/1.3

## 15 amp Series Connectors

Catalog Number	Description	Housing Color	Wire AWG	Diameter		Cable Size
				in.	mm	sq. mm
1395	Housing with a spring and a	Red	16/20	.06/.04	1.5/1.0	1.3/.52
1395G1		Black	16/20	.06/.04	1.5/1.0	1.3/.52
1395G2	15 amp contact	White	16/20	.06/.04	1.5/1.0	1.3/.52
1395G3		Green	16/20	.06/.04	1.5/1.0	1.3/.52
1395G4		Blue	16/20	.06/.04	1.5/1.0	1.3/.52
1395G5		Yellow	16/20	.06/.04	1.5/1.0	1.3/.52
1395G6		Orange	16/20	.06/.04	1.5/1.0	1.3/.52
1395G7		Gray	16/20	.06/.04	1.5/1.0	1.3/.52

\* Housings available in the 15/45 amp section.

## 15 amp Contacts

Catalog Number	Description	Wire AWG	Diameter		Cable Size
			in.	mm	sq. mm
1332	Individual contact	16/20	.06/.04	1.5/1.0	1.3/.52
26261	Reel contact	16/20	.06/.04	1.5/1.0	1.5/1.0

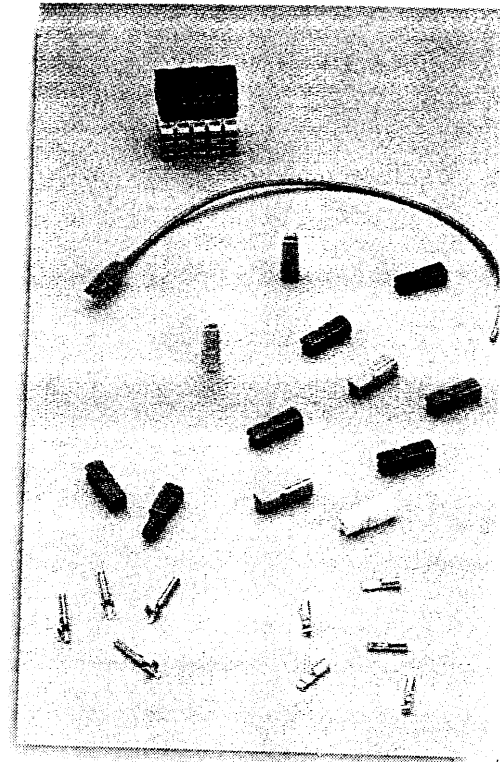

# Powerpole® Modular Connectors

## 25 amp Printed Circuit Board Contacts

Catalog Number	Description
1377G1	Right angle bend .700 long from bend
1377G2	Right angle bend .400 long from bend
1377G3	Straight terminal 2.16 inches long
1377G4	Straight terminal 1.7 inches long

Patent Number: 5,458,510

## 25 amp Printed Circuit Board Reel Contacts

Catalog Number	Description
266G1	Reel Contact

## 30 amp Series Connectors

Catalog Number	Description	Housing Color	Wire AWG	Diameter		Cable Size
				in.	mm	sq. mm
1330	Housing with a spring and a contact	Red	12/16	.10/.06	2.6/1.5	3.3/1.3
1330G2		Green	12/16	.10/.06	2.6/1.5	3.3/1.3
1330G4		Black	12/16	.10/.06	2.6/1.5	3.3/1.3
1330G5		White	12/16	.10/.06	2.6/1.5	3.3/1.3
1330G11		Yellow	12/16	.10/.06	2.6/1.5	3.3/1.3
1330G12		Blue	12/16	.10/.06	2.6/1.5	3.3/1.3
1330G13		Orange	12/16	.10/.06	2.6/1.5	3.3/1.3
1330G14		Gray	12/16	.10/.06	2.6/1.5	3.3/1.3
1330G15		Brown	12/16	.10/.06	2.6/1.5	3.3/1.3
1330G16		Pink	12/16	.10/.06	2.6/1.5	3.3/1.3
1330G17		Purple	12/16	.10/.06	2.6/1.5	3.3/1.3

Housings available in the 15/45 amp section

## 30 amp Contacts

Catalog Number	Description	Wire AWG	Diameter		Cable Size
			in.	mm	sq. mm
1331	Individual	12/16	.10/.06	2.6/1.5	3.3/1.3
261G1	Reel Contact	12/16	.10/.06	2.6/1.5	3.3/1.3

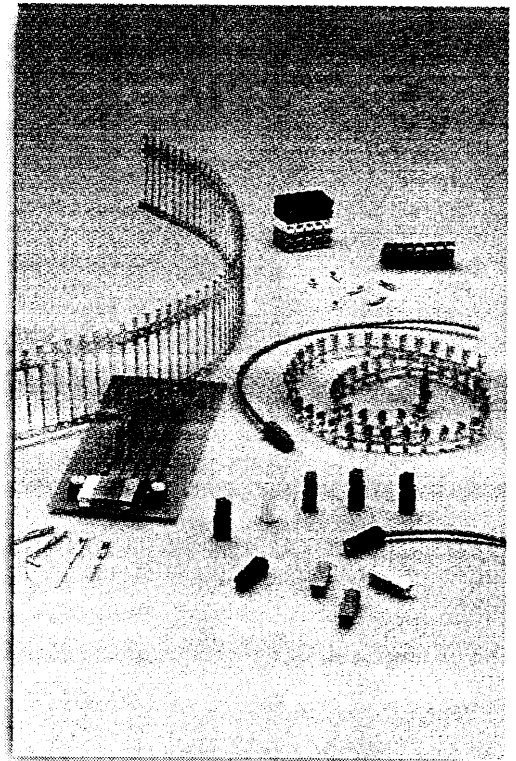

# Powerpole® Modular Connectors

**B**

## 15/45 amp Housings

Catalog Number	Description	Housing Color
1327	Housing with a spring	Red
1327G5		Green
1327G6		Black
1327G7		White
1327G8		Blue
1327G16		Yellow
1327G17		Orange
1327G18		Gray
1327G21		Brown
1327G22		Pink
1327G23		Purple

\* Can be used with 15, 25, 30 & 45 amp contacts

## 15/45 amp Housings - 94V0

Catalog Number	Description	Housing Color
PP15/45RED	Housing with a spring	Red
PP15/45GRN		Green
PP15/45BLK		Black
PP15/45WHT		White
PP15/45BLU		Blue
PP15/45YEL		Yellow
PP15/45ORN		Orange
PP15/45GRA		Gray
PP15/45BRN		Brown
PP15/45PNK		Pink
PP15/45PRP		Purple

\* Can be used with 15, 25, 30 & 45 amp contacts

## 45 amp Contacts

Catalog Number	Description	Wire AWG	Diameter in.	Diameter mm	Cable Size sq. mm
261G2	Reel contact	10/14	.13/.08	3.2/2.1	5.3/2.1
261G2-LPBK	(Loose piece)	10/14	.13/.08	3.2/2.1	5.3/2.1

## 15/45 amp Accessories

### Powerpole® Boot

Catalog Number	Description	Color
1441G1 - Female	Splash Resistant Boots	Black
1442G1 - Male	Splash Resistant Boots	Black

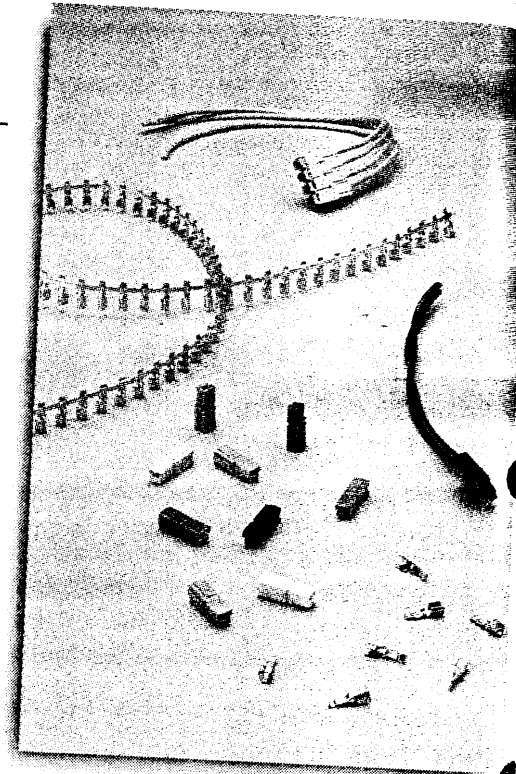

# Powerpole® Modular Connectors

## Blok Lok

Maintain positive connection for a block of mated Powerpole® pairs.

Catalog Number	For Use With	Description	Color
110G21	10/45 amp	2 Pole application	Black
110G12	housing	4 Pole application	Black

## Mounting Accessories

Catalog Number	For Use With	Description	Color
1399G9	15/45 amp	Genderless mounting wing	Red
1399G8	Powerpole	Genderless mounting wing	Blue
1399G3	connector	Mounting adapter/spacer with a side hole	Red
1462G1		2 & 4 pole mounting clamp (set)	Metal
1462G2		3 & 6 pole mounting clamp (set)	Metal
1462G3		4 & 8 pole mounting clamp (set)	Metal

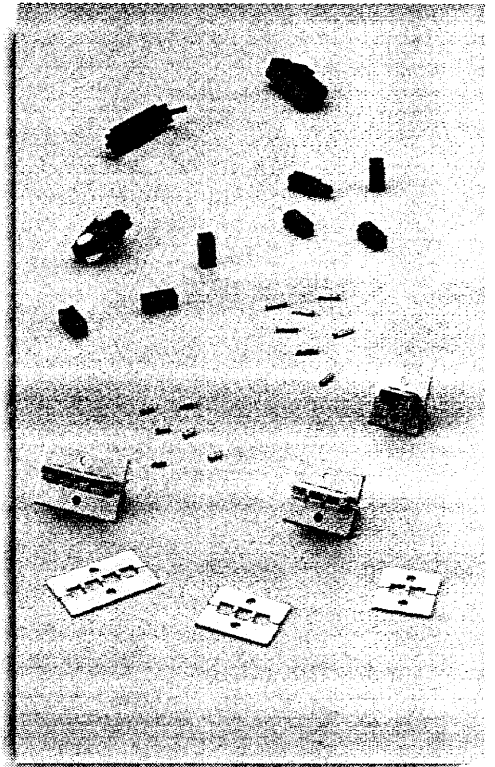

## Retaining Pins

Lock rows or blocks of unmounted Powerpoles® together using these pins.

Catalog Number	For Use With	Description	Color
110G16	15/45 amp	1 high block of connectors	Metal
110G17	Powerpole connector	2 high block of connectors	Metal

## Spacers

Catalog Number	For Use With	Description	Color
1399G1	15/45 amp	Short spacer with an end hole	Red
1399G2	Powerpole	Long spacer	Red
1399G3	connector	Mounting adapter/spacer with a side hole	Red
1399G6		Short spacer without a hole	Red

# Powerpole® Modular Connectors

**B**

## 60 amp Reel Contacts - Tin plated

Catalog Number	Description	Wire AWG	Diameter		Cable Size sq. mm	
			in.	mm		
265G5	Reel contact	6/8	.22/	16	5.5/4.1	13.3/8.4
265G6	*Low Detent	10/12	.13/	10	3.2/2.8	5.3/3.3
265G7	*Low Detent	6/8	.22/	16	5.5/4.1	13.3/8.4
265G8		10/12	.13/	10	3.2/2.8	5.3/3.3

Patent Pending

Using 10/12 AWG wire reduces rating to 40 amps  
\* To provide lower insertion force

## 70 amp Reel Contacts - Silver Plated

Catalog Number	Description	Wire AWG	Diameter		Cable Size sq. mm	
			in.	mm		
265G1	Reel contact	6/8	.22/	16	5.5/4.1	13.3/8.4
265G2	Reel contact	10/12	.13/	10	3.2/2.8	5.3/3.3
265G3	Low Detent	6/8	.22/	16	5.5/4.1	13.3/8.4
265G4	Low Detent	10/12	.13/	10	3.2/2.8	5.3/3.3

Patent Pending

Using 10/12 AWG wire reduces rating to 50 amps  
\* To provide lower insertion force

## 75 amp Series Connectors

Catalog Number	Description	Housing Color	Wire AWG	Diameter		Cable Size sq. mm
				in.	mm	
1300	Housing with	Blue	#6	.22	5.5	13.3
1300G2	a spring and a	Green	#6	.22	5.5	13.3
1300G3	contact	Red	#6	.22	5.5	13.3
1300G4		Black	#6	.22	5.5	13.3
1300G5		White	#6	.22	5.5	13.3

## 75 amp Housings

Catalog Number	Description	Housing Color
5916	Housing with	Blue
5916G4	a spring	Black
5916G5		White
5916G6		Green
5916G7		Red

\* Can be used with 60, 70 & 75 amp contacts

## 75 amp Housings - 94V0

Catalog Number	Description	Housing Color
PP75BLU	Housing with	Blue
PP75BLK	a spring	Black
PP75WHT		White
PP75GRN		Green
PP75RED		Red

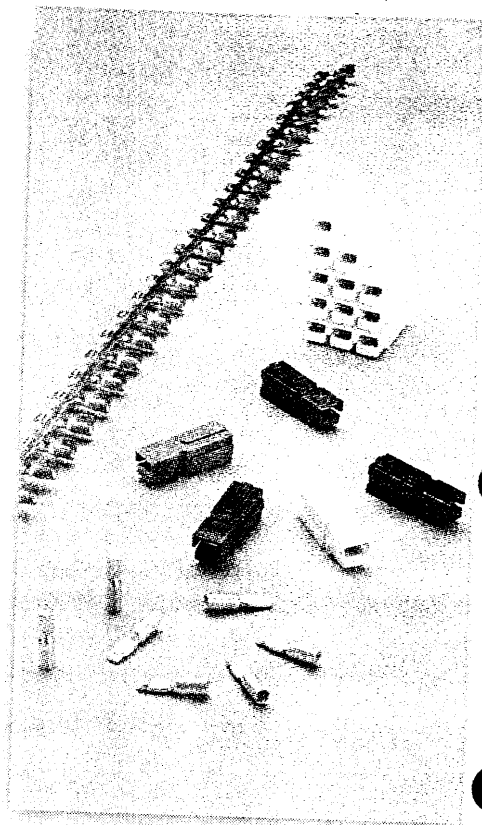



# Powerpole® Modular Connectors

## 75 amp Contacts

Catalog Number	Description	Wire AWG	Diameter		Cable Size
			in.	mm	sq. mm
5900	Individual	# 6	.22	5.5	13.3
1307	Individual-Low Detent	# 6	.22	5.5	13.3
5952	Individual	# 8	.16	4.1	8.4
5915	Individual	10/12	.13/.10	3.2/2.8	5.3/3.3

using 10/12 AWG wire reduces rating to 50 amps

## Bushings

Assures proper fit for smaller cable sizes when crimping contacts

Catalog Number	Use With Contact No.	Accommodates AWG	Cable Size sq. mm
5910	5900 or 1307	10/12	5.3/3.3
5912		6/8	13.3/8.37
5913		6/14 & #16	13.3/2.1 1.3

## Mounting Accessories

Catalog Number	For Use With	Description	Color
1399G7	75 amp Powerpole® connector	Genderless mounting wing	Blue
1463G1		2 & 4 pole mounting clamp (set)	Metal
1463G2		3 & 6 pole mounting clamp (set)	Metal

see dimensions on page 24

## Retaining Pins

Lock rows or blocks of unmounted Powerpoles® together using these pins

Catalog Number	For Use With	Description	Color
110G18	75 amp 120 amp 180 amp Powerpole® connectors	2 high block of connectors	Metal
110G19	75 amp 120 amp 180 amp Powerpole® connectors	1 high block of connectors	Metal



B

# Powerpole® Modular Connectors

**B**

## 120 amp Series Connectors

Catalog Number	Description	Housing Color	Wire AWG	Diameter		Cable Size
				in.	mm	sq. mm
1320	Housing with	Blue	# 2	.34	8.6	33.6
1320G1	spring and a	Black	# 2	.34	8.6	33.6
1320G2	contact	White	# 2	.34	8.6	33.6
1320G3		Red	# 2	.34	8.6	33.6
1320G4		Green	# 2	.34	8.6	33.6

## 120 amp Housings

Catalog Number	Description	Housing Color
1321	Housing with	Blue
1321G1	a spring	Black
1320G2		White
1320G3		Red
1321G4		Green

## 120 amp Housings - 94V0

Catalog Number	Description	Housing Color
PP120BLU	Housing with	Blue
PP120BLK	a spring	Black
PP120WHT		White
PP120RED		Red
PP120GRN		Green

## 120 amp Contacts

Catalog Number	Description	Wire AWG	Diameter		Cable Size
			in.	mm	sq. mm
1319	Individual	#2	.34	8.6	33.6
1319G4		#4	.27	6.8	21.2
1319G6		#6	.22	5.5	13.3

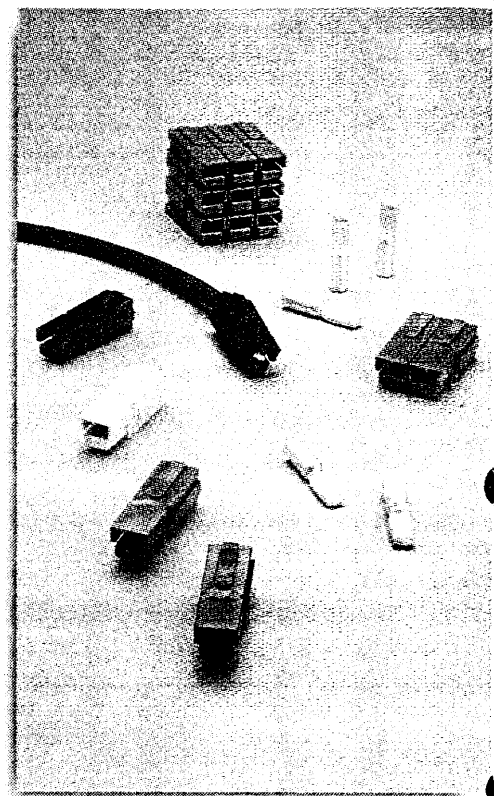

# Powerpole® Modular Connectors

## 180 amp Series Connectors

Catalog Number	Description	Housing Color	Wire AWG	Cable Well Diameter		Cable Size sq. mm
				in.	mm	
1380	Housing with a spring and a contact	Blue	1/0	.42	10.7	53.5
1380G1		Black	1/0	.42	10.7	53.5
1380G2		White	1/0	.42	10.7	53.5
1380G3		Red	1/0	.42	10.7	53.5
1380G4		Green	1/0	.42	10.7	53.5

## 180 amp Housings

Catalog Number	Description	Housing Color
1381	Housing with a spring	Blue
1381G1		Black
1381G2		White
1381G3		Red
1381G4		Green

## 180 amp Housings - 94V0

Catalog Number	Description	Housing Color
PP180BLU	Housing with a spring	Blue
PP180BLK		Black
PP180WHT		White
PP180RED		Red
PP180GRN		Green

## 180 amp Contacts

Catalog Number	Description	Wire AWG	Cable Well Diameter		Cable Size sq. mm
			in.	mm	
1382	Individual	1/0	.42	10.7	53.5
1383		#2	.34	8.6	33.6
1384		#4	.27	6.8	21.2

## Bushings

Assures proper fit for smaller cable sizes when crimping contacts

Catalog Number	Use With Contact No.	Accommodates AWG	Wire Size sq. mm
5648	1382	1/0 to #10	53.5/5.1
5663		1/0 to #6	53.5/13.3
5687		1/0 to #1	53.5/42.4
5690		1/0 to #2	53.5/33.6
5693		1/0 to #4	53.5/21.2

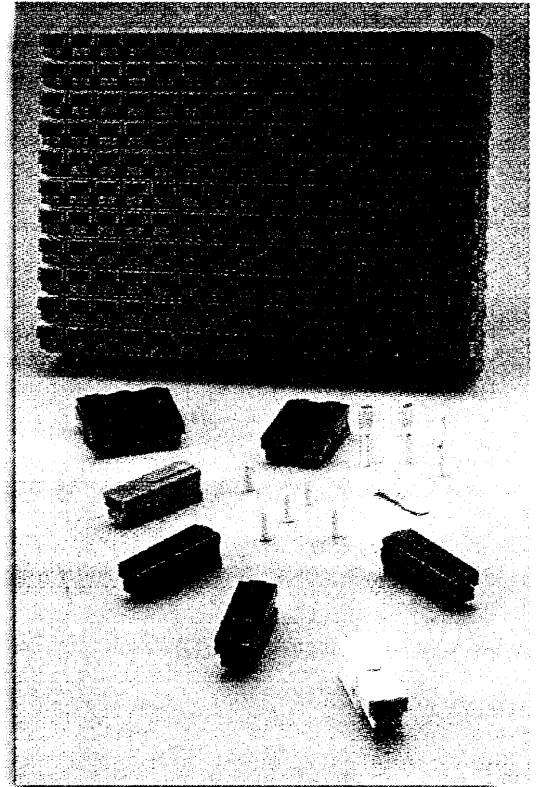

# Powerpole® Modular Connectors

## Bushings

Assures proper fit for smaller cable sizes when crimping contacts.

Catalog Number	Use With Contact No.	Accommodates AWG	Cable Size sq. mm
5919	1319	#4	33.6/21.2
5920		#6	33.6/13.3
5921		#8	33.6/8.34

## Mounting Accessories

Catalog Number	For Use With	Description	Color
1464G1	120 amp	2 & 4 pole mounting clamp (set)	Metal
1464G2	Powerpole® connector	3 pole mounting clamp (set)	Metal

see dimensions on page 23

## Retaining Pins

Lock rows or blocks of unmounted Powerpoles® together using these pins.

Catalog Number	For Use With	Description	Color
110G18	75 amp 120 amp 180 amp Powerpole® connectors	2 high block of connectors	Metal
110G19	75 amp 120 amp 180 amp Powerpole® connector	1 high block of connectors	Metal
110G20	120 amp 180 amp Powerpole® connector	2 high block of connectors	Metal

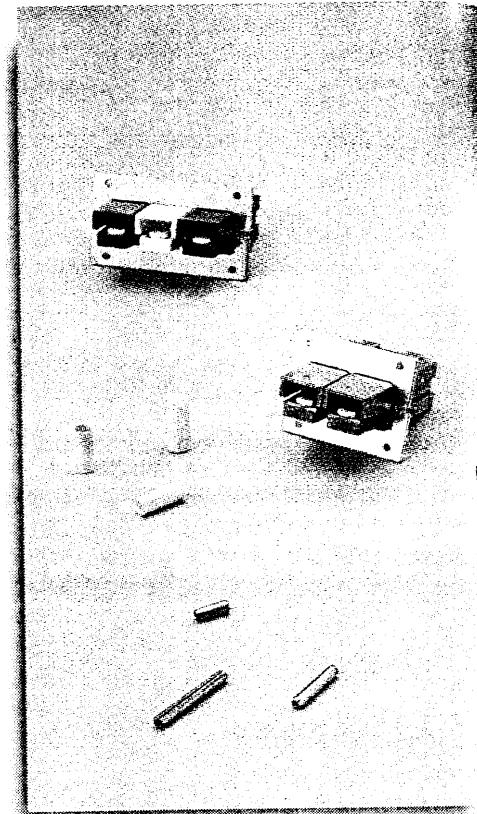

# Powerpole® Modular Connectors

## Mounting Accessories

Catalog Number	For Use With	Description	Color
1465G1	180 amp	2 pole mounting clamp (set)	Metal
1465G2	Powerpole® connectors	3 pole mounting clamp (set)	Metal

see dimensions on page 23

## Retaining Pins

Lock rows or blocks of unmounted Powerpoles® together using these pins.

Catalog Number	For Use With	Description	Color
110G18	75 amp 120 amp 180 amp Powerpole® connectors	2 high block of connectors	Metal
110G19	75 amp 120 amp 180 amp Powerpole® connectors	1 high block of connectors	Metal
110G20	120 amp 180 amp Powerpole® connectors	2 high block of connectors	Metal

Insertion/Extraction Tools see page 55 & 67

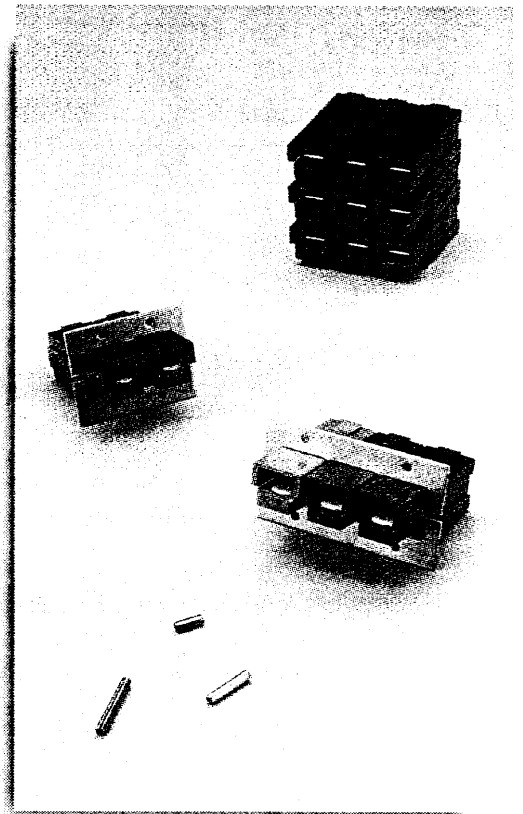

# Powerpole® Modular Connectors

## Powerpole Pak Housings

**B**

Powerpole Paks are high impact and corrosion-resistant black thermoplastic outer shells for containing our blocked 10 to 45 amp Powerpole® connectors. They allow easy connection and disconnection of electrical equipment in commercial and industrial applications. Cable clamps provide strain relief and integral latches prevent accidental disconnection of your equipment. The three housings - Plug with Latch, Plug without Latch and Snap-In Receptacle accommodate 2 to 8 circuits for orderly cable management systems and "clean-looking" appearances.

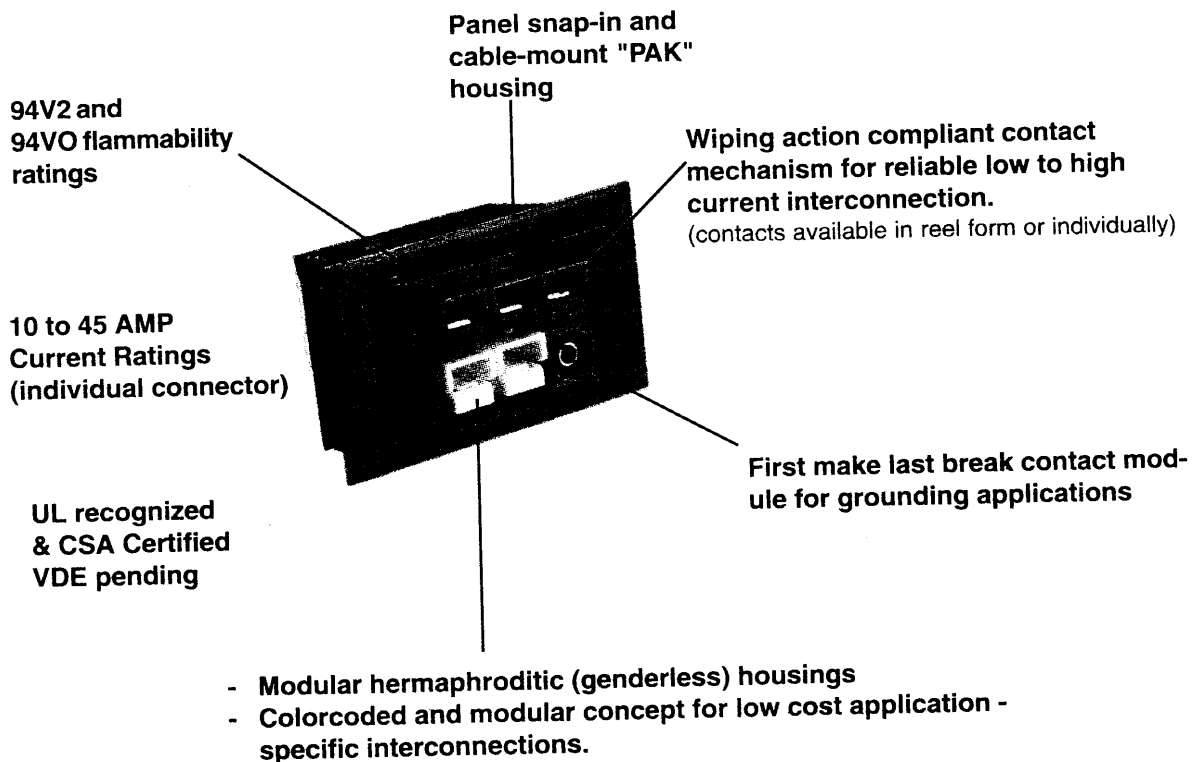

# Powerpole® Modular Connectors

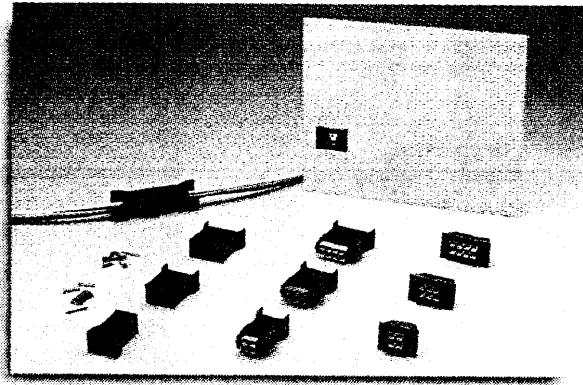

Catalog No.	Dimensions	A	B	C	D
1460G1	inches	2.25	1.24	0.85	1.94
2, 3, 4, Pole	mm	57.15	31.50	21.59	49.28
1460G2	inches	2.25	1.56	0.85	1.94
5, 6 Pole	mm	57.15	39.62	21.59	49.28
1460G3	inches	2.25	1.87	0.85	1.94
7, 8 Pole	mm	57.15	47.50	21.59	49.28

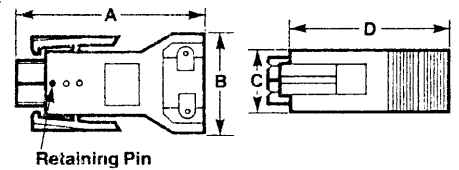

Plug with latch

Catalog No.	Dimensions	E	F	G	H
1461G1	inches	2.09	1.24	0.85	1.94
2, 3, 4 Pole	mm	53.09	31.50	21.59	49.28
1461G2	inches	2.09	1.56	0.85	1.94
5, 6 Pole	mm	53.09	39.62	21.59	49.28
1461G3	inches	2.09	1.87	0.85	1.94
7, 8 Pole	mm	53.09	47.50	21.59	49.28

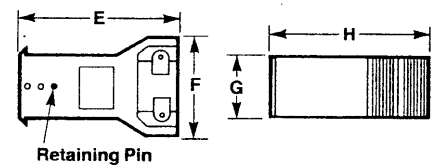

Plug without latch

Catalog No.	Dimensions	J	K	L	M	Knockout Size
1470G1	inches	1.50	0.07	0.77	1.10	1.00 x 1.25
2, 3, 4 Pole	mm	38.10	1.78	19.56	27.94	25.40 x 31.75
1470G2	inches	1.88	0.07	0.77	1.10	1.00 x 1.62
5, 6 Pole	mm	47.75	1.78	19.56	27.94	25.40 x 41.15
1470G3	inches	2.13	0.07	0.77	1.10	1.00 x 1.88
7, 8 Pole	mm	54.10	1.78	19.56	27.94	25.40 x 47.76

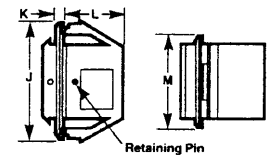

Snap-in Receptacle

Designed for panels 0.030-0.134" thick. \* Knockout punches are available. Greenlee P/N 71279 - 1.25 x 1.00

## Typical Powerpole® Pak Contact Configuration

(S-short  
Spacer Key)

(L-Long  
Spacer Key)

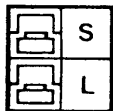

2 Pole  
Male & Female

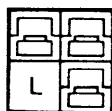

3 Pole Male

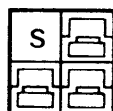

3 Pole  
Female

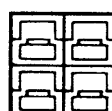

4 Pole

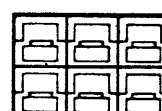

6 Pole  
Male & Female

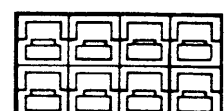

8 Pole

Anderson Power Products®

# Powerpole® Modular Connectors

**B**

## Plug with Latch

6 Pole Plug Exploded View with Conduit Clamp

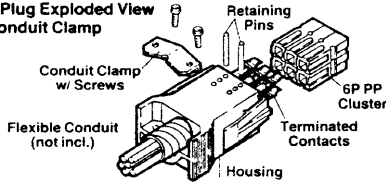

### Description

Complete Powerpole® Pak Plug with Latch - includes Powerpole® Pak Plug Housing, 30 amp black Powerpole connectors and Cable Clamp Hardware Pak.

### Size

2 Pole	1450G3
3 Pole	1451G3 (male)
4 Pole	1452G3
6 Pole	1453G3
8 Pole	1454G3

### Catalog No.

\* Note: The recommended tightening torque for conduit/cable clamp screws is 5 in.lb max. - over tightening may cause stripping to occur.

## Plug without Latch

3 Pole Plug Exploded View with Cable Clamp

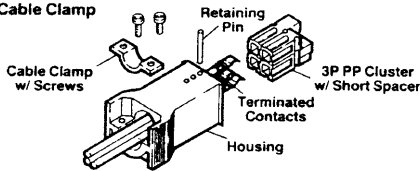

### Description

Complete Powerpole® Pak Plug without Latch - includes Powerpole® Pak Plug Housing, 30 amp black Powerpole® connectors and Cable Clamp Hardware Pak.

### Size

2 Pole	1450G2
3 Pole	1451G2 (female)
3 Pole	1451G6 (male)
4 Pole	1452G2
6 Pole	1453G2
8 Pole	1454G2

### Catalog No.

\* Note: The recommended tightening torque for conduit/cable clamp screws is 5 in.lb max. - over tightening may cause stripping to occur.

## Snap-in Receptacle

8 Pole Receptacle Exploded View

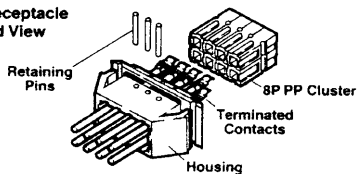

### Description

Complete Powerpole® Pak Receptacle - includes Powerpole® Pak Receptacle Housing, 30 amp black Powerpole® connectors and Retaining Pin(s)

### Size

2 Pole	1450G1
3 Pole	1451G1 (female)
4 Pole	1452G1
6 Pole	1453G1
8 Pole	1454G1

### Catalog No.

## Powerpole® Pak Hardware

### Description

### Size

### Catalog No.

*Color coding, special keying, wiring with flexible conduit or using 10 or 45 amp Powerpole® connectors are possible by specifying above Powerpole® Pak outer housing, Powerpole® connectors and spacer keys from pg. 24 and Powerpole® Pak Hardware from table on page 21.*

Cable Clamp Hardware Pak for Plug with Latch or Plug without Latch- includes cable clamp, 2 screws & retaining pin(s) for strain relief.

4 Pole	115G1
6 Pole	115G2
8 Pole	115G3

Flexible Conduit Hardware Pak for Plug with Latch and Plug without Latch - includes conduit clamp, 2 screws & retaining pin(s) for capturing flexible conduit at back end of plug.

4 Pole	110G10
6 Pole	110G11
8 Pole	10G15

Retaining Pin(s) for Snap-In Receptacle

1 Req'd	4 Pole	110G9
2 Req'd	6 Pole	110G9
3 Req'd	8 Pole	110G9

**FOR TEMPERATURE RISE AND PULSE CURRENT CHARACTERISTICS, USE THE PP10, PP15, PP30 AND PP45 MULTIPOLE GRAPHS IN THIS SECTION.**



# Powerpole® Modular Connectors

## 94VO 15/45 amp Powerpole® Pak Outer Housings

Catalog. No.	Description
PLG/LAT/2-4P	PP Pak 2-4 pole housing with a latch
PLG/LAT/5-6P	PP Pak 5-6 pole housing with a latch
PLG/LAT/7-8P	PP Pak 7-8 pole housing with a latch
PLG/2-4P	PP Pak 2-4 pole housing without a latch
PLG/5-6P	PP Pak 5-6 pole housing without a latch
PLG/7-8P	PP Pak 7-8 pole housing without a latch
REC/2-4P	PP Pak 2-4 pole snap-in receptacle
REC/5-6P	PP Pak 5-6 pole snap-in receptacle
REC/7-8P	PP Pak 7-8 pole snap-in receptacle

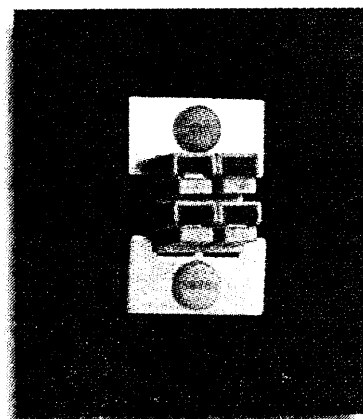

## Accessories

**Mounting Clamps** - Mount blocks of Powerpoles® quickly and easily through a bulkhead or cabinet with these clamps. Mate smaller ratings with Powerpole® Pak Plugs without Latches (pg. 4), larger ratings with Powerpoles blocked using Retaining Pins.

Model No.	Poles	Dimensions	A	B	C	D	Dia.
1462G1	2P	inches	0.94	1.06	0.68	--	0.156
		mm	23.88	26.92	17.27	--	3.962
15/45A	4P	inches	0.94	1.38	1.00	--	0.156
		mm	23.88	35.05	25.40	--	3.962
1462G2	3P	inches	1.25	1.06	0.68	--	0.156
		mm	31.75	26.92	17.27	--	3.962
15/45A	6P	inches	1.25	1.38	1.00	--	0.156
		mm	31.75	35.05	25.40	--	3.962
1462G3	4P	inches	1.56	1.06	0.68	--	0.156
		mm	39.62	26.92	17.27	--	3.962
15/45A	8P	inches	1.56	1.38	1.00	--	0.156
		mm	39.62	25.40	35.05	--	3.962
1463G1 75A	2P	inches	1.62	1.36	1.06	1.25	0.156
		mm	41.15	34.54	26.92	31.75	3.962
75A	4P	inches	1.62	1.98	1.68	1.25	0.156
		mm	41.15	50.29	42.67	31.75	3.962
1463G2 75A	3P	inches	2.25	1.36	1.06	1.88	0.156
		mm	57.15	34.54	26.92	47.75	3.962
75A	6P	inches	2.25	1.98	1.68	1.88	0.156
		mm	57.15	50.29	42.67	47.75	3.962
1464G1 120A	2P	inches	2.38	1.88	1.50	1.75	0.156
		mm	60.45	47.75	38.10	44.45	3.962
120A	4P	inches	2.38	2.76	2.38	1.75	0.156
		mm	60.45	70.10	60.45	44.45	3.962
1464G2 120A	3P	inches	3.25	1.88	1.50	2.62	0.156
		mm	82.55	47.75	38.10	66.55	3.962
1465G1 180A	2P	inches	2.81	2.18	1.68	1.12	0.190
		mm	71.37	55.37	42.67	28.45	4.826
1465G2 180A	3P	inches	3.97	2.18	1.68	2.25	0.190
		mm	100.84	55.37	42.67	57.15	4.826

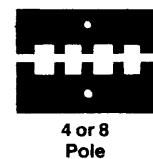
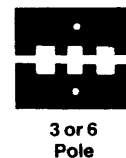
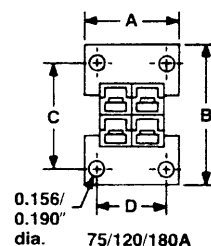
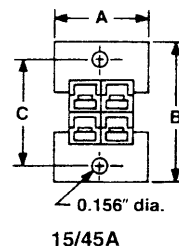

**Anderson Power Products®**

Anderson Power Products: 13 Pratts Junction Rd. P.O. Box 579, Sterling, MA 01564 • (508) 422-8101 Fax: 508-422-8948 or 8005

# Powerpole® Modular Connectors

## WINGS

**B**

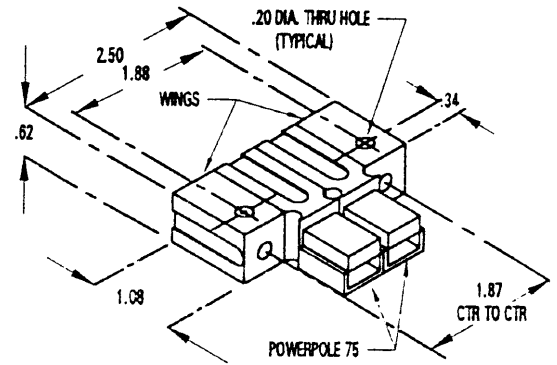
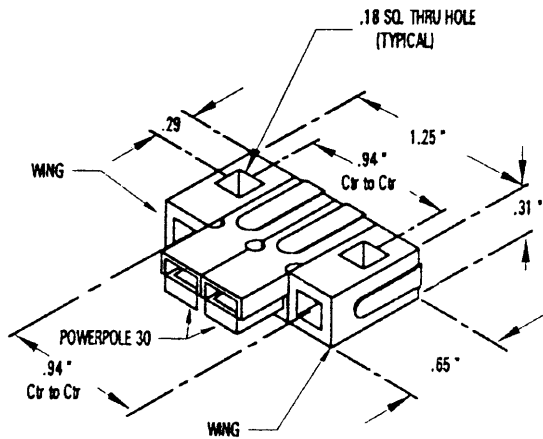

Powerpole® 10 to 45 amp Mounting Wing  
 P/N 1399G8 - Blue  
 1399G9 - Red

Powerpole® 75 amp Mounting Wing  
 P/N 1399G7 - Blue

## SPACERS

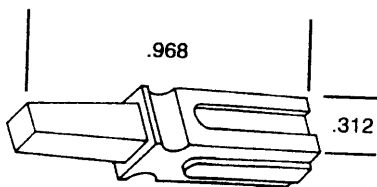

1399G2

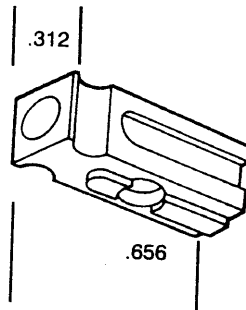

1399G3

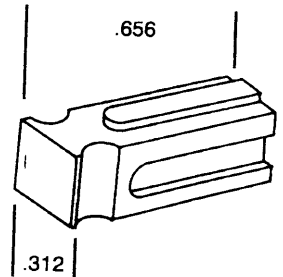

1399G6

# Powerpole® Modular Connectors

## Operating Characteristics

### Ampere/Temperature Curves (See Figures 1 through 24)

Ampere/Temperature curves help to evaluate and rate

Powerpole® connectors in terms of applied current load versus temperature rise.

Each graph shows the curves resulting from loading the smallest and largest cables (AWG size) normally recommended for a particular connector; curves for cables between the smallest and largest can be easily estimated. Thus, with consideration of both ampere and temperature characteristics, connectors can be selected according to load and temperature limits or requirements of particular installations.

### Typical Single Pole Characteristics

Connector Model	PP10	PP15	PP30	PP45	PP60	PP75	PP120	PP180
UL Current Rating (Ampere)*	10	15	30	45**	70**	75**	120	180
UL Voltage Rating (Volts) ***	600	600	600	600	600	600	600	600
Contact Barrel Wire Size Accommodation (AWG) *	#14 to #16	#16 to #20	#12 to #16	#10 to #14	#6 to #12	#6 to #16	#2 to #8	1/0 to #10
AVG Contact Resistance * (Ohms)	.002200	.000875	.000600	.000525	.000220	.000200	.000136	.000100
Insulation Withstanding Test Voltage (Volts DC)	2200	2200	2200	2200	2200	2200	2200	2200
Maximum Wire Insulation Diameter (inches)	0.137	0.175	0.175	0.175	0.437	0.437	0.600	0.900
Contact Retention Force (lbs)	25	25	25	35	50	50	100	170
Avg. Connection/Disconnect Force (lbs)	5	3	3	3	7	7	8	20
Operating Temperature Range °C ****	-20° to 105°	-20° to 105°	-20° to 105°	-20° to 105°	-20° to 105°	-20° to 105°	-20° to 105°	-20° to 105°
Flammability Rating of Housing Material	UL 94V2 & UL 94V0							

\* For 65°C rated wire or cable size

\*\* For 75°C rated wire or cable size

\*\*\* Both AC & DC Voltage

\*\*\*\* Contact factory for higher temperature rated connectors

# Powerpole® Modular Connectors

B

## Conversion Chart of American Wire Gauge to Metric System

Size AWG or MCM	Amperes		Circular Mils	Area Square Inches	Square mm	Approx. Diameter	
	Single Cond. 75°C Copper (NFA)					Inches ClassM (NEMA)	mm
20	7	1020	.0008	.52	.038	.97	
18	10	1620	.0013	.82	.048	1.22	
16	15	2580	.0020	1.31	.060	1.52	
14	20	4110	.0032	2.08	.078	1.98	
12	25	6530	.0051	3.31	.101	2.57	
10	40	10380	.0082	5.26	.126	3.20	
8	65	16510	.0130	8.37	.162	4.11	
6	95	26240	.0206	13.30	.215	5.46	
4	125	41740	.0328	21.15	.269	6.83	
2	170	66360	.0521	33.62	.337	8.56	
1	195	83690	.0657	42.41	.376	9.55	
1/0	230	105600	.0829	53.50	.423	10.74	
2/0	265	133100	.1045	67.43	.508	12.90	
3/0	310	167800	.1318	85.01	.576	14.63	
4/0	360	211600	.1662	107.20	.645	16.38	
250 MCM	405	250000	.1964	126.70	.713	18.11	
300 MCM	445	300000	.2356	152.00	.768	19.51	
500 MCM	620	500000	.3927	253.40	.997	25.32	
750 MCM	785	750000	.5891	380.00	1.207	30.66	
1000 MCM	935	1000000	.7854	506.70	1.404	35.66	

# Powerpole® Modular Connectors

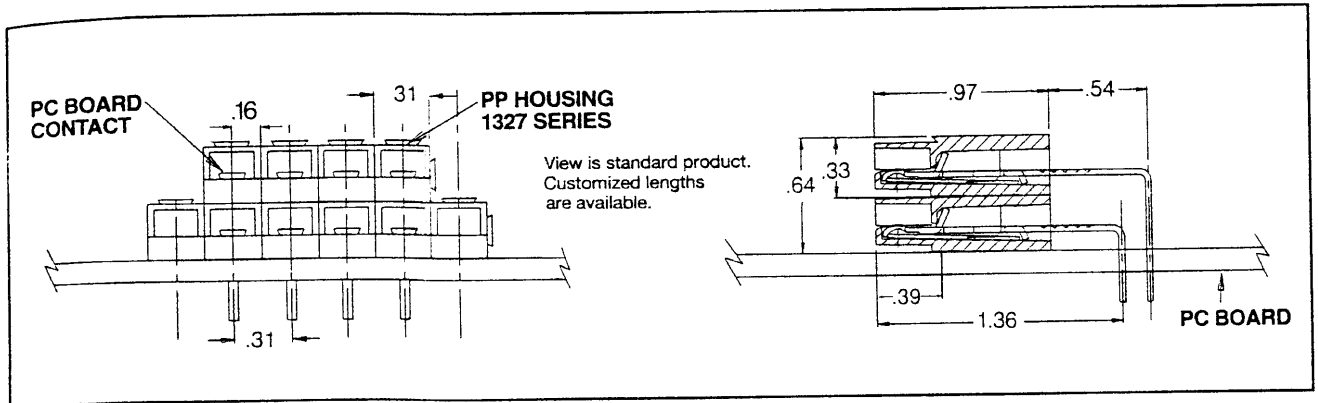

**25 AMP PRINTED CIRCUIT BOARD  
CONNECTOR INTERFACE TEMPERATURE RISE  
POWER INPUT FROM POWERPOLE 30 WITH 12 AWG WIRE**

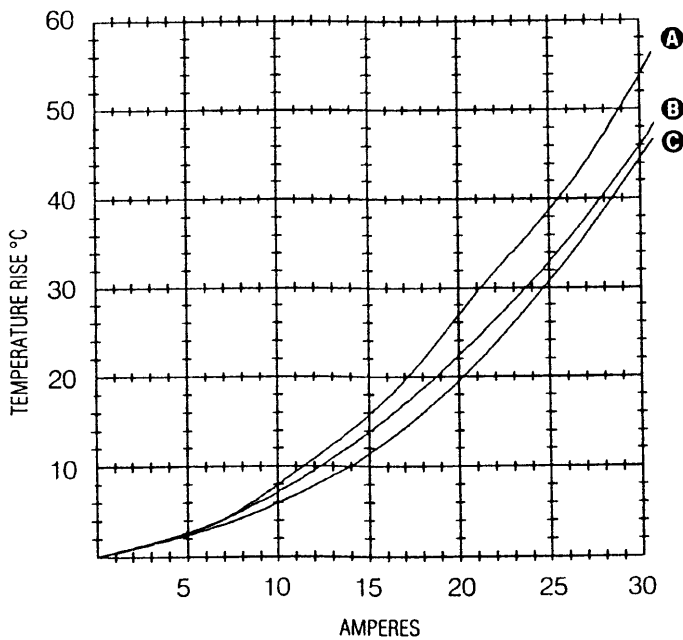

- A = 2 CONDUCTORS SPACED .03" APART
  - B = 2 CONDUCTORS SPACED .3" APART
  - C = 1 CONDUCTOR
- CONDUCTORS = .002 SQ. IN.

*For equivalent millimeter wire sizes, reference the "Conversion Chart of American Wire Gauge to Metric System" in this section. Contact Anderson Power Products or authorized representative for graphs of wire sizes not shown.*

# Powerpole® Modular Connectors

**B**

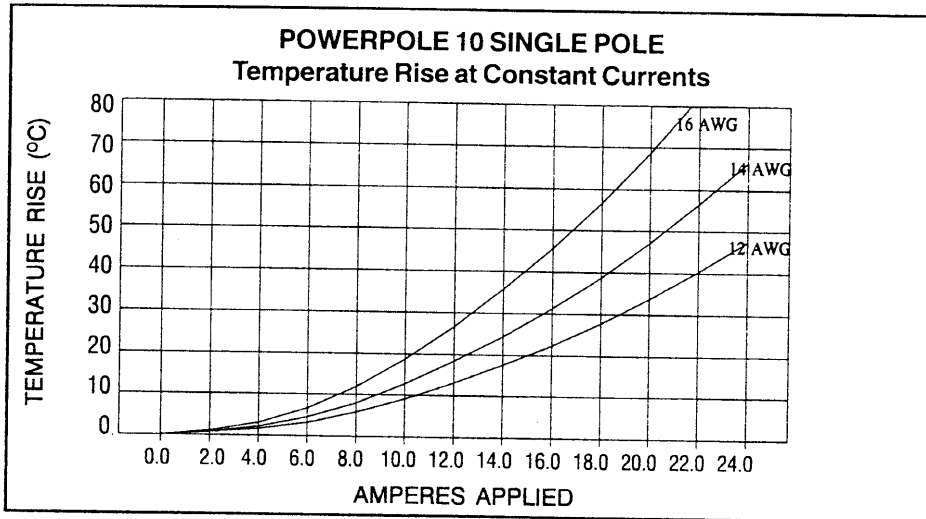

(Figure 1)

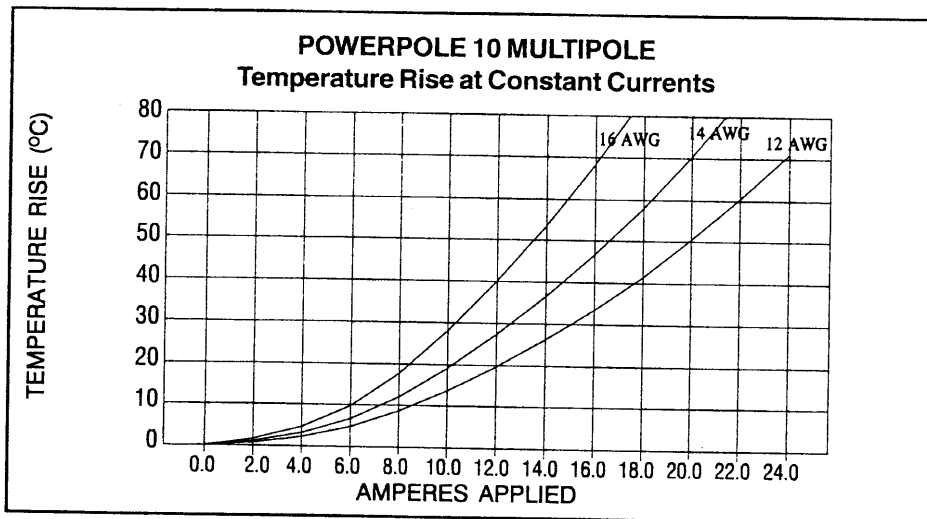

(Figure 2)

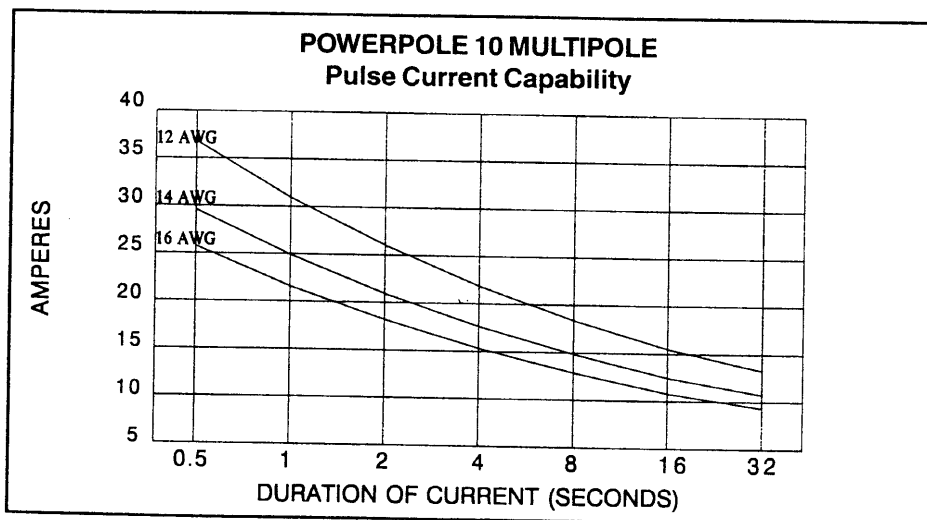

(Figure 3)

For equivalent millimeter wire sizes, reference the "Conversion Chart of American Wire Gauge to Metric System" in this section. Contact Anderson Power Products or authorized representative for graphs of wire sizes not shown.

# Powerpole® Modular Connectors

B

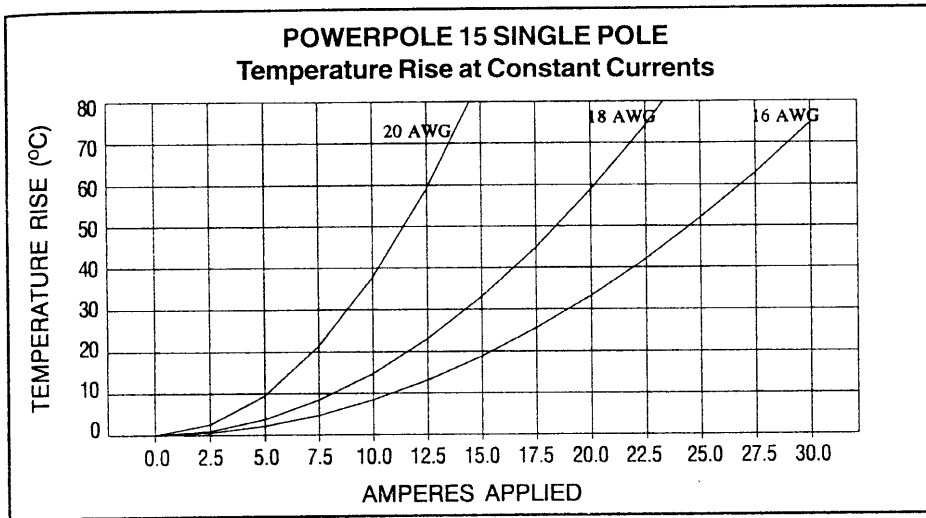

(Figure 4)

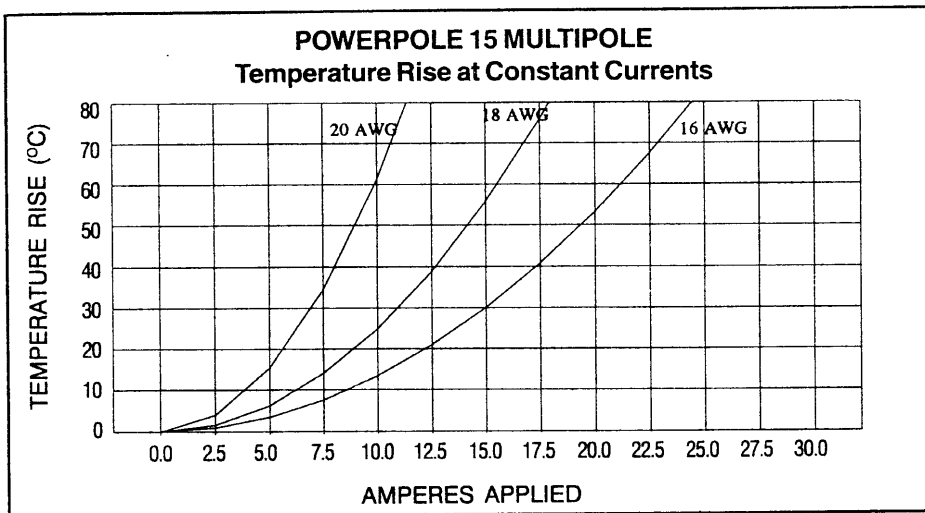

(Figure 5)

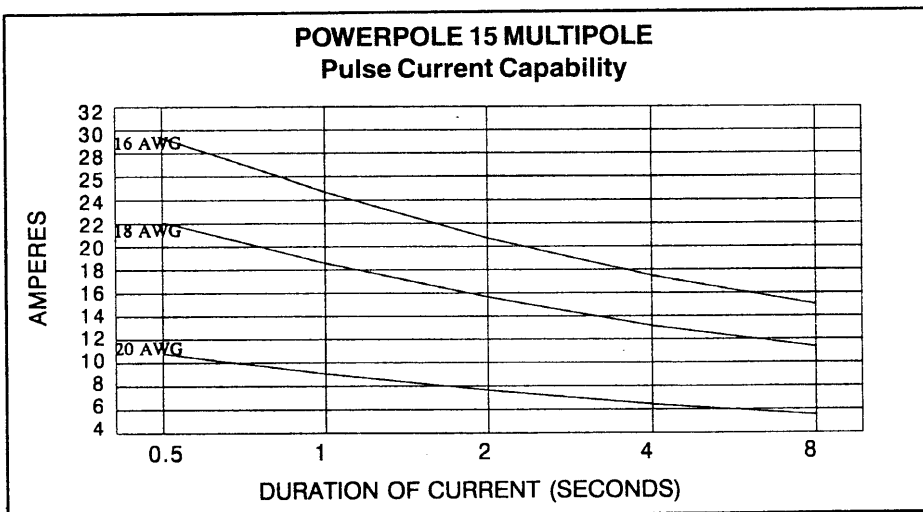

(Figure 6)

For equivalent millimeter wire sizes, reference the "Conversion Chart of American Wire Gauge to Metric System" in this section. Contact Anderson Power Products or authorized representative for graphs of wire sizes not shown.

# Powerpole® Modular Connectors

**B**

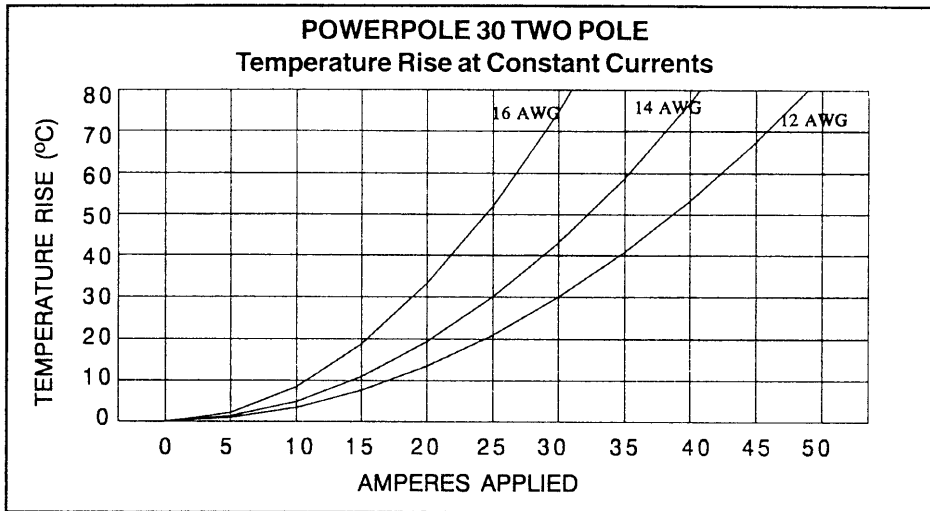

(Figure 7)

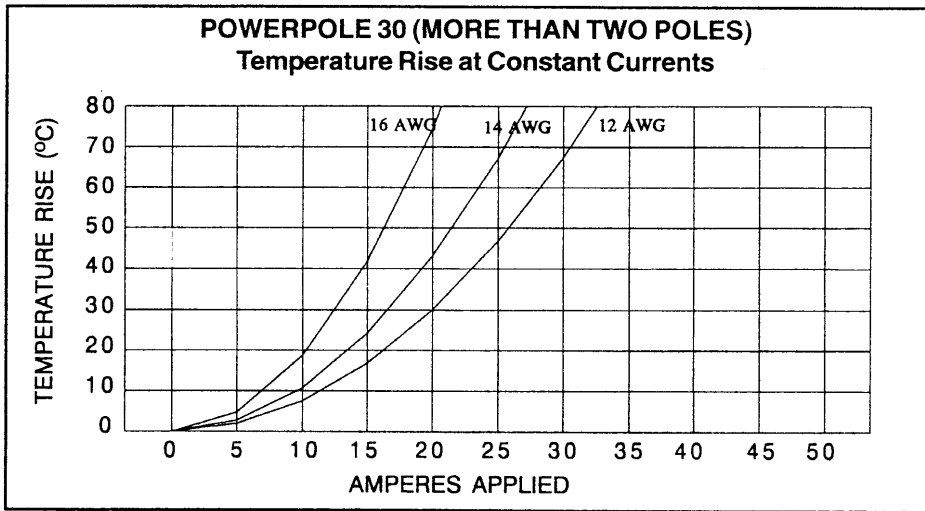

(Figure 8)

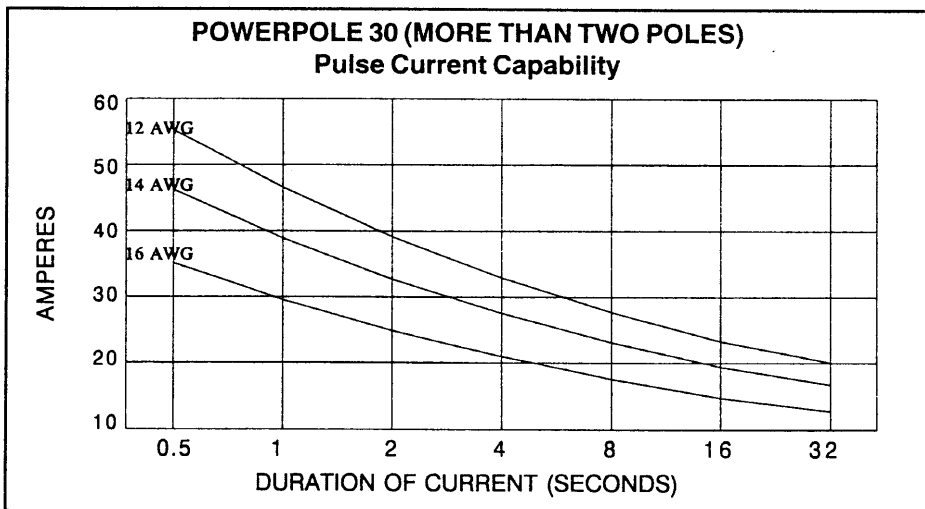

(Figure 9)

For equivalent millimeter wire sizes, reference the "Conversion Chart of American Wire Gauge to Metric System" in this section. Contact Anderson Power Products or authorized representative for graphs of wire sizes not shown.



# Powerpole® Modular Connectors

B

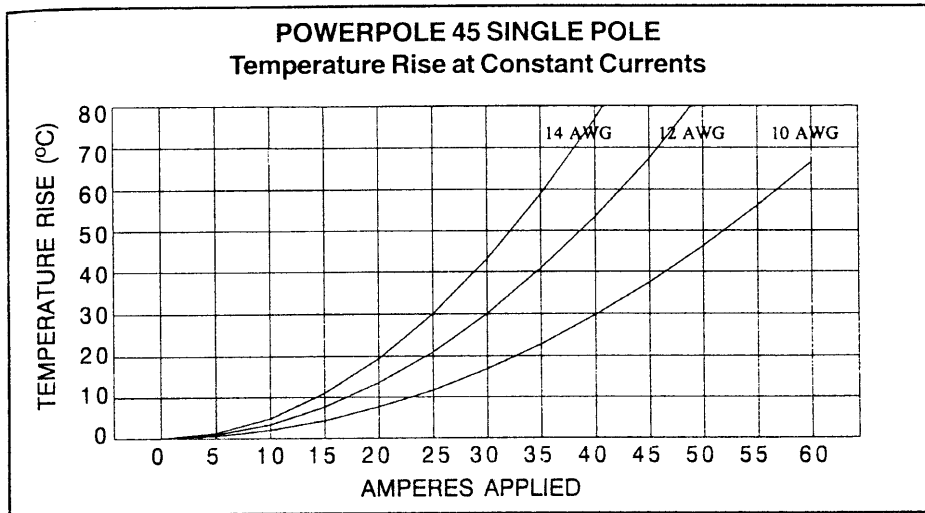

(Figure 10)

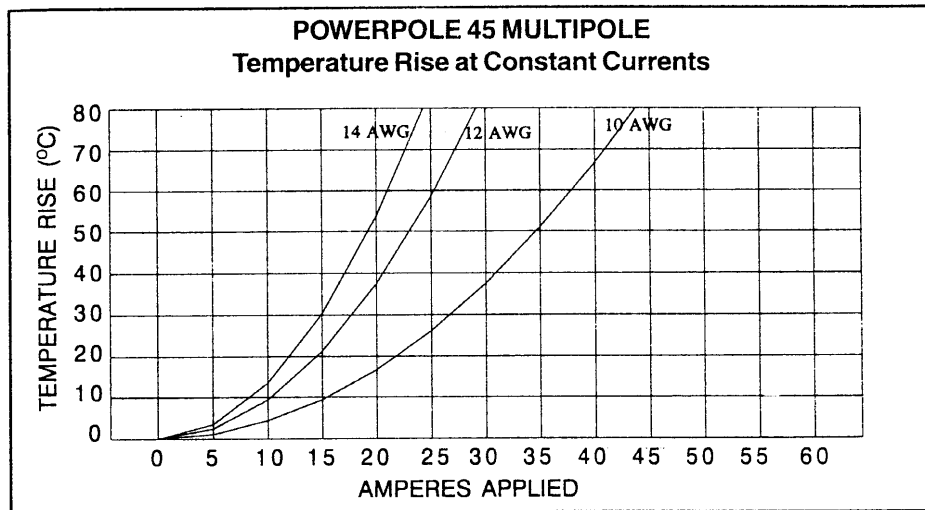

(Figure 11)

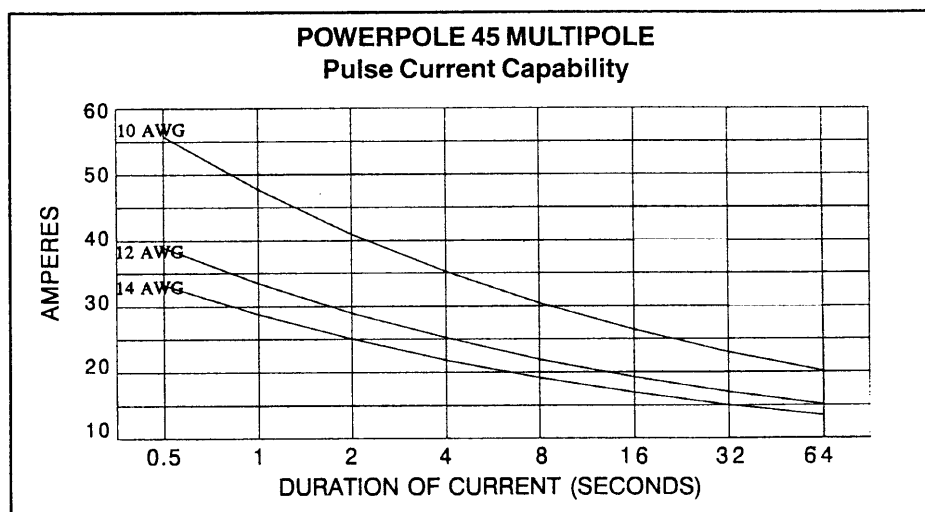

(Figure 12)

For equivalent millimeter wire sizes, reference the "Conversion Chart of American Wire Gauge to Metric System" in this section. Contact Anderson Power Products or authorized representative for graphs of wire sizes not shown.

# Powerpole® Modular Connectors

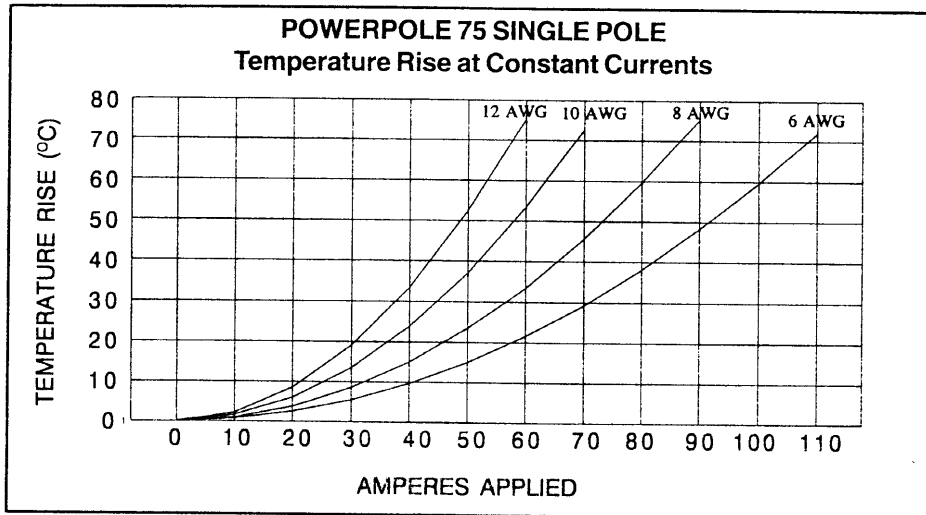

(Figure 13)

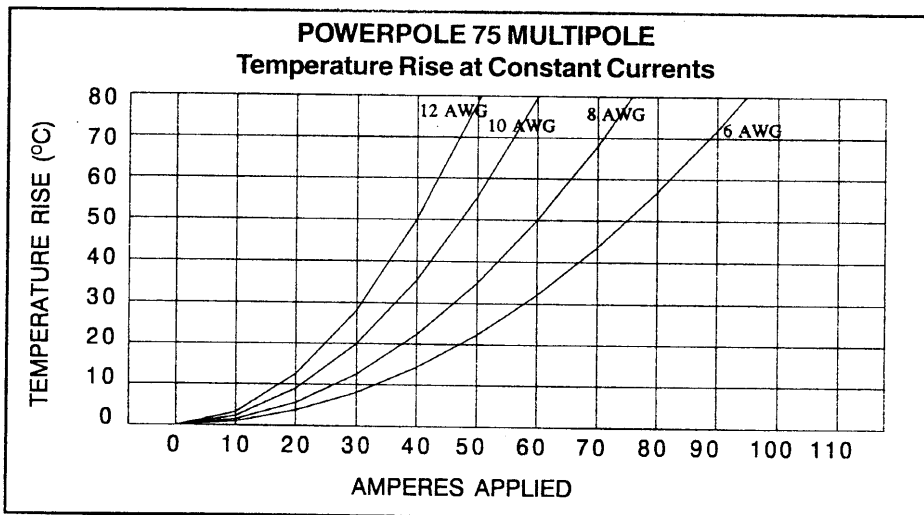

(Figure 14)

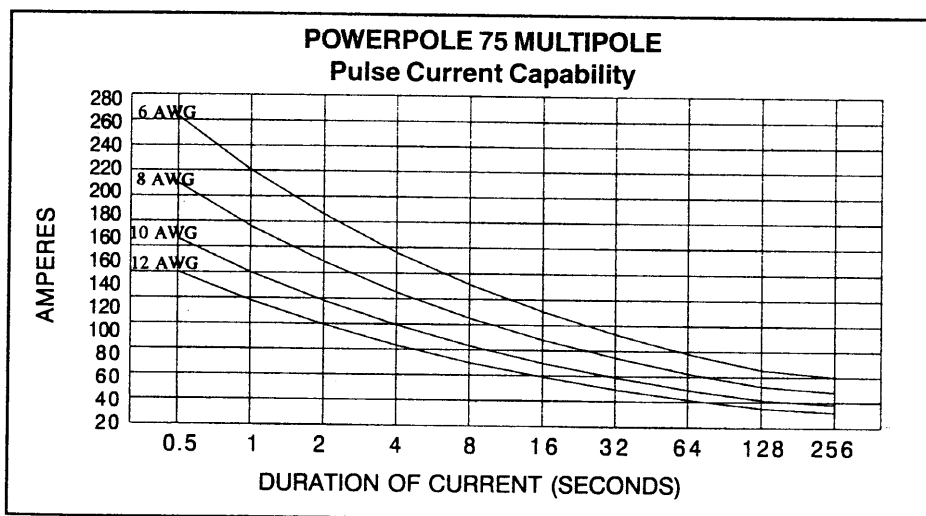

(Figure 15)

For equivalent millimeter wire sizes, reference the "Conversion Chart of American Wire Gauge to Metric System" in this section. Contact Anderson Power Products or authorized representative for graphs of wire sizes not shown.

# Powerpole® Modular Connectors

**POWERPOLE 75 (REEL CONTACT) 1 POLE - SILVER PLATED**  
Temperature Rise at Constant Currents

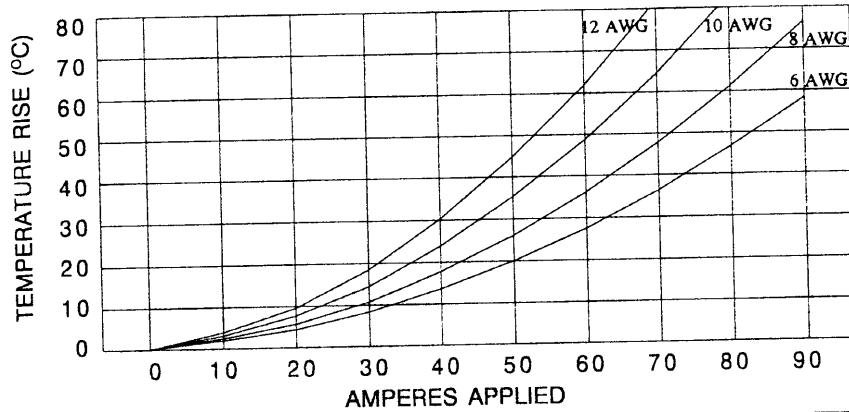

(Figure 16)

**POWERPOLE 75 (REEL CONTACT) MULTIPOLE - TIN PLATED**  
Temperature Rise at Constant Currents

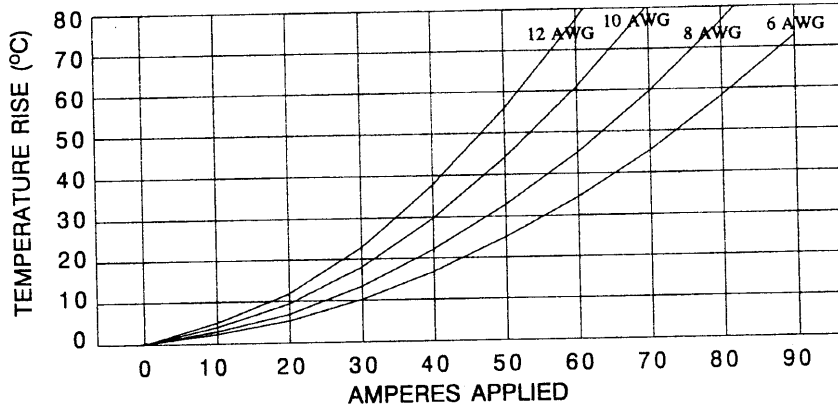

(Figure 17)

**POWERPOLE 75 (REEL CONTACT) MULTIPOLE**  
Pulse Current Capability

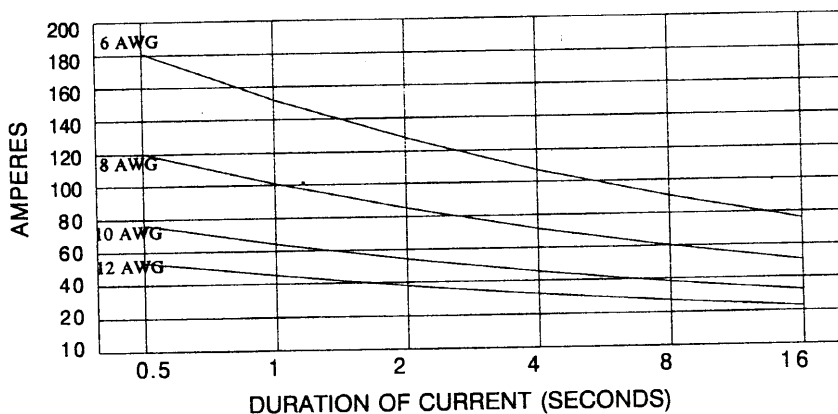

(Figure 18)

For equivalent millimeter wire sizes, reference the "Conversion Chart of American Wire Gauge to Metric System" in this section. Contact Anderson Power Products or authorized representative for graphs of wire sizes not shown.

# Powerpole® Modular Connectors

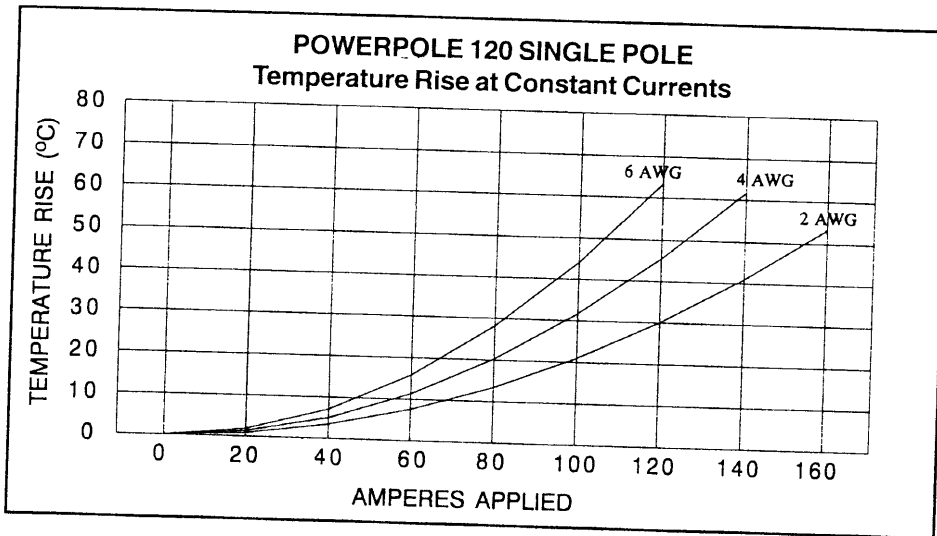

(Figure 19)

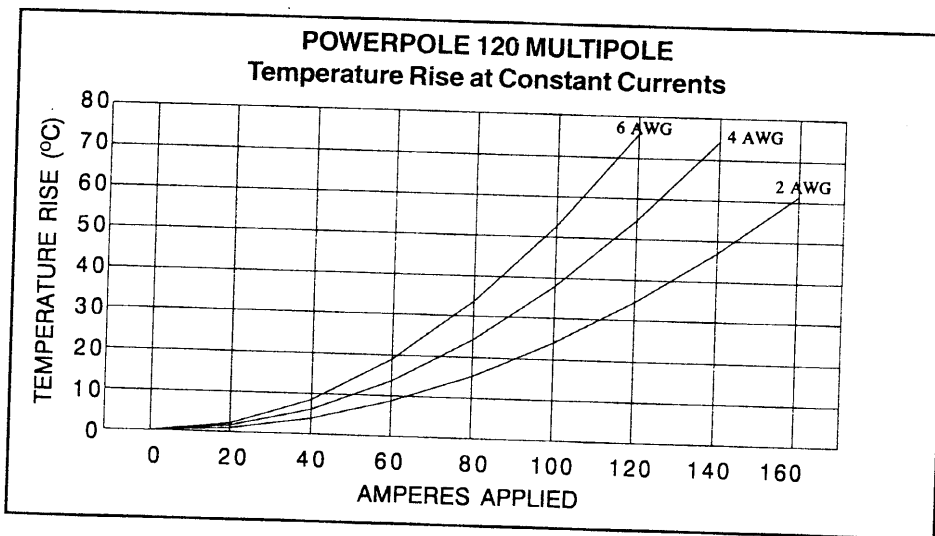

(Figure 20)

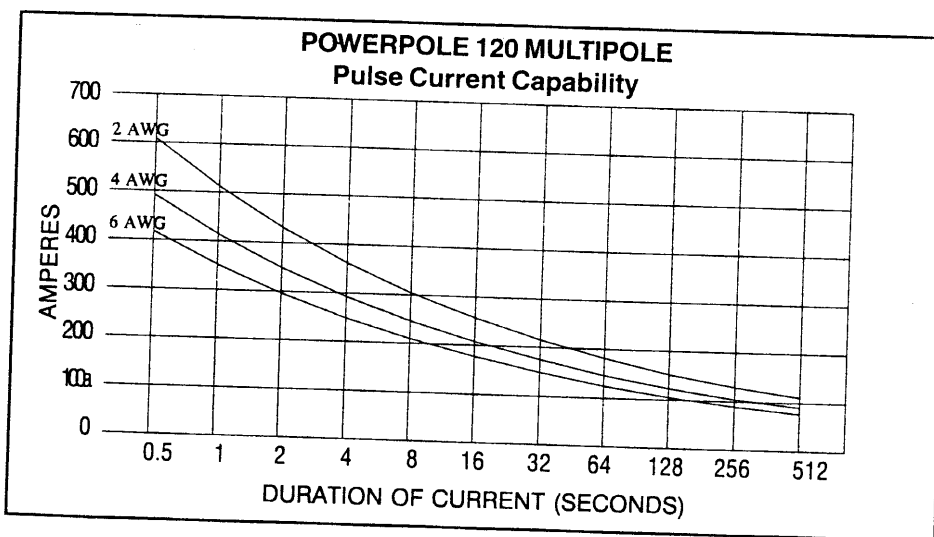

(Figure 21)

For equivalent millimeter wire sizes, reference the "Conversion Chart of American Wire Gauge to Metric System" in this section. Contact Anderson Power Products or authorized representative for graphs of wire sizes not shown.

# Powerpole® Modular Connectors

B

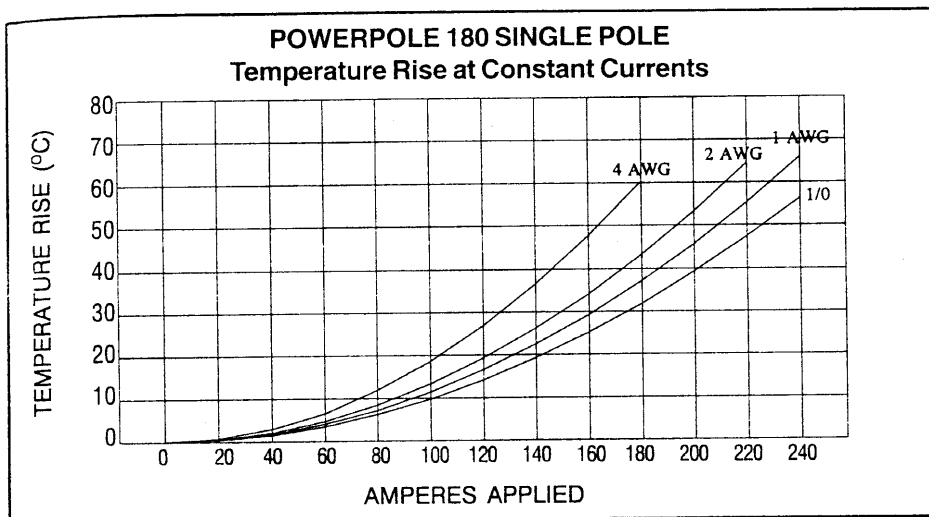

(Figure 22)

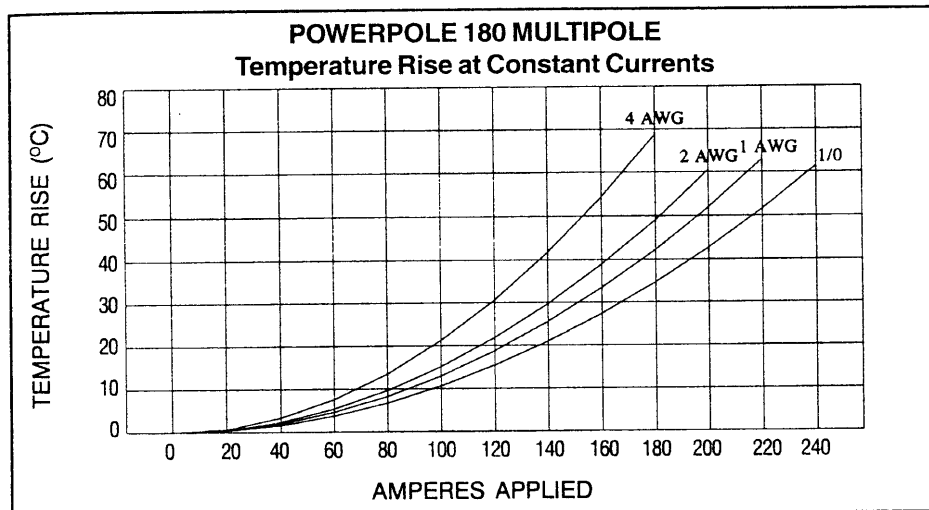

(Figure 23)

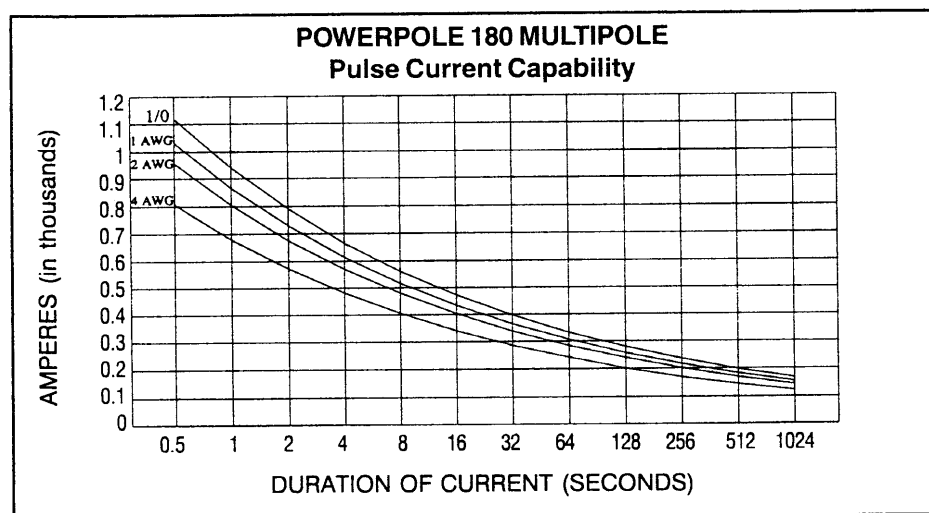

(Figure 24)

For equivalent millimeter wire sizes, reference the "Conversion Chart of American Wire Gauge to Metric System" in this section. Contact Anderson Power Products or authorized representative for graphs of wire sizes not shown.