

In addition to all the unique features of our standard PP75 Powerpoles®, we offer a "Locking" version. The locking clips insure that the connector dovetails are attached securely without roll pins, which are required to secure other Powerpole® assemblies. Like our standard Powerpole® housing, the locking PP75 also offers a 600 Volts continuous, AC or DC operation. Wire sizes range from #6 to #16 AWG (13.3 to 1.3 mm²). The locking PP75 utilizes the same contacts and crimp tooling as our standard PP75 housing.

FEATURES

- Locking dovetail design**
Provides positive mechanical spring latch, creating lockable/unlockable modules
- Horizontal/Vertical mounting wings or surface adaptor**
Eliminates retaining pins, allows horizontal, vertical or direct mounting capability
- Molded-in dovetails**
Securely locks modules into multipole configurations

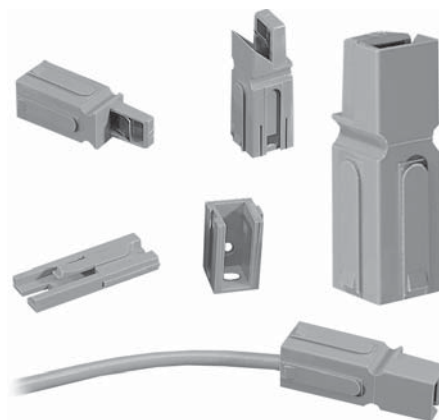

PRODUCT SPECIFICATIONS

Connector Model	PP75	Connector Model	PP75
UL Current Rating (Amperes)*	75****	Life	
UL Voltage Ratings (Volts)**	600*	a. No load (Contact/Disconnect Cycles)	To 10,000
Contact Barrel Wire Size (AWG)	#6 to #16	b. Under Load (Hot Plug 250 cycles @ 120V)	50A
(mm)	13.3 to 1.3	Avg. Connection/Disconnect (lbs)	7
Maximum Wire Insulation Diameter (inches)	0.437	Operating Temperature Range °C***	-20° to 105°
(mm)	11.10	°F	-4° to 221°
AVG Contact Resistance* (micro-ohms)	200	Flammability Rating of Housing Material	UL94 V-0
Insulation Withstanding Test Voltage (Volts AC/DC)	2200		
Contact Retention Force (lbs)	50		

* UL Rated for 65°C rated wire or cable size
** Both AC & DC Voltage
*** Contact factory for higher temperature rated connectors
**** For 75°C rated wire or cable size

ORDERING INFORMATION

Housing Only

Part Number	Description
75LOKBLU	Blue housing
75LOK45BLU	45° locking housing
75LOK90BLU	90° locking housing

When ordering additional colors, replace the last 3 letters to reflect your color preference: Black - BLK; White - WHT; Green - GRN; Red - RED

75 amp Contacts

Part Number	Description	Wire	
		AWG	sq. mm
1307	Individual, low detent	#6	13.3
5900	Individual, high detent	#6	13.3
5914	Individual, high detent	#10	5.3

contacts continued

Part Number	Description	Wire	
		AWG	sq. mm
5915	Individual, high detent	#10/12	5.3/3.3
5952	Individual, high detent	#8	8.4
5953	Individual, low detent	#10/12	5.3/3.3
904G1	Set of (2) 5915 Contacts	#10/12	5.3/3.3
903G1	Set of (2) 5900 Contacts	#6	13.3
265G1	Reel, high detent, silver	#6/8	13.3/8.4
265G2*	Reel, high detent, silver	#10/12	5.3/3.3
265G3	Reel, low detent, silver	#6/8	13.3/8.4
265G4*	Reel, low detent, silver	#10/12	5.3/3.3
265G5	Reel, high detent, tin	#6/8	13.3/8.4
265G6**	Reel, high detent, tin	#10/12	5.3/3.3
265G7	Reel, low detent, tin	#6/8	13.3/8.4
265G8**	Reel, low detent, tin	#10/12	5.3/3.3
75BBS	75 amp bus bar contact	N/A	N/A

* Using 10/12 AWG wire reduces rating to 50 amps
** Using 10/12 AWG wire reduces rating to 40 amps

Accessories

Part Number	Description
1463G1	2 & 4 pole mounting clamp set
1463G2	3 & 6 pole mounting clamp set
75 LOKSMTBLU	Surface mounting pad
75LOKWNGBLU	Mounting wing (oval hole)
75LOKWNGBLU-R	Mounting wing (round hole)
110G57	Lock nut for use with bus bar contact

Bushings

Part Number	AWG	Wire
		sq. mm
Use with 5900 or 1307		
5910	#6 to #10/12	13.3 to 5.3/3.3
5912	#6 to #8	13.3 to 8.4
5913	#6 to #8	13.3 to 2.1/1.3

...continued on back page

ORDERING INFORMATION

Tooling

Part Number	Description
1309G4	Hand tool, #16 to #6
1387G1	Pneumatic tool, #16 to #6
1388G6	- die for #16 to #6 AWG
1388G7	- die for #10 to #12 AWG (5914, 5915 & 5953 contacts)
1389G6	- locator for #16 to #6 AWG
1389G7	- locator for #10 to #12 AWG (5914, 5915 & 5953 contacts)
260G16	Applicator only (110V & 220V)
284G1	Applicator & Press (220V, 50Hz)
250G5	Press only (110V, 60Hz)

DIMENSIONS

Housings

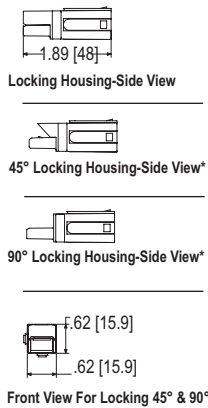

Mounting Wings

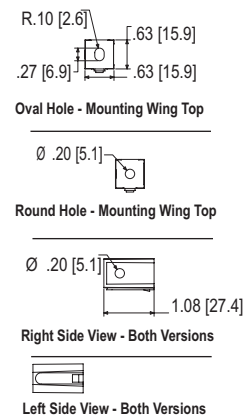

Surface Mount Pad

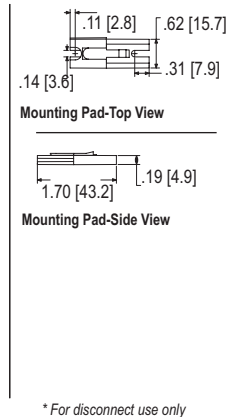

* For disconnect use only

Contacts

Part Number	-A-		-B-		-C-		-D-		-E-		-F-	
	mm	in.	mm	in.	mm	in.	mm	in.	mm	in.	mm	in.
1307	30.0	1.18	7.2	0.28	5.6	0.22	11.4	0.45	7.1	0.28	N/A	N/A
5900	30.0	1.18	7.2	0.28	5.6	0.22	11.4	0.45	7.1	0.28	N/A	N/A
5914	29.7	1.17	4.8	0.19	3.5	0.14	11.4	0.45	7.1	0.28	N/A	N/A
5915	30.0	1.18	7.2	0.28	3.5	0.14	11.4	0.45	7.1	0.28	N/A	N/A
5952	30.0	1.18	7.2	0.28	4.7	0.19	11.4	0.45	7.1	0.28	N/A	N/A
5953	30.0	1.18	7.2	0.28	3.5	0.14	11.4	0.45	7.1	0.28	N/A	N/A
904G1	30.0	1.18	7.2	0.28	3.5	0.14	11.4	0.45	7.1	0.28	N/A	N/A
903G1	30.0	1.18	7.2	0.28	5.6	0.22	11.4	0.45	7.1	0.28	N/A	N/A
265G1	31.8	1.25	9.1	0.36	9.1	0.36	22.9	0.90	8.1	0.32	N/A	N/A
265G2	31.8	1.25	7.4	0.29	6.9	0.27	22.9	0.90	8.1	0.32	N/A	N/A
265G3	31.0	1.22	9.1	0.36	9.1	0.36	22.9	0.90	8.1	0.32	N/A	N/A
265G4	31.0	1.22	7.4	0.29	6.9	0.27	22.9	0.90	8.1	0.32	N/A	N/A
265G5	31.8	1.25	9.1	0.36	9.1	0.36	22.9	0.90	8.1	0.32	N/A	N/A
265G6	31.8	1.25	7.4	0.29	6.9	0.27	22.9	0.90	8.1	0.32	N/A	N/A
265G7	31.0	1.22	9.1	0.36	9.1	0.36	22.9	0.90	8.1	0.32	N/A	N/A
265G8	31.0	1.22	7.4	0.29	6.9	0.27	22.9	0.90	8.1	0.32	N/A	N/A
75BBS	68.6	2.70	17.0	0.67	6.9	0.27	#10-24 thd.	1.0	0.04	2.0	0.08	

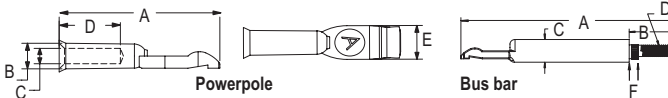

Bushings - (for use with 5900 or 1307)

Part Number	Reduces From	-A-		-B-		-C-	
		mm	in.	mm	in.	mm	in.
5910	#6 to #10-12 AWG	11.9	.47	5.4	.21	3.5	.14
5912	#6 to #8 AWG	11.4	.45	5.4	.21	4.6	.18
5913	#6 to #14-16 AWG	11.9	.47	5.4	.21	2.4	.09



TEMPERATURE RISE CHARTS

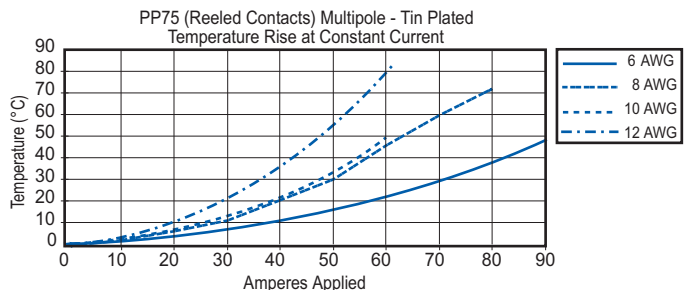
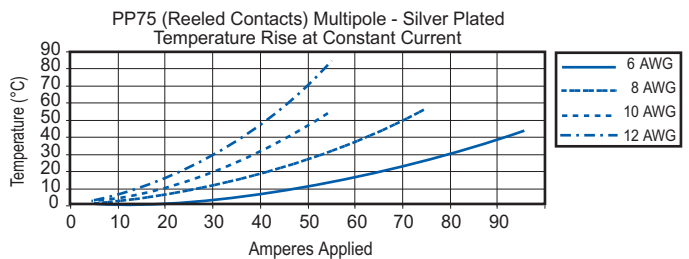
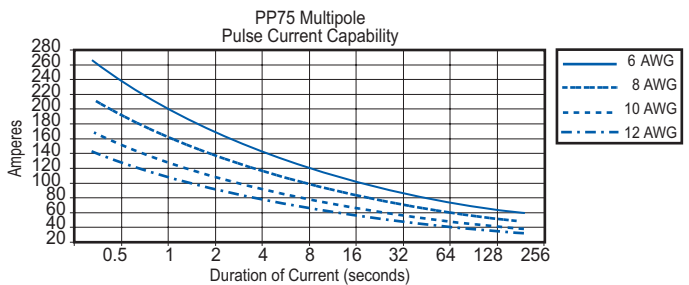
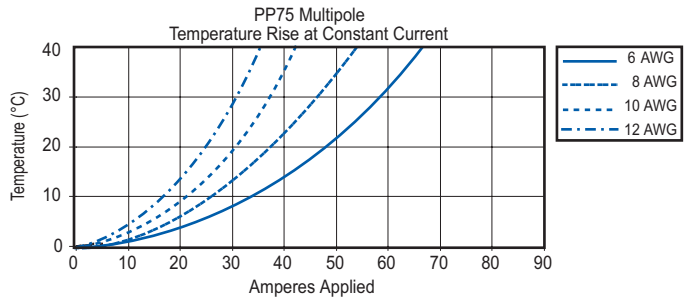
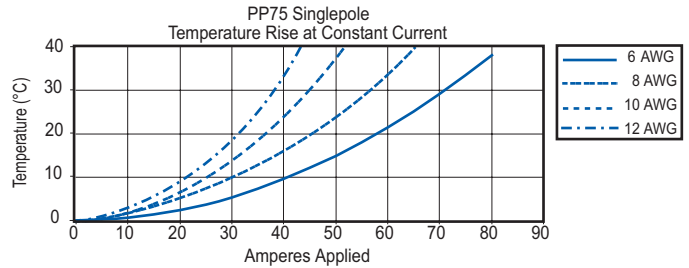

All Data Subject To Change Without Notice

DS-PP75LOK REV02