

electromagnetic  
**integrated  
solutions**

short form catalog



**api**   
technologies corp.  
*Spectrum Control*

# *Electromagnetic Integrated Solutions*

API Technologies has been the world's leading provider of custom application-specific EMI filter solutions since 1968. Through our Spectrum Control line we offer a wide range of standard products and we will develop a new or modified product or integrated assembly to help you address the mechanical, electrical and/or power requirements of your next design. Our family of Electromagnetic Integrated Solutions includes not only the industry's most complete line of coaxial EMI components, power surface mount filters, filtered connectors, filtered arrays, power filters and EMC testing services, but also an expanded offering of ceramic capacitors, filtered and unfiltered interconnects, and magnetics.

## Table of Contents:

<b>EMI Filter Solutions</b> . . . . .	<b>2-3</b>
<b>Integration, Global &amp; Technical Resources</b> . . . . .	<b>4-5</b>
<b>Product Applications</b> . . . . .	<b>6-7</b>
<b>EMC Test Capabilities</b> . . . . .	<b>8-9</b>
<b>Ceramic Capacitors</b> . . . . .	<b>10-16</b>
<b>Coaxial Filters &amp; Interconnects</b>	
<b>Surface Mount EMI Filters</b> . . . . .	<b>17-21</b>
<b>Low Pass EMI Filters</b> . . . . .	<b>22-29</b>
<b>EMI Filtered Arrays</b> . . . . .	<b>30-36</b>
<b>EMI Filtered Connectors</b> . . . . .	<b>37-45</b>
<b>QuietShield Caskets &amp; Shielding</b> . . . . .	<b>46-47</b>
<b>Specialty Connectors &amp; Custom Cable Assemblies</b> . . . . .	<b>48-53</b>
<b>Power Filters</b> . . . . .	<b>54-63</b>
<b>Magnetics</b> . . . . .	<b>64-66</b>

## Innovative Solutions from Components to Complex Assemblies

Understanding how and where potential EMI problems exist in an electronic system can be a daunting challenge. Uncovering the best way to address both conducted and radiated EMI by understanding all the mechanical, electrical and environmental concerns of your system can reduce costs and keep a project on budget and schedule. Our extensive library of standard components, which we frequently develop into custom assemblies, offers you a more complete, high performance solution... saving you time and money.

## Industry's Broadest Line of Standard Products

We offer the flexibility to filter EMI at the power source, at the I/O connection, in a barrier wall or on the PCB. Our industry-leading line, including inductors, glass and resin sealed filters, SMT filters, filter plates, filtered connectors, power entry and power line filters, military/aerospace multi-section filters, ceramics and magnetics, gives you a wide range of size, performance and packaging options, most available RoHS compliant. In addition, we have over 800 standard MIL QPL products and DSCC part numbers.

## Custom Application-Specific Solutions

This phrase serves as an excellent summary of what we produce for our customers, as well as defines what distinguishes our company from others in the electronics market. Rarely does a 100% off-the-shelf component completely satisfy the mechanical, electrical, and/or power requirements and constraints of a sophisticated OEM design. Whether modifying an existing component, working from a "clean sheet" approach, or integrating various technologies into a subassembly or system, the result will be a tailored API Technologies' Spectrum Control design for your exact application parameters, one that pushes the envelope of product performance.

As the world leader in EMI products and a market leader in microwave and power products, our customers rely on us to create and provide optimized solutions that improve their competitive advantage.





## *Product Families*

### **Ceramic Capacitors**

- Discoidal capacitors
- SMPS modular capacitors
- Planar capacitors
- Tubular capacitors



### **Coaxial Filters & Interconnects**

- Resin and hermetically sealed filters
- High current/high voltage filters
- Miniature hermetically sealed and surface mount filters
- Filter plates and terminal blocks
- D-sub and combo filtered connectors
- Ribbon and datacomm connectors
- Rugged USB connectors



### **Specialty Connectors & Custom Cable Assemblies**

- Circular connectors
- Mini-MIL and Rapid Mate connectors
- Audio and glass sealed connectors
- Value-added terminations and harnesses
- Custom cable assemblies



### **EMI Power Filters**

- Commercial power filters
- Military/aerospace power filters
- Power entry modules
- Power Line Filters



### **Magnetics**

- Current transformers
- Power transformers
- Inductors, chokes and filters
- Switch mode power supply inductors
- Modem and module transformers
- Air coils

## Vertical Integration

API's business teams coordinate and share extensive in-house resources to support many of the problem-solving designs and value-added programs we create. Internal capabilities range from formulating and producing the ceramics used in many of our products to complete metal fabrication, which facilitates the mechanical/packaging requirements of our customers' designs. Specific technologies are sourced from multiple locations using expertise found throughout our organization, often crossing business segments to find the ideal production method, including use of our MIL-STD-790 and TS16949 certified factories.

## Low Cost Manufacturing Centers

ISO9001:2008 certified API Technologies adheres to world class manufacturing techniques ensuring each customer receives the Six Sigma reliability they demand. In response to the realities of the marketplace, we have established low cost manufacturing facilities in China and Mexico. These new plants complement our North American production capacity and flexible manufacturing systems, allowing us to ramp-up production to meet fast-track delivery requirements.

## Global Reach

Today, more than ever, it is imperative suppliers be prepared to support their customers around the world. API Technologies has created a network of sales and design centers, manufacturing plants and distribution facilities to support the world's major markets. From field sales specialists to engineering and manufacturing to logistics, we have moved our key program development personnel closer to our customers regardless of their location. We are committed to being a player in the global economy and ideal partner for our worldwide OEM customers.





# Engineering & Technology Leader

The heritage of our company, dating to its founding in 1968, is as an engineering driven, solutions provider. Through the years of expansion and acquisition, this basic premise remains a constant and driving force. Our teams of experienced application engineers use sophisticated simulation software to replicate real-world environments. Once product designs are complete, we conduct exhaustive in-house testing and verification to ensure function and compliance. API Technologies maintains a leadership position in many industries by applying the latest technology to design performance-enhancing products and systems.



## R & D Commitment... Creating the Next Generation

The surest way to guarantee organic new product development is through investment in research personnel and equipment. API Technologies consistently commits the resources necessary to fund the innovation and creativity leading to technological advancements. We constantly are looking for ways to improve existing designs, as well as find entirely new approaches yielding unforeseen benefits. All of our business units have made significant new product introductions in recent years.

# *Optimized Designs*

## **Defense**

- Specialty Connectors
- QPL'd Coaxial Filters
- Military Custom Power Filters
- Ceramic Capacitors
- Magnetics

## **Communications**

- Coaxial Interconnects
- Commercial Custom Power Filters
- Surface Mount Filters
- Magnetics

## **Avionics**

- Specialty Connectors
- Coaxial Filters and Interconnects
- Custom Power Filters
- Magnetics



*for a wide range of new  
applications and markets*

## Alternate Energy

- Specialty Ceramics
- Magnetics

## Medical

- Coaxial Filters and Interconnects
- Ceramic Capacitors
- Power Filters
- Magnetics

## Industrial

- Ceramic Capacitors
- Coaxial Filters and Interconnects
- Specialty Connectors and Custom Cable Assemblies
- Magnetics

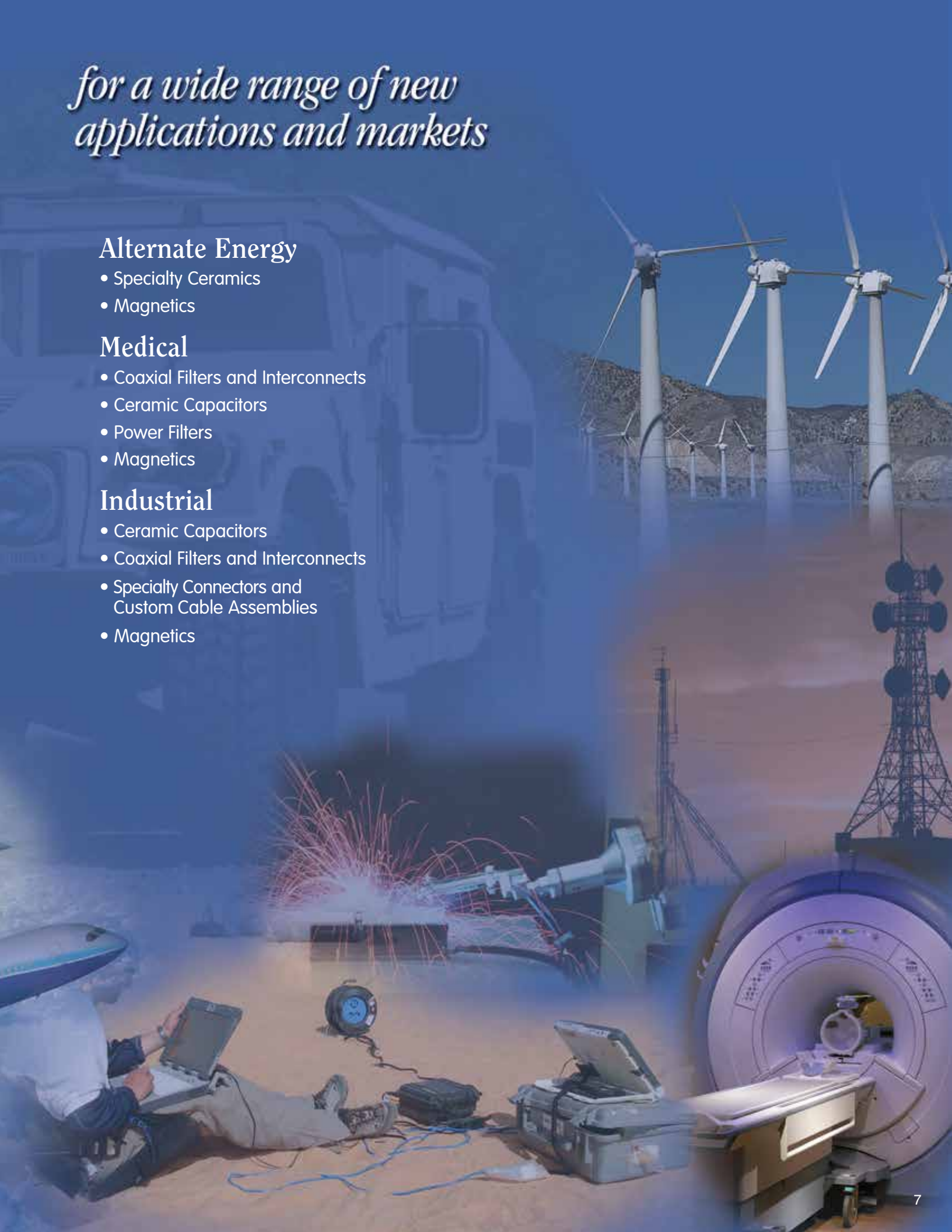

# EMI Testing Services

*API Technologies has the EMC expertise and in-house filter solutions you need to meet worldwide EMC standards.*

Our EMC testing services offer you a flexible resource to assist in product development by identifying and correcting EMI susceptibility and/or emission problems. API has a fully equipped EMC testing laboratory and an experienced engineering staff ready to solve demanding EMC challenges. For a modest daily fee, we can test your equipment, determine state of compliance, and work with you in developing a viable solution. It is not uncommon for clients to leave our lab with a prototype in hand.

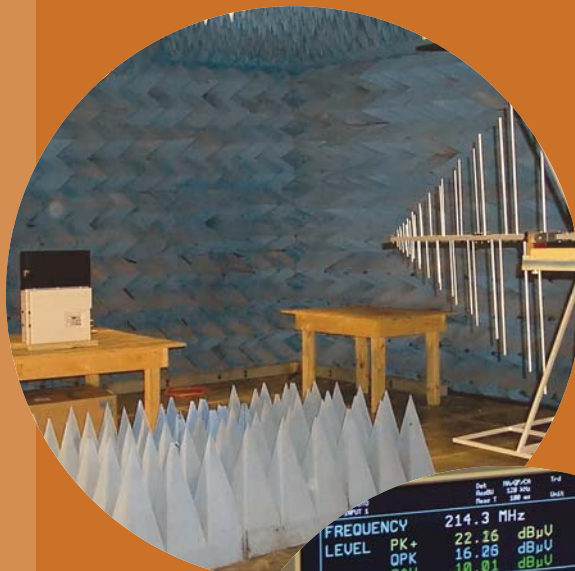

## EMC Lab Highlights

- NARTE certified staff
- Semi-anechoic chamber
- Computer controlled instrumentation
- Graphical data presentation in multiple formats
- Fiber optic video monitoring system

## Testing Capabilities

### MILITARY

MIL-STD-461 A/B/C/D/E

MIL-STD-1399

### AUTOMOTIVE

CISPR 25 Test Methods

### COMMERCIAL

FCC-Part 15

RTCA/DO-160 A/B/C/D

GR-1089-CORE

### INTERNATIONAL

EN55011/CISPR 11

EN55014/CISPR 14

EN55022/CISPR 22

EN61000-4-2 Electrostatic Discharge

EN61000-4-3 Radiated RF Immunity

EN61000-4-4 Electrical Fast Transient

EN61000-4-5 Surge

EN61000-4-6 Conducted RF Immunity





# EMI/RFI Filter and Capacitor Performance Testing

## Reliability Levels

### Class B

Class B is outlined in MIL-PRF-28861 and is prescribed for most military/aerospace requirements. It is more stringent than MIL-PRF-15733, requiring 100% screening that includes thermal shock, voltage conditioning and x-ray.

Periodic Group B testing is performed on units selected at random from production lots.

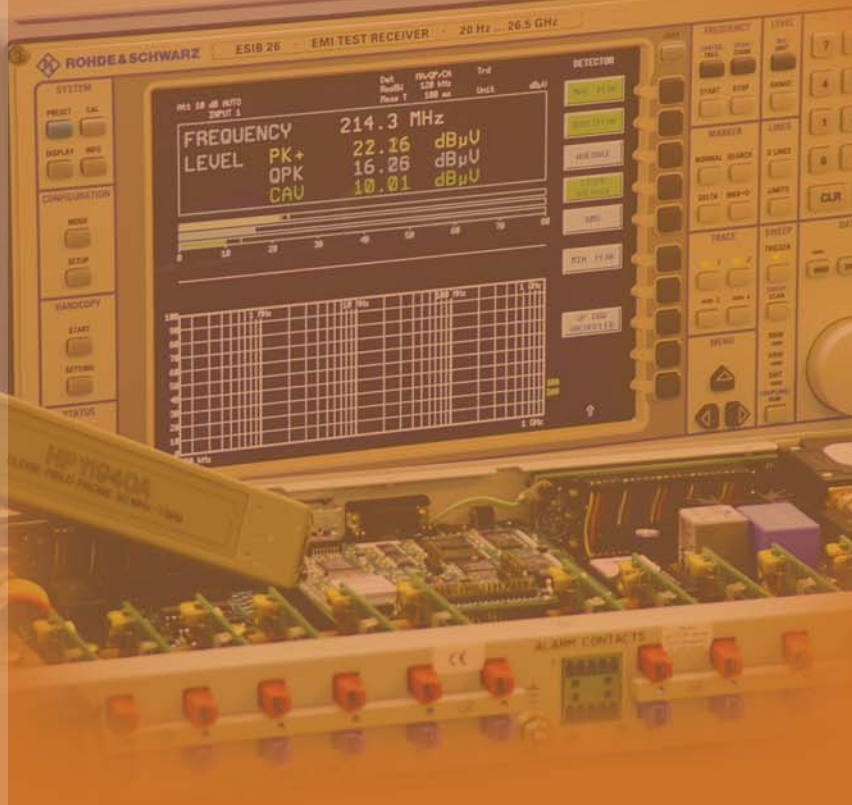

## Class B MIL-PRF-28861 Test Sequence Summary

Inspection	Class B
<b>Group I</b>	
AC voltage drop (when applicable)	X
Voltage and temperature limits of capacitance	X
Insertion loss (at temperature)	X
Barometric pressure (reduced)	X
Temperature rise	X
Current overload	X
Terminal strength	X
Thermal shock and immersion	X
<b>Group II</b>	
Subgroup 1	
Life	X
Subgroup 2	
Resistance to soldering heat	X
Salt spray (corrosion)	X
Radiographic inspection	X
Subgroup 3	
Resistance to solvents	X
<b>Group III</b>	
Shock (specified pulse)	X
Vibration (high frequency)	X
Moisture resistance	X
Seal (when applicable)	X
Radiographic inspection	X

### "R" level testing

"R" level screening is performed by API Technologies' Hi-Rel Laboratory as detailed below. Customers requiring special tests may order to their own specifications or simply order to level R and then note additions or deviations.

### "R" level test sequence

(100% testing unless otherwise specified)

- Thermal Shock: 5 cycles from -55°C to +125°C in accordance with MIL-STD-202, Method 107D, Condition A.
- Burn-in: 100 hours at 1.4x rated DC voltage, 125°C.
- Seal Test: MIL-STD-202, Method 112, Test Condition A. Hermetic sealed parts only.
- Capacitance and Dissipation Factor: MIL-STD-202, Method 305, frequency 1kHz.
- Dielectric Withstanding Voltage: 2.5 times the rated DC voltage for 5 ±1 second at 25°C, with 50 mA maximum charging current.
- Insulation Resistance: MIL-STD-202, Method 302, 125°C at rated DC voltage and room temperature (25°C). The 125°C requirement shall be 10% of the specified catalog IR at 25°C.
- DC Resistance: MIL-STD-202, Method 303.
- Insertion Loss Test: Sample per MIL-PRF-15733. At full rated load in accordance with MIL-STD-220. The minimum insertion loss shall be defined in the filter catalog.
- Visual and Mechanical: In accordance with MIL-PRF-15733.
- Marking: All filters which have successfully completed the test sequence shall be marked with an "R" in the second part of the number. For example, a standard SCI-2130-004 becomes SCI-R2130-004 and 9051-100-0000 becomes 9051-R100-0000, and 51-719-011 becomes 51-R719-011 after completion of the Hi-Rel Level "R" Test Sequence.

# Ceramic Capacitors

*we offer performance and cost alternatives to meet varied voltage, capacitance, packaging and budgetary requirements*



## **Discoidal Feed-Through Capacitors**

are ideal for by-pass and filtering applications with a low inductance construction suited for high frequency applications. Their low profile and rugged design is an excellent alternative to ceramic tubes... 11

## **Tubular Feed-Through Capacitors**

are small, lightweight with high dielectric strength and are impervious to moisture and contamination. Feed-through capacitors have a uniform insertion loss over a broad spectrum range and are ideal for multi-pin connector applications... 12

**Tubular Pi Capacitors** have similar characteristics to feed-through capacitors in addition to a narrower transition between the pass and stop bands, effectively stopping high frequency interference without affecting desired frequencies and providing filtering of noise content close to signal content ... 13

## **SMPS (Switch Mode Power Supply) Capacitors**

deliver lower equivalent series resistance, lower equivalent series inductance, lower ripple voltage and less self-heating when compared to other capacitor technologies... 14-15

**Planar Capacitors** offer a faster assembly time compared to stand-alone chips, discoidal or tubular capacitors. They also have a low profile and are capable of meeting various geometric and electrical configurations, making these planar capacitors the new standard in EMI suppression applications... 16

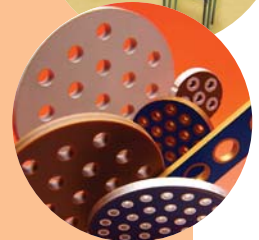

## **API Technologies' Expertise**

Inside every EMI filter is a ceramic feed-through capacitor. The Spectrum Control line of ceramic capacitors is designed to provide solutions to a wide range of filtering applications. Our ceramic capacitors are ideal for EMI/RFI suppression filters, medical implantable devices, commercial and military applications, power supplies and converters.

## **Custom Ceramic Capacitors**

We offer many variations of discoidal, tubular and planar capacitors to fit your custom application:

- Various OD, ID, thickness and length configurations
- Pressed discoidals with surface printed terminals
- Multihole discoidal designs
- Miniature discoidals down to .080" OD

- Arrays
- Custom style capability
- High voltage designs available
- High temperature designs available
- Square tubes for surface mount applications
- Lapped feed-through capacitors



# Discoidal Capacitors

Ceramic discoidal feed-through capacitors are the building blocks of the EMI filter industry. API's Spectrum Control discoidal capacitors provide great versatility in meeting varied voltage, capacitance and dimensional requirements. Our nonpolar, multilayer capacitors are small, reliable and high in dielectric strength. Operational temperatures of -55°C to +125°C are achieved with no voltage de-rating.

The versatile nature of our discoidals makes them ideally suited for by-pass and filtering applications. Due to their low inductance construction, these capacitors perform extremely well in high frequency applications. The circular geometry of a discoidal feed-through capacitor offers many paths to ground, resulting in lower impedance and better filtering performance.

The low profile and rugged design of our discoidal capacitors offer an excellent alternative to ceramic tubes.

## Features

- NPO, X7R and Z5U ceramics
- Excellent high frequency performance
- Low profile design
- Rugged construction
- Low impedance, many paths to ground
- Low inductance, nonpolar
- AC applications up to 240V
- DC applications up to 500V
- -55°C to +125°C operation

## Discoidal Part Numbering System

Example: **340055AX145P6B0**

The part number shown represents a discoidal with an O.D. of 0.340" and I.D. of 0.055", with a voltage rating of 50 VDC. The ceramic type will be X7R, capacitance value is 1,400,000 pF with a tolerance of +100, -0%. The termination will be silver and the parts will receive bulk packaging.

340	055	A	X	145	P	6	B	0
<b>Outer Diameter</b>	<b>Inner Diameter</b>	<b>Voltage Rating</b>	<b>Ceramic Code</b>	<b>EIA Cap Code</b>	<b>EIA Cap Tolerance</b>	<b>Termination</b>	<b>Packaging</b>	<b>Special Requirements</b>
Example: 0.340" = 340	Example: 0.055" = 055	A: 50 VDC B: 100 VDC C: 200 VDC E: 500 VDC	N: NP0 X: X7R Z: Z5U	Example: 1,400,000 pF = 145	K: ±10% M: ±20% P: +100 -0% Z: +80 -20%	6: Silver	B: Bulk	0: None D: Class B G: Custom



## Typical Insertion Loss - FT Capacitors

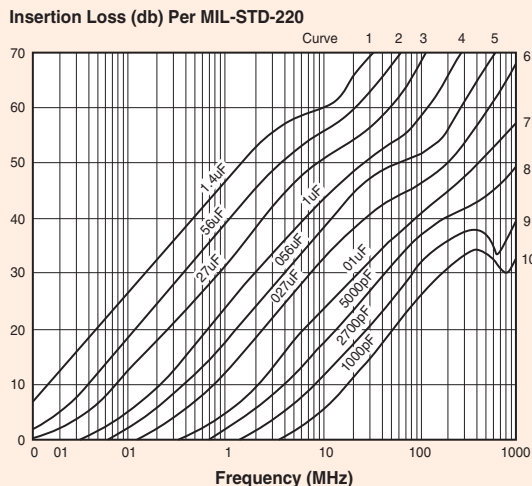

## Multilayer Discoidal

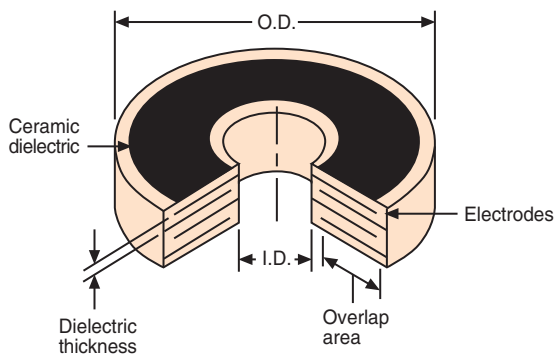

# Tubular Feed-Through (FT) and Pi Capacitors



API's Spectrum Control brand manufactures a wide variety of tubular feed-through (FT) and Pi ( $\pi$ ) ceramic capacitors, which are small in size, lightweight, nonpolar and offer high dielectric strength. Operating temperatures of  $-55^{\circ}\text{C}$  to  $+125^{\circ}\text{C}$  are achieved with no voltage de-rating. All capacitors are fired to produce true monolithic structures, which are impervious to moisture and contamination. Outer terminations feature a nickel barrier and a final metal layer, typically silver.

Ceramic Capacitors

## Features

- Provide filtering of noise content close to signal content
- Low cost solution for general purpose filtering
- Ideal for multipin connector applications
- High ratio of capacitance to volume
- Low inductance, nonpolar
- Impervious to moisture and contamination
- $-55^{\circ}\text{C}$  to  $+125^{\circ}\text{C}$  operation

## Tubular FT Capacitors

Feed-through tubular capacitors are ideally suited for by-pass and filtering applications. Due to the cylindrical design, the capacitors will have uniform insertion loss over a broad frequency range. This structure yields a low inductance when compared to conventional wound capacitors.

Solid FT capacitors have no internal electrodes and find their primary usage in low cost applications. Multilayered FT capacitors have a higher capacitance to volume ratio and are ideally suited for greater filtering at lower frequencies. Multilayered FT capacitors are also designed for applications where source impedances are high and sharp attenuation rise is critical.

## Feed-Through Circuit

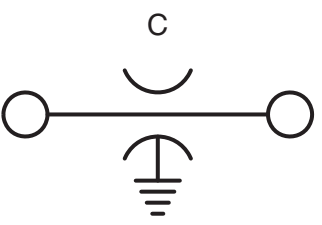

## Typical Insertion Loss

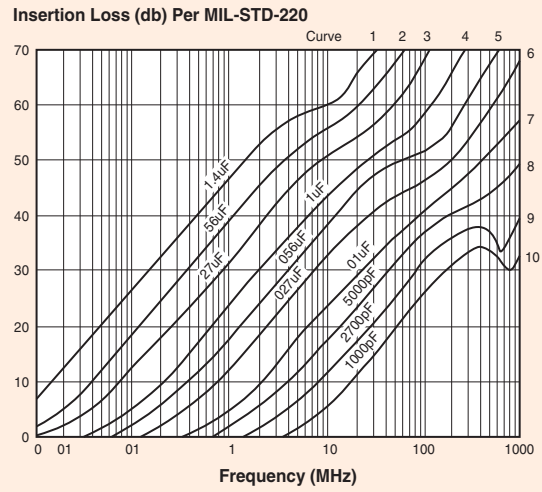

## Feed-Through Construction

### Solid

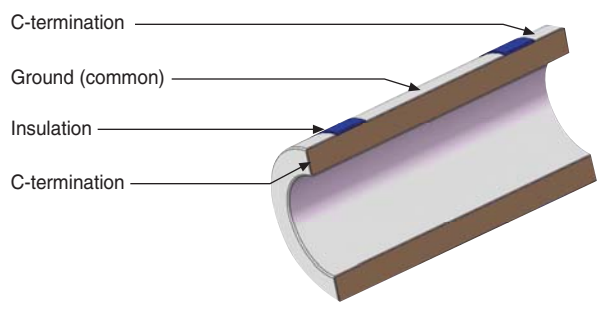

### Multi Layered

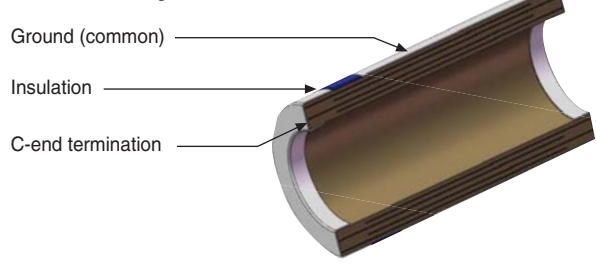



# Tubular Feed-Through (FT) and Pi Capacitors

## Tubular Pi Capacitors

Compared to feed-through tubular capacitors, Pi tubular capacitors have a much narrower transition between the pass and stop bands. Pi capacitors are effective in stopping high frequency interference without affecting necessary frequencies immediately below the stop band.

Similar to feed-through tubular capacitors, Pi tubular capacitors can be designed with a solid or multilayered configuration. Solid Pi tubular capacitors are more cost effective, but limited in capacitance values. Multilayered Pi tubular capacitors can cover a wider range of capacitance, while still maintaining the mechanical strength of a solid Pi tubular capacitor in a similar case size.

### Pi Circuit

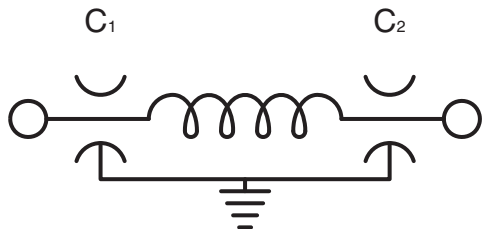

$C_1 + C_2 = C_{Total}$   
Inductive element not included.

## Tubular Part Numbering System

**Example: I8150173X7R471M**

The part number shown represents a Pi tubular capacitor with an O.D. of 0.081" and I.D. of 0.050", with a voltage of 200 VDC. The ceramic type will be X7R, capacitance value is 470 pF with a tolerance of ±20%. The termination will be silver and the parts will receive bulk packaging.

**I**

**Voltage Rating**

- A: FT, 50 VDC
- C: FT, 100 VDC
- E: FT, 200 VDC
- G: Pi, 50 VDC
- H: Pi, 100 VDC
- I: Pi, 200 VDC

**81**

**Outer Diameter**

Example:  
0.081" = 81

**50**

**Inner Diameter**

Example:  
0.050" = 50

**173**

**Length**

Example:  
0.173" = 173

**X7R**

**Ceramic Code**

- NP0
- X7R
- Y5V

**471**

**EIA Cap Code**

Example:  
470 pF = 471

**M**

**EIA Cap Tolerance**

- M: ±20%
- N: ±30%
- P: +100 -0%
- Z: +80 -20%

## Typical Insertion Loss - Pi Capacitors

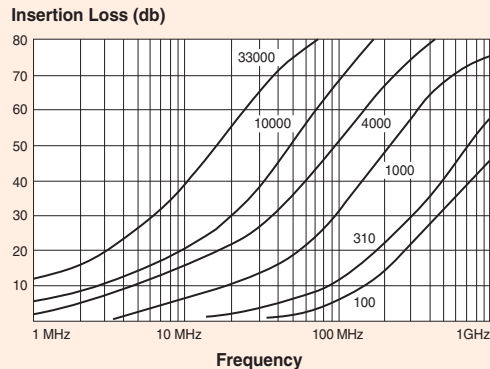

## Pi Construction

### Solid

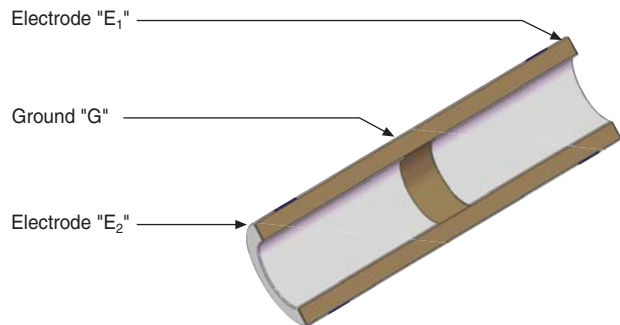

### MultiLayered Tube

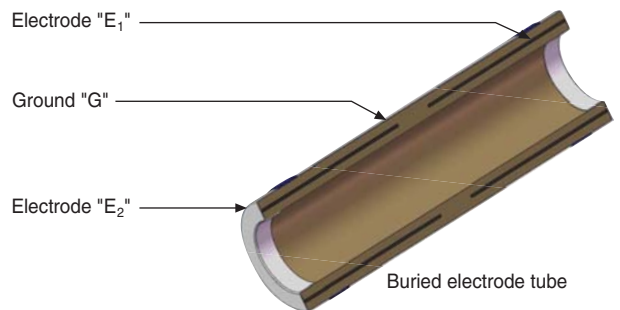

# Mil Qualified & DSCC Certified SMPS Capacitor Assemblies



Ceramic Capacitors

API Technologies' Spectrum Control line of MIL-PRF-49470 qualified and DSCC 87106 certified Switch Mode Power Supply capacitors are designed to provide superior performance in high frequency switching applications. These capacitors are ideal for high energy density products found in both military and commercial markets.

- Capacitance values 0.01µF to 47µF
- Leaded parts safeguard against thermal and mechanical stresses

API's High-speed SMPS capacitors have the following characteristics when compared to other capacitive elements:

- Lower Equivalent Series Resistance (ESR)
- Lower Equivalent Series Inductance (ESL)
- Lower ripple voltage and less self heating

## Dielectric Characteristics

API offers SMPS capacitors in two basic dielectric classes, with individual designs tailored to meet specific performance characteristics.

Dielectric Type	Stability Class	Description
BP (NPO/COG)	Ultra Stable Class I	Effects on electrical properties are minimal with variations in operating temperature, voltage, frequency or time. Used in applications which require stable performance.
BQ, BR and BX	Stable Class II	Class II dielectrics will exhibit a predictable shift in performance characteristics when exposed to variations in temperature, voltage, frequency or time. Selected for applications where blocking, coupling, by-passing and frequency discriminating elements are used. Offers higher capacitance than Class I (COG).

Style/Size	Dimensions					Leads/Side
	A max	B max	C ±0.025"	D ±0.025"	E max	
SMP-3 (in) (mm)	0.650 16.50	0.715 18.16	0.450 11.42	1.050 26.65	0.500 12.69	10
SMP-4 (in) (mm)	0.650 16.50	0.715 18.16	0.400 10.15	0.400 10.15	0.440 11.17	4
SMP-5 (in) (mm)	0.650 16.50	0.715 18.16	0.250 6.35	0.250 6.35	0.300 7.62	3

N Lead Configuration

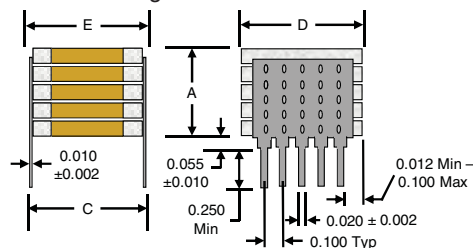

L Lead Configuration

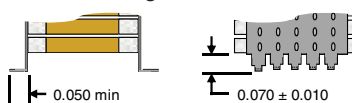

J Lead Configuration

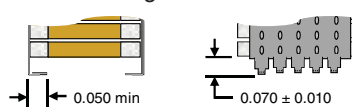

6/M Surface Mount Configuration



## SMPS Part Numbering System

**Example: SMP3X124KENMB00**

The part number shown represents a size 3 SMPS capacitor. The ceramic type will be BX, capacitance value is 120,000 pF, with a tolerance of ±10%. The voltage rating is 500 VDC, termination will be "N" style leads and the parts will receive marking/ bulk packaging.

SMP3	X	124	K	E	N	M	B	00
<b>Case Size</b>	<b>Ceramic Code</b>	<b>EIA Cap Code</b>	<b>EIA Cap Tolerance</b>	<b>Voltage Rating</b>	<b>Termination</b>	<b>Marking</b>	<b>Packaging</b>	<b>Special Requirements</b>
SMP3 SMP4 SMP5	P: BP Q: BQ R: BR X: BX	Example: 120,000 pF	J: ±5% K: ±10% M: ±20%	Z: 25 VDC A: 50 VDC B: 100 VDC C: 200 VDC E: 500 VDC	J: Leads in L: Leads out N: Leads straight	M: Marked U: Unmarked	T: Tape & Reel F: Foam carrier/boxed W: Waffle B: Bulk	GA:87106 Group A HR:Hi-Rel*

\* HR: Hi-Rel designation reflects MIL-PRF-49470, level B, QPL approval



# Military/Hi-Rel & Commercial/Industrial Grade SMPS Capacitor Assemblies

API Technologies' Spectrum Control brand offers high reliability/military grade and commercial/industrial grade capacitors designed to provide superior performance in high frequency switch mode power supply applications. These capacitors are ideal for bulk capacitance and pulsing applications and are available in a range of different footprints and mounting configurations. The high reliability/military grade is based on the design principals and test requirements defined by MIL-PRF-49470.

- Leaded options safeguard against thermal and mechanical stresses in larger package sizes
- Capacitance values 0.01  $\mu$ F to 150  $\mu$ F
- Stable Class II, BX, BR, BQ and X7R dielectric materials offer reliable operation and predictable performance characteristics related to temperature, frequency and voltage

API's line of Spectrum Control high-speed Switch Mode Power Supply capacitors have the following characteristics when compared to other capacitor technologies:

- Lower Equivalent Series Resistance (ESR)
- Lower Equivalent Series Inductance (ESL)
- Lower ripple voltage and less self heating

## Electrical Characteristics

VTC	WVDC	Maximum Capacitance Value									
		2225	2425	3530	3640	3940	4540	5550	6560	7565	44105
X7R	50	156	156	276	396	476	566	826	127	157	157
X7R	100	685	685	126	186	206	256	396	566	686	586
X7R	200	475	475	685	825	106	126	156	256	336	276
X7R	500	155	155	275	395	395	475	685	825	126	126
BX	50	475	565	106	126	156	185	276	396	576	476
BX	100	215	335	475	575	825	825	125	186	226	276
BR	200	125	155	255	395	395	475	685	106	126	126
BQ	500	564	684	125	155	185	185	275	475	565	565

## Dimensions (Refer to drawings on page 14)

Dimensions in (mm)	Case Size									
	2225	2425	3530	3640	3940	4540	5550	6560	7565	44A5
C $\pm 0.025$ (0.635)	0.235 (5.97)	0.250 (6.35)	0.360 (9.14)	0.370 (9.40)	0.400 (10.16)	0.460 (11.68)	0.560 (14.22)	0.660 (16.76)	0.760 (19.30)	0.450 (11.42)
D Min - Max	0.224-0.275 (5.69-6.99)	0.224-0.275 (5.69-6.99)	0.275-0.325 (6.99-8.26)	0.350-0.425 (8.89-10.80)	0.350-0.425 (8.89-10.80)	0.350-0.425 (8.89-10.80)	0.450-5.25 (11.43-13.34)	0.550-0.625 (13.97-15.88)	0.600-0.675 (15.24-17.15)	0.950-1.075 (24.13-27.31)
E Max	0.300 (7.62)	0.300 (7.62)	0.420 (4.67)	0.430 (10.92)	0.440 (11.17)	0.530 (13.46)	0.630 (16.00)	0.730 (18.54)	0.830 (21.08)	0.500 (12.70)
A Max	0.650 (16.51)	0.650 (16.51)	0.650 (16.51)	0.650 (16.51)	0.650 (16.51)	0.650 (16.51)	0.650 (16.51)	0.650 (16.51)	0.650 (16.51)	0.650 (16.51)
# Leads/Side	3	3	3	4	4	4	5	6	6	10

Note: C dimension for non-leaded chip capacitors equals dimension specified less the thickness of the leads or 0.020" total

## SMPS Part Numbering System

Example: **2225X824KAJMBHR**

The part number shown represents a 2225 size SMPS capacitor. The ceramic type is X7R / BX, capacitance value is 0.82  $\mu$ F, with a tolerance of  $\pm 10\%$ . The voltage rating is 50 VDC, termination is "J" style leads, Group A testing is M49470 Group A, Subgroups 1 & 2 and the parts will receive marking / bulk packaging.

2225	X	824	K	A	J	M	B	HR
Case Size Ref Dimensions Table	Ceramic Code	EIA Cap Code	EIA Cap Tolerance	Working Voltage	Lead Configurations	Marking	Packaging	Special Requirements*
A: 1.0 B: 1.1 C: 1.2 D: 1.3 E: 1.4 F: 1.5	B: X7R Q: BQ R: BR X: BX	824= 820,000 pF= 0.82 $\mu$ F 125= 1,200,000 pF= 1.2 $\mu$ F 156= 15,000,000 pF= 15 $\mu$ F	K: $\pm 10\%$ M: $\pm 20\%$	A: 50 VDC B: 100 VDC C: 200 VDC E: 500 VDC	J: Leads in L: Leads out N: Leads straight 6: Ag termination M: PdAg termination	M: Marked U: Unmarked (Std)	B: Bulk F: Foam carrier/boxed S: Special T: Tape & Reel - 7 in W: Waffle	00: Standard HR: M49470 XX: Custom

For dimensions  $\geq 1.000"$   
Substitute letters above eg.

44A5 = 44105 chip size

\* 00 Designation reflects sample visual / mechanical inspection, plus 100% Capacitance, DF, DWV & IR testing @ +25°C  
HR designation reflects Group A, Subgroups 1 & 2 inspection per MIL-PRF-49470

Additional package sizes, capacitance values and higher voltage ratings available, please contact factory.

For complete specs and drawings, visit [eis.apitech.com/smps](http://eis.apitech.com/smps)

# Planar Capacitors

Ceramic Capacitors

API Technologies' Spectrum Control brand designs and manufactures a wide range of planar capacitor arrays. Using over 25 years expertise in multilayer ceramic capacitor manufacturing, planar capacitors offer many advantages over stand-alone chip, discoidal or tubular capacitors: low profile, compact, quick assembly time. Various custom and industry standard geometries are available and our designs can incorporate multiple capacitance values, feed-through holes and ground holes. With a combination of versatility and function, API's planar capacitors are quickly becoming the new standard in filtered connectors used in EMI suppression applications.

## Features

- Unparalleled electrical performance and reliability
- Fast prototyping and short lead times
- 100% electrical and dimensional testing of critical parameters
- Custom packaging to suit end user needs
- Custom and standard designs available
- Multiple capacitance values up to 400:1 ratio
- Multiple voltage ratings available
- Hole ground resistance to a specified maximum
- Conformal coat available for high voltage designs

## Mechanical Specifications

- Dielectrics:* ..... EIA Codes: NP0 (COG), X7R, Z5U
- Termination:* ..... Nickel barrier/Gold or Fired-on silver, Palladium silver or Platinum silver
- Surface:* ..... Lapped, termination bandwidth and insulative coating options
- Geometry:* ..... Military circulars, D-Sub, ARINC, Micro-D, custom configurations
- Thickness:* ..... Up to 0.150"
- Camber:* ..... Within  $\pm 0.004$ " per inch



## Electrical Specifications

- Operating Temperature* ..... -55°C - 125°C
- Capacitance* ..... Up to 1 $\mu$ F
- Capacitance Tolerance* .....  $\pm 10\%$ ,  $\pm 20\%$ ,  $+100\%$
- Voltage Rating* ..... Up to 1500VDC  
 ..... AC Rating available – contact factory
- Dielectric Withstanding Voltage* ..... Up to 3000VDC
- Insertion Loss* ..... 60 dB Min, typical hole to hole

The electrical properties listed above are typical, and can be exceeded based on customer requirements and mechanical configuration. Since many variables affect the design, it is best to contact us directly for a detailed assessment of your planar capacitor needs.

## Typical Design Layouts

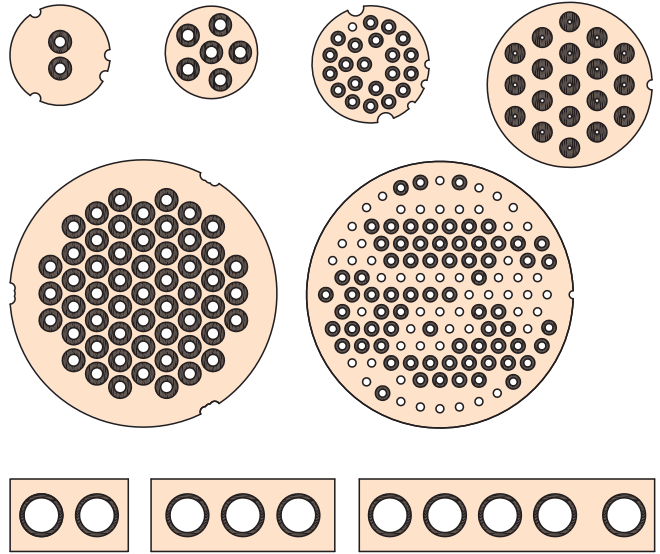



# Surface Mount EMI Filters

*our family of surface mount filters is designed to provide a range of high performance EMI filtering options with a minimal PCB footprint*

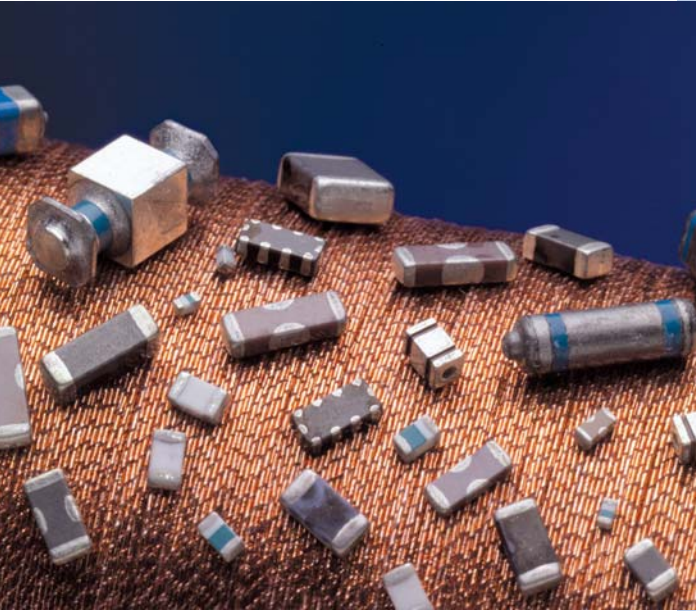

**Three Terminal Chips** offer superior ability to withstand transient voltages and surges, and deliver excellent filtering performance in high current applications while providing exceptional solderability and resistance to solder heat... **18**

**SA Series Arrays** incorporate four lines in one compact footprint. These arrays are nonpolar and designed to minimize residual inductance, thereby ensuring large insertion loss in a wide band and better cross talk control... **19**

**MSM Mini-Surface Mount** offers a multilayer electrode structure, high temperature construction and 10 Amps current ratings. The filter chips provide extreme elimination of residual inductance and the self-resonant frequency extends to the microwave band... **20**

**SSM Square Surface Mount** square mechanical geometry enhances SMT soldering in applications up to 10 Amps. These filters come in a Pi circuit configuration and are designed to address EMI/RFI on crowded printed circuit boards... **20-21**

**PSM Power Surface Mount** are the first high temperature surface mount filter designed to effectively filter EMI/RFI at currents up to 20 Amps. These filters come in either a Feed-through or Pi circuit configuration and offer superior high frequency noise suppression... **21**

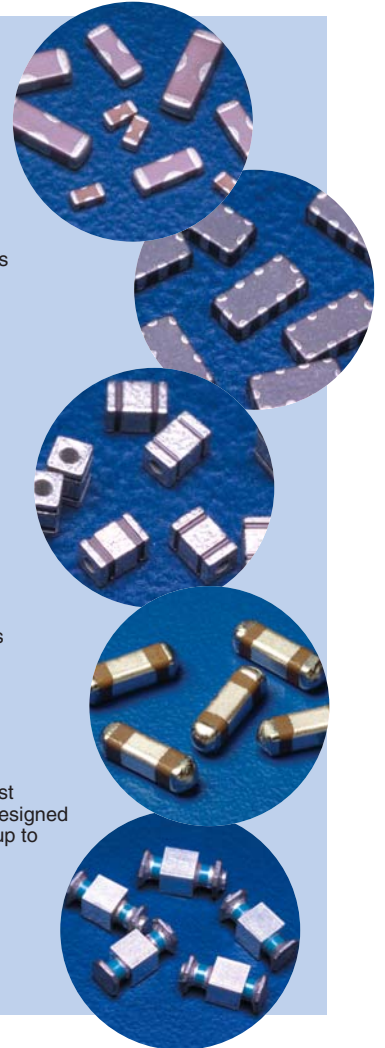

## Advantages of a Surface Mount Filter

With many years of experience in the design and manufacture of filters, API Technologies has a unique perspective on EMI and how to control it. We provide an integrated approach to EMC problems with services such as customer consulting, diagnostic testing, design and manufacturing. By offering a variety of custom assemblies, we are able to unite your specific requirements with our high performance filters.

API's Spectrum Control line of surface mount EMI filters are ideal for a wide range of PCB applications, including: automotive electronics, digital A/V equipment, computers, peripherals, telecommunications, switching power supplies and high current buss lines.

# Three Terminal Chips

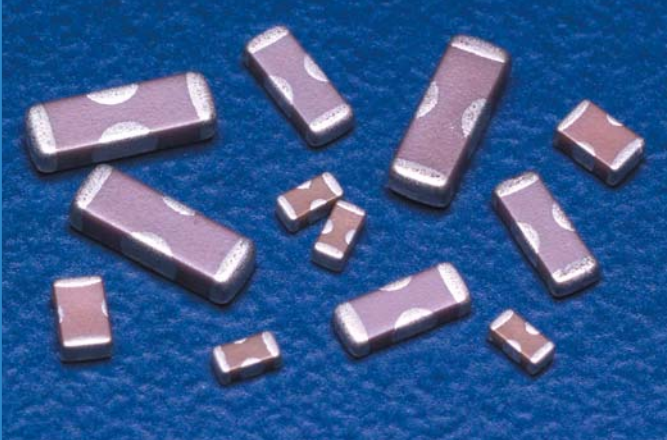

## Features

- Excellent performance in high current applications
- Nonpolar, surface mountable
- Superior filtering characteristics
- Superb ability to withstand transient voltages and surge
- Offers exceptional solderability and resistance to solder heat
- Available in 0603, 0805, 1205 and 1806 body size
- Two amp current rating available
- Available lead free/RoHS compliant

## Applications

- Cellular telephones and base stations
- Telecommunication equipment
- Industrial electronic interface or programmable controllers
- Electronic automotive equipment
- Computer and peripheral equipment

## Electrical Characteristics

*Capacitance Range* . . . . . COG (NPO) 22 pF to 470 pF  
 X7R 470 pF to 47,000 pF  
 Y5V 100,000 pF and 220,000 pF

*Capacitance Tolerance* . . . . . COG (NPO) +50/-20%  
 X7R +50/-20%  
 Y5V +80/-20%

*Temperature Coefficient* . . . . . COG (NPO) 0 ±30 ppm/°C,  
 -55 to +125°C  
 X7R +/-15%,  
 -55 to +125°C  
 Y5V +30/-80%,  
 -25 to +85°C

*Insulation Resistance* . . . . . up to 22,000 pF 10,000 MΩ  
 @ +25°C 47,000 pF 5000 MΩ  
 100,000 pF 1000 MΩ

*DC Resistance* . . . . . 0.4 Amp or less 0.3 Ω max.  
 1 Amp 0.08 Ω max.  
 2 Amp 0.04 Ω max.

*Rated Voltage* . . . . . up to 100 VDC

*Rated Current* . . . . . up to 2 Amps

## Ordering Information

*Example: SF0805C221SBNCT*

This part number represents a three terminal chip with a body size of 0805 with a COG (NPO) dielectric. The capacitance is 220 pF with a capacitance tolerance of +50%/-20%. Voltage rating is 50 Volts DC. It has nickel barrier, solder plated terminations and a current rating of 0.4 Amp, (400 milliamps). The parts are taped and reeled.

## Circuit Schematic

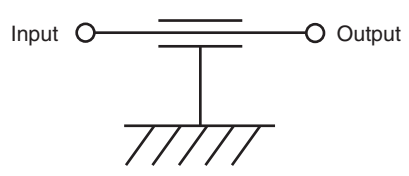

SF	0805	C	221	S	B	N	C	T
Style	Size	Ceramic	Capacitance Code	Capacitance Tolerance	Rated Voltage (Vdc)	Termination	Current Rating	Packaging
SF	0603 0805 1205 1806	C - COG X - X7R Y - Y5V	First two numbers are significant, the third number refers to number of zeroes	S - +50%/-20% Z - +80%/-20%	A - 25 B - 50 D - 100	N - Ni Barrier, Solder Plated	B - 0.3 A C - 0.4 A D - 1 A E - 2 A F - 3 A G - 4 A H - 5 A I - 6 A	T - Tape & Reel B - Bulk

Surface Mount EMI Filters



# SA Series Arrays

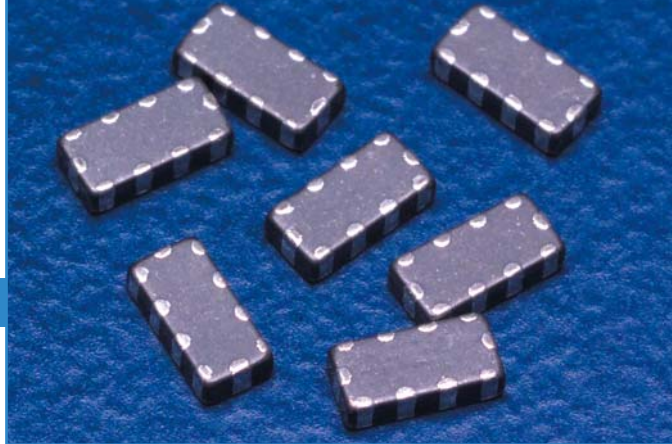

## Features

- The filter's structure minimizes residual inductance with a high self-resonant frequency, ensuring large insertion loss in a wide band.
- The common ground electrode built into the chip ensures complete grounding of all lines at the ground on both ends. The filter is designed to minimize cross talk.
- An optimum constant can be selected from the capacity range of 22-22,000 pF to best suit the frequency.
- Solder plated nickel barrier terminations offer good solderability and resistance to soldering heat.
- Available lead free/RoHs compliant

## Applications

- Noise reduction for DC lines on computers
- Computer peripheral equipment
- Audio visual equipment
- Cellular telephones and base stations
- Telecommunications equipment
- Power amplifiers and supplies

## Ordering Information

Example: **SA1206C220MBNB**

The part number represents a 4-capacitor array with a body size of 1206 with a COG (NPO) dielectric. The capacitance is 22 pF with a capacitance tolerance of ±20%. Voltage rating is 50 VDC. It has nickel barrier, solder plated terminations, and the parts are bulk-packaged.

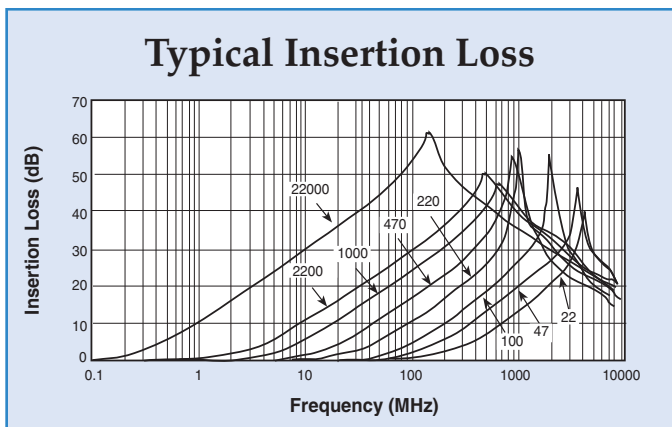

## Electrical Characteristics

- Rated Voltage . . . . . 25 VDC to 50 VDC
- Rated Current . . . . . 0.3 Amps
- IR . . . . . 10,000 MΩ Min.
- DC Resistance . . . . . 0.3 Ω Max.
- Temperature Range . . . . . -55°C to +125°C
- Capacitance Range . . . . . 22 pF to 22,000 pF
- Capacitance Tolerance . . . . . ±20%

## Circuit Schematic

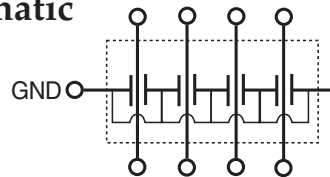

SA	1206	C	220	M	B	N	B
Style	Size	Temperature Characteristics	Capacitance	Capacitance tolerance	Rated Voltage (Vdc)	Termination	Packaging
SA Series	1206	C +/- 30 ppm/°C R +/- 15% U -750 +/- 120 ppm/°C	22 pF 47 pF 100 pF 220 pF 470 pF 1,000 pF 2,200 pF 22,000 pF	M = ± 20%	A = 25 B = 50	N = Ni Barrier Solder Plated	T - Tape and reel 4,000 pc/reel B - Bulk pack 1,000 pcs/bag

# MSM, SSM & PSM Series Filters

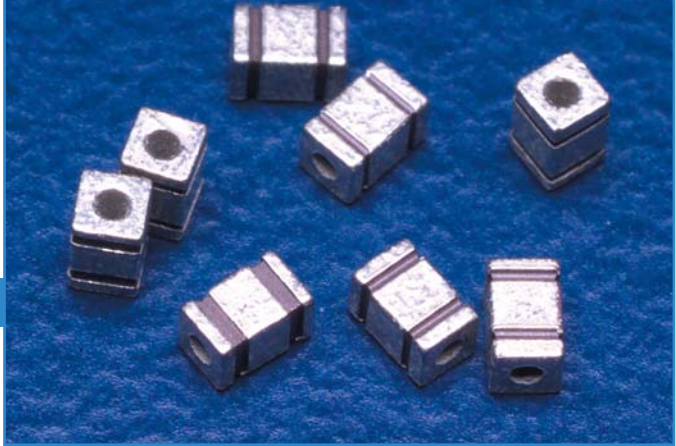

## MSM - Miniature Surface Mount Chip Capacitors

The MSM series filters feature high temperature construction and have current ratings up to 10 Amps. The filter chips exhibit very low levels of residual inductance and the self-resonant frequency extends to the microwave band. Applications include telecommunication equipment, computer and peripheral equipment and digital AV equipment, medical equipment, and DC power supply lines.

### Features

- Miniature footprint helps in dense circuit configuration
- Rated at 10 Amps
- Packaged in tape and reel or bulk form
- Operating temperature ranges of -25°C to +85°C and -55°C to +125°C
- Available lead free/RoHs compliant

## Electrical Characteristics

- Working Voltage* . . . . . 50 VDC
- Test Voltage* . . . . . 150 VDC
- Current Rating* . . . . . 10 Amps max.
- Insulation Resistance* . . . . . 1.0 MΩ
- Terminations* . . . . . Ni-Barrier, solderable finish
- Soldering Conditions* . . . . . Max. 250°C -5 sec.

## MSM Ordering Information

<b>MSM</b>	<b>4</b>	<b>T</b>	<b>470M</b>	<b>10</b>	<b>T</b>															
Style	Circuit Configuration	Temperature Characteristics	Capacitance	Current Rating	Packaging															
MSM (Miniature)	4 - Feed-Through	R - +/-15% T - +22/-33% V - +22/-82%	<table border="1" style="width: 100%; border-collapse: collapse; text-align: center;"> <thead> <tr> <th>Code</th> <th>Value</th> <th>Tolerance</th> </tr> </thead> <tbody> <tr> <td>470 M</td> <td>47 pF</td> <td>+50/- 20%</td> </tr> <tr> <td>151 M</td> <td>150 pF</td> <td>+50/- 20%</td> </tr> <tr> <td>271 M</td> <td>270 pF</td> <td>+50/- 20%</td> </tr> <tr> <td>102 M</td> <td>1000 pF</td> <td>+50/- 20%</td> </tr> </tbody> </table>	Code	Value	Tolerance	470 M	47 pF	+50/- 20%	151 M	150 pF	+50/- 20%	271 M	270 pF	+50/- 20%	102 M	1000 pF	+50/- 20%	10 Amps	T - Tape and Reel 2,000 pcs/reel B - Bulk pack 1,000pcs/reel
Code	Value	Tolerance																		
470 M	47 pF	+50/- 20%																		
151 M	150 pF	+50/- 20%																		
271 M	270 pF	+50/- 20%																		
102 M	1000 pF	+50/- 20%																		

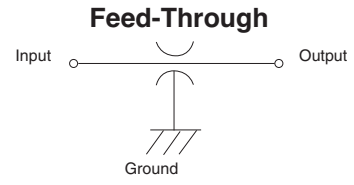

## SSM - Square Surface Mount Filters

The SSM series filters feature high temperature construction and have current ratings up to 10 Amps. The filter chip series are nonpolar and surface mountable with excellent performance characteristics and come in a Pi circuit configuration. Applications include telecommunication equipment, computer and peripheral equipment, digital AV equipment, power amplifiers, power supplies and high current buss lines.

### Features

- Square mechanical geometry enhances SMT soldering
- Rated to 10 Amps
- Packaged in tape and reel or bulk form
- Operating temperature range of -55°C to +125°C
- Available lead free/RoHs compliant



Surface Mount EMI Filters



# MSM, SSM & PSM Series Filters

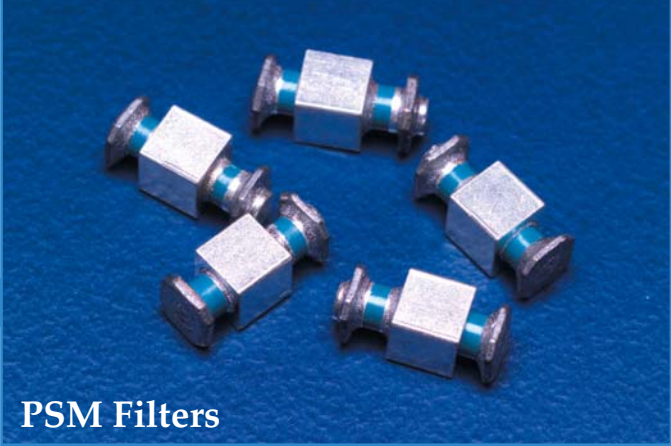

**PSM Filters**

## SSM Electrical Characteristics

- Working Voltage . . . . . 100 VDC
- Test Voltage. . . . . 250 VDC
- Current . . . . . Max. 10 Amps
- Insulation Resistance . . . . . Min. 10<sup>4</sup> MΩ
- Terminations . . . . . Silver plated
- Soldering Conditions . . . . . Max. 250°C -5 sec.
- Marking. . . . . None

## PSM - Power Surface Mount Filters

The PSM series filters feature high temperature construction and have current ratings up to 20 Amps. This filter series is nonpolar and surface mountable with excellent performance characteristics and comes in either a Feed-through or Pi circuit configuration. Applications include telecommunication equipment, computer and peripheral equipment, digital AV equipment, power amplifiers, power supplies and high current buss lines.

### Features

- Provides time and costs savings compared to through-hole filters
- Superior high frequency filtering capability
- Rated to 20 Amps
- Packaged in tape and reel or bulk form
- Operating temperature range of -55°C to +125°C
- Available lead free/RoHs compliant

### Ordering Information

**Example: PSM4-402Z-20T0**

The part number shown represents a power surface mount feed-through filter with a capacitance value of 4000 pF and capacitance tolerance of +80/-20%. The current rating of the part is 20 Amps and the packaging is tape and reel.

<b>PSM</b>	<b>4</b>	-	<b>402Z</b>	-	<b>20</b>	<b>T</b>	<b>0</b>	
Style						Packaging	Tape and Reel	
PSM (Power) SSM (Square)	<b>PSM Capacitance</b>			<b>SSM Capacitance</b>			T - Tape and reel packaging B - Bulk packaging	0 - 500 pieces 1 - 1,000 pieces 2 - 2,000 pieces 6 - 6,000 pieces
	Code	Value	Tolerance	Code	Value	Tolerance		
Circuit Configuration	680M	68 pF	±20%	101Z	100 pF	+80/-20%	<b>Current Rating</b> 05 - 5 Amps 10 - 10 Amps (Pi) 20 - 20 Amps (Feed-Through)	Note: Tape and reel packaging - 500 & 1,000 pieces (7") and 2,000 & 6,000 pieces (13")
	1 - Pi	101M	100 pF	±20%	501P	500 pF		
4 - Feed-Through	131P	130 pF	+100/-0%	152P	1500 pF	+100/-0%		
	471P	470 pF	+100/-0%	202P	2000 pF	+100/-0%		
	821M	820 pF	±20%	402E	4000 pF	±25		
	102M	1000 pF	±20%	402Z	4000 pF	+80/-20%		
	152M	1500 pF	±20%					
	252P	2500 pF	+100/-0%					
	402Z	4000 pF	+80/20%					
	103Z*	.01 μF	+80/-20%					
			* Available in Feed-Through circuit only.					

## SSM Pi Circuit

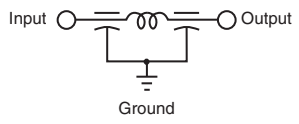

## PSM Electrical Characteristics

- Voltage Rating DC . . . . . 200 VDC @ -55°C to +125°C
- DWV . . . . . 700 VDC
- Current Rating . . . . . 20 Amps (Feed-through) max.  
10 Amps (Pi) max.
- Insulation Resistance . . . . . 1.0 GΩ @ 25°C
- Dissipation Factor . . . . . 4.0% maximum
- D.C.R. . . . . Max. .0005Ω, typ. .0002Ω
- Terminations . . . . . Solderable finish

## PSM Feed-Through & Pi Circuits

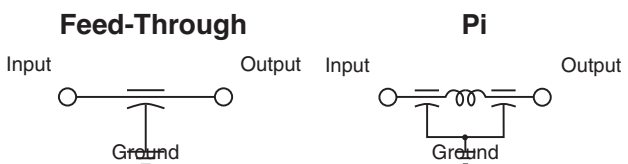

Surface Mount EMI Filters

# Low Pass EMI Filters

*the industry's most complete line of EMI filters gives you more style, size, IL performance and cost alternatives*



## Low Pass EMI Advantages

API Technologies' Spectrum Control brand was founded in 1968 as a designer and manufacturer of Electromagnetic Interference (EMI) filters. These many years of experience have yielded an engineering-driven team that understands how and where potential EMI problems exist in an electronic system and how to best eliminate them. With an extensive library of standard products and a willingness to develop an application-specific custom solution, our customers count on us to help them satisfy global EMC standards while meeting demanding design parameters.

**Solder-In Filters** offer an ideal solution for applications in critical areas where space does not allow for use of mounting tools or hardware. Available in C, Pi and standard L circuit configurations and primarily used in filtering signal/data lines and AC power lines... 24

**9925 Series Filters** have a knurled design allowing them to be pressed into place creating a reliable mechanical bond making them an excellent choice for applications where soldering is undesirable... 25

**Spec Spin Filters** are an excellent choice for applications that require many lines to be filtered in close proximity to each other due to their space saving #2-56 threaded miniature EMI spanner design. These filters are designed without a hex and do not require soldering for installation... 25

**Resin Sealed Filters** provide excellent environmental protection in a rugged case that is resin sealed at both ends and easily mounted with a tapped hole or through hole. These filters are provided in C, L and Pi configurations with metric threading available... 26

**High Current Resin Sealed Filters** are ideal for use in high current 5 volt logic buss, as well as  $\pm 48$  VDC telephone rack buss, high current switch mode power supplies and DC charging systems. These filters feature rugged bolt-in style for easy installation... 27

**Hermetically Sealed Filters** feature hermetic glass seals and high EMI filtering performance making them highly reliable in the toughest environmental conditions. These filters are available with C, L, Pi, T and double T configurations with MIL-F-15733 and MIL-F-28861 QPL filters available... 28

**Value Added Assemblies** offer flexible solutions by allowing you to add connectors, modify terminations or add wire harnesses, thereby lowering your cost of acquisition and assembly, reducing your production time/costs and inventory, all while giving you a filter assembly that meets your unique design challenges... 29

- Wide range of package sizes, mounting options and circuit configurations offering maximum design flexibility
- Develop custom application-specific solutions addressing your mechanical and electrical requirements
- High reliability construction... built in accordance to MIL-PRF-15733 or MIL-PRF-28861
- Over 800 standard QPL products and DSCC part numbers
- Effective filtering up to 18 GHz
- Reliability testing available for customer specific requirements



# Solder-In Filters

Solder-in filters are ideal for use in critical areas where space does not allow use of mounting tools or hardware. The solder-in feature also allows installation in unison with other board mounted components. Primarily used in filtering signal/data lines and DC power lines.

## Features

- Small size to allow effective use of space
- Voltage ratings to 750 VDC
- Multiple circuit configurations: C, L and Pi available
- High temperature construction to prevent reflow during installation
- MIL-F-15733 QPL versions available

## Series 9900

### Miniature Solder-In Filters

These filters are ideal for microwave applications such as attenuators and oscillators, and perform well in high impedance circuits where large capacitance values are not practical.

## Features

- Miniature size to allow effective use of space
- Standard capacitance values from 5pF to .033µF
- Voltage ratings to 200 VDC/115 VAC 0 – 400 Hz
- Hermetically sealed on one end allows for through-hole sealing between compartments
- High temperature construction meets MIL-F-28861 solderability and resistance to soldering heat requirements
- Available in MIL-C-11015 versions
- Gold plating compatible with gold bonding techniques

\*\* Large Diameter High Temp Solder-In Filters are also available – please contact factory



## Electrical Specifications

### C Circuit

Capacitance . . . . . 100 pF to 0.30 µF

Voltage Rating . . . . . 50 to 750 VDC

Current Rating. . . . . 10 – 25 Amps

### Pi Circuit

Capacitance . . . . . 1500 pF to 0.022 µF

Voltage Rating . . . . . 50 to 500 VDC  
90 to 350 VAC

Current Rating. . . . . 10 – 25 Amps



## Electrical Specifications

### C Circuit

Capacitance . . . . . 10 pF to 0.030 µF

Voltage Rating . . . . . 50 to 200 VDC  
115 VAC

Current Rating. . . . . 5 Amps

### L Circuit

Capacitance . . . . . 5 pF to 0.033 µF

Voltage Rating . . . . . 50 to 200 VDC

Current Rating. . . . . 10 Amps

## Series 9925 Mini-Press Filters

This new knurled filter is designed to be pressed into place and creates a reliable mechanical bond. This feature makes it an excellent selection for applications where soldering is undesirable. Suitable plating is available that allows gold bonding to the terminals.

These filters are ideal for microwave and RF applications such as attenuators, synthesizers and oscillators. They perform well in high impedance circuits where large capacitance values are not practical.

### Electrical Specifications

Capacitance . . . . . 10 pF to 0.030  $\mu$ F

Voltage Rating . . . . . 50 to 200 VDC

Current Rating. . . . . 5 Amps

## Series 54-874-XXX Spec Spin Filters

API Technologies' Spectrum Control brand has developed a space saving #2-56 threaded miniature EMI spanner filter. This new threaded filter is designed without a hex and does not require soldering for installation. These features make it an excellent selection for applications that require many lines to be filtered in close proximity. The easy swap out also allows for flexibility in filter replacement and capacitance substitution. Easy filter substitution also allows for flexibility in filter placement. Custom design queries are always welcome.

API's Spectrum Control brand spanner filter offers superior insertion loss over a broad frequency range when compared to surface mount components. The filter is available in capacitance values up to 10,000 pF, and is featured in a microcircuit package used in microwave applications such as frequency synthesizers, power amplifiers, MMW radio, and is ideal for commercial and high-reliability applications.

### Electrical Specifications

Capacitance . . . . . 10 pF to 0.010  $\mu$ F

Voltage Rating . . . . . 50 VDC

Current Rating. . . . . 5 Amps



### Mechanical Specifications

Installation . . . . . Press-in

Plating . . . . . Gold

Seal . . . . . Glass sealed on one end,  
resin sealed on the other end

Termination Options. . . . . Plating suitable for gold bonding

Operating Temperature . . . -55°C to +125°C



### Mechanical Specifications

Center Spacing . . . . . 0.110"

Lead Finish . . . . . Gold

Bushing Finish . . . . . Gold

Tightening Torque. . . . . 16 oz-in ( $\pm$  2) (0.11 Nm)

### Insertion Tool



# Resin Sealed Bolt-In Filters

These filters are easily mounted in a tapped hole or through-hole with supplied nut and lock-washer. The rugged case with resin seals at both ends provides excellent environmental protection. Primarily used in filtering signal/data lines and DC power lines.

## Features

- MIL-PRF-15733 QPL filters available
- Metric threaded filters available, consult factory
- RoHS compliancy available

## Lead Options Available

- Straight
- Turret (nail head)
- Hooked
- Bends
- Flattened
- Flattened and notched
- Value added wires
- Many custom options

## Lead Finish

- Silver
- Tin/lead
- Gold - suitable for gold bonding



## Electrical Specifications

### C Circuit

Capacitance . . . . . 10 pF to 1.0  $\mu$ F  
 Voltage Rating . . . . . 50 to 500 VDC  
 115 VAC  
 Current Rating. . . . . 3 – 25 Amps

### L Circuit

Capacitance . . . . . 10 pF to 1.0  $\mu$ F  
 Voltage Rating . . . . . 50 to 500 VDC  
 115 VAC  
 Current Rating. . . . . 3 – 25 Amps

### Pi Circuit

Capacitance . . . . . 65 pF to 0.15  $\mu$ F  
 Voltage Rating . . . . . 50 to 700 VDC  
 350 VAC  
 Current Rating. . . . . 3 – 25 Amps

Low Pass EMI Filters

Thread Sizes	Circuits
4 - 40	C, L & Pi
6 - 32	C, L & Pi
6 - 40	Pi
8 - 32	C, L & Pi
10 - 32	C & Pi
12 - 28	C & Pi
12 - 32	C & Pi
5/16 - 24	C & Pi
5/16 - 32	C & Pi



# High Current/High Voltage Resin Sealed Filters



High current filters are ideal for use in high current 5 volt logic buss, but also can be used for  $\pm 48$  VDC telephone rack buss, high current switch mode power supplies and DC charging systems. High voltage filters find use in high voltage power supplies and applications requiring U.L. Hi-Pot.

## Features

- Current ratings up to 100 Amps
- Continuous voltage ratings up to 1250 VDC/ 240 VAC (400Hz)
- U.L. 1459 recognized and CSA C22.2 approved versions available
- Rugged bolt-in style for easy installation
- Available in C and Pi circuits

## Installation Notes

1. Mounting installation torque

**Method A:** Mounting in full threaded through hole

**Maximum torque:** 96 in-lbs

**Method B:** Mounting w/hardware

**Maximum torque:** 84 in-lbs

2. Terminal installation torque

**Maximum torque:** 20 in-lbs

Note: Use two-wrench method to install terminal hardware.

## Ordering Information

Part Number	Rated Voltage 125°C		I Amp	CKT	Min Cap	Minimum Insertion Loss (dB)							
	DC	AC***				1 MHz	3 MHz	10 MHz	30 MHz	100 MHz	300 MHz	1 GHz	10 GHz
54-848-005*	60	—	50	C	0.22 $\mu$ F	20	30	40	50	50	50	50	50
54-853-001*	60	—	50	C	0.22 $\mu$ F	20	30	40	50	50	50	50	50
54-853-004 €	200	140	100	C	0.22 $\mu$ F	20	30	40	50	50	50	50	50
54-848-008	200	140	100	C	0.22 $\mu$ F	20	30	40	50	50	50	50	50
54-844-001**	600	240	25	C	4700 pF $\pm$ 20%	—	—	12	20	30	33	50	50
54-844-002**	600	240	25	C	0.01 $\mu$ F $\pm$ 20%	3	7	20	25	35	40	57	57
54-763-008	750	—	25	C	1000 pF	—	—	—	10	20	28	28	28
54-763-009	750	—	25	C	4000 pF	—	—	10	22	32	35	35	40
54-789-003	1250	—	25	C	4000 pF	—	—	6	20	30	35	35	35
† 1280-060 €	2500	—	25	Pi	1500 pF	—	—	5	15	50	50	50	50

† Also available through API's authorized distributors.

€ Also available through API's authorized European distributors/agents.

\* Denotes parts that are UL recognized to UL 1459 and certified to CSA C22.2

\*\* Denotes parts that meet 1500 VAC Dielectric Withstanding Voltage per UL 1283 and CSA C22.2

\*\*\* AC Voltage to be 400Hz

# Hermetically Sealed Threaded Case Filters

This series of filters features hermetic glass seals and high EMI filtering performance. They are excellent for critical applications that demand high reliability in the toughest environmental conditions and provide broadband high performance EMI filtering from 1 KHz up to 10 GHz.

## Features

- MIL-PRF-15733 and MIL-PRF-28861, DSCC 84084 QPL filters available
- Popular .375", .410" and .690" case diameters
- Voltage ratings from 50 V to 400 VDC/240 AC, 400 Hz
- Impervious to high moisture environments, solvents and severe environmental conditions
- High temperature terminal construction
- D-slotted bushings
- High reliability testing available
- Metric threads available – consult factory

## Electrical Specifications

### C Circuit

Capacitance . . . . . 0.015  $\mu$ F to 4.0  $\mu$ F  
 Voltage Rating . . . . . 50 to 400 VDC  
 125 – 240 VAC  
 Current Rating. . . . . 10 – 25 Amps

### L Circuit

Capacitance . . . . . 0.015  $\mu$ F to 4.0  $\mu$ F  
 Voltage Rating . . . . . 50 to 400 VDC  
 125 to 240 VAC  
 Current Rating. . . . . 0.08 – 25 Amps

### Pi Circuit

Capacitance . . . . . 0.2  $\mu$ F to 5.2  $\mu$ F  
 Voltage Rating . . . . . 50 to 400 VDC  
 125 VAC, 240 VAC  
 0 – 60 Hz  
 Current Rating. . . . . 0.25 – 20 Amps

### Transient Suppression Pi

Capacitance . . . . . 1.4  $\mu$ F  
 Voltage Rating . . . . . 5 to 50 VDC  
 115 VAC, 240 VAC  
 Current Rating. . . . . 0.5 – 10 Amps



### T Circuit

Capacitance . . . . . 0.15  $\mu$ F to 1.4  $\mu$ F  
 Voltage Rating . . . . . 50 to 400 VDC  
 115 VAC, 240 VAC  
 Current Rating. . . . . 0.25 – 20 Amps

### TT Circuit

Capacitance . . . . . 0.5  $\mu$ F to 1.5  $\mu$ F  
 Voltage Rating . . . . . 50 to 300 VDC  
 125 VAC  
 Current Rating. . . . . 0.25 – 10 Amps

Low Pass EMI Filters

# Value-Added Low Pass Filter Assemblies

API Technologies' Spectrum Control line of value-added low pass filters provide flexible solutions to meet your unique design challenges. Our manufacturing process allows you to add connectors, modify terminations or add wire harnesses without adding much cost or drastically increasing lead times.

For custom requirements and exceptional needs, contact our design/manufacturing team.



Our value-added services:

- Allow you to stream-line your bill of materials.
- Reduce inventory/production costs.
- Offer custom application-specific low pass filter assemblies.

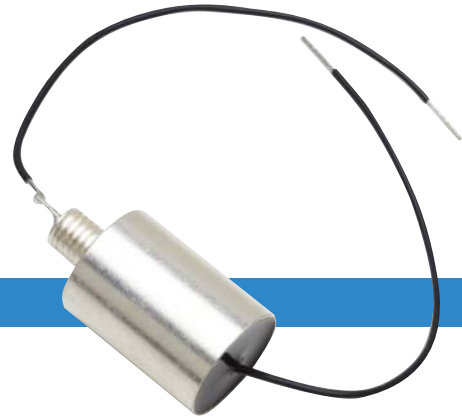

Incorporate specific terminations, connectors or wire harnesses to accommodate your application.



Lower the cost of acquisition and assembly.



Reduce production operations and lead times.



Build-to-order low pass filters.



# EMI Filtered Arrays

*our filter plates and terminal blocks provide exceptional EMI protection of signal and power lines at a lower total installed cost*



**Easy Mate® Filter Plates** reduce installation time and overall cost with its patented snap-in design to maximize real estate on PCBs. The Easy Mate® Jr. offers a lower profile for installation of feed-through filters into small hardware applications...32

**Bolt-In Filter Plates** provide EMI filtering for signal and power lines and an excellent method for electronic system interface. These plates eliminate the need to mount filters into bulkheads and are ideal for the isolation of electronic compartments to suppress EMI... 33

**Barrier Strip Filtered Terminal Blocks** are available in 2 to 6 terminal versions and our filter elements provide high insertion loss for EMI/RFI filtering of AC and DC power and control lines.

**Custom Filtered Arrays** help meet your design or manufacturing parameters through special mechanical and electrical specifications or by adding varying cable lengths and terminations for a complete turnkey assembly. Custom high reliability assemblies available...36



## Advantages of a Filtered Array

- Provide an EMI filtered signal or power line between electronic system modules
- Reduce cost . . . economical method to meet EMC requirements
- Reduce labor . . . eliminate need to assemble filters into a bulkhead
- Outperform surface mount EMI filters at frequencies above 50 MHz
- Reduce risk of damage to filter elements due to thermal shock and installation
- Improve reliability . . . every filter plate is 100% tested for key parameters
- Maximize real estate on PCB
- Mixed schematics in a single filter plate package

# Filter Plate Part Numbering System

Example: **52-898-206-BA2**

The part number shown represents an Easy Mate® filter plate with 2 rows, 6 filters per row. Filters are C style with a capacitance value of 100pF. The plate length is 1.092", and the leads are bent 90° to the right side.

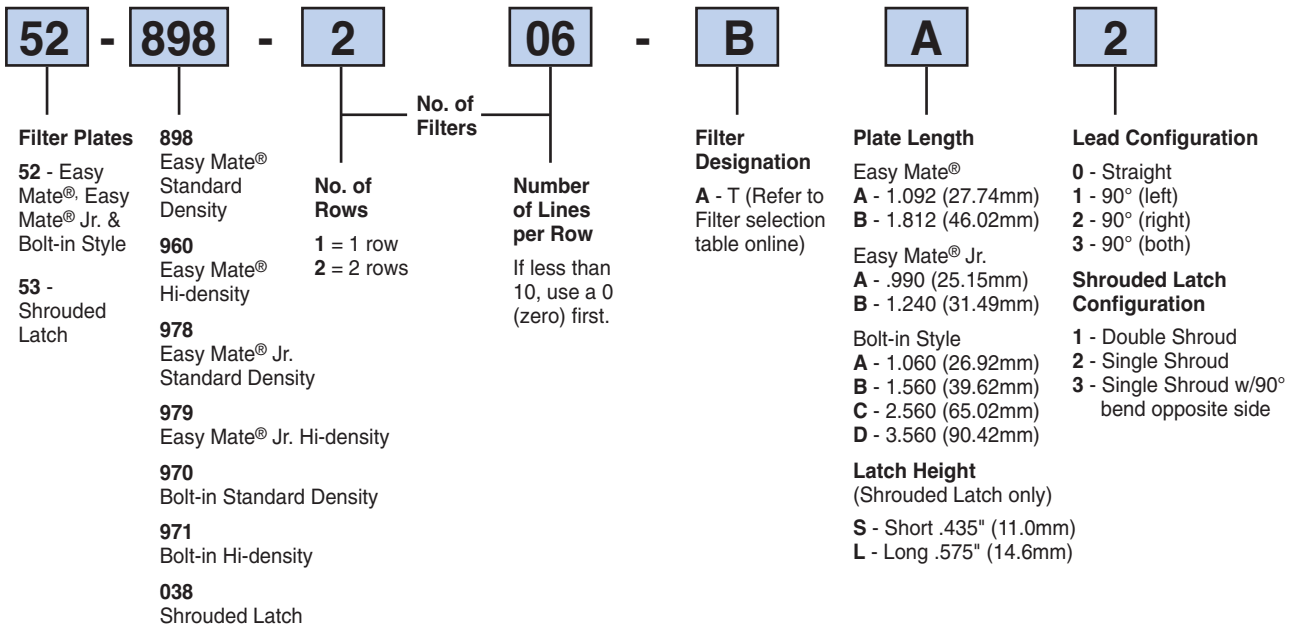

# Filtered Terminal Block Part Numbering System

Example: **52-160-006-A AOO**

The part number shown represents a barrier strip terminal block with six terminals and rated for 20 Amps. Male disconnects (.250") are the method of termination.

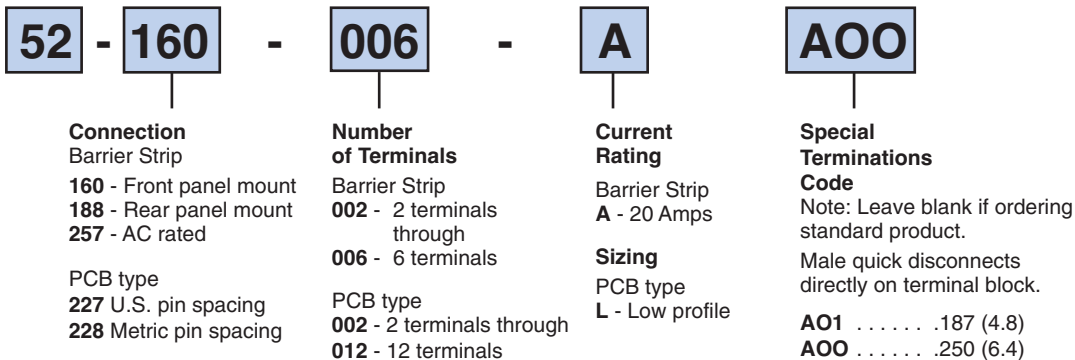

# Easy Mate® Filter Plates

API's Spectrum Control brand developed an EMI/RFI filter plate, Easy Mate®, which simplifies installation and eliminates the need for mounting hardware. The Easy Mate®, **patented**, is designed to "snap" into the chassis of electronic systems, reducing the labor required to complete a plate installation.

These plates are available in four lengths and in both standard density centers (.100") and high density centers (2mm). Standard density Easy Mate® plates offer up to 26 lines per plate in a double row configuration, while high-density plates offer up to 32 lines. Custom sizes for Easy Mate® plates are available.

## Easy Mate® Jr. Filter Plates

API has expanded its popular Easy Mate® family to include two more package sizes. These new sizes are lower profile and facilitate installation of feed-through filters into small hardware applications such as PCS linear power amplifiers and RF transmitters.

## Easy Mate Features

- Reduces installation time and overall cost
- Eliminates mounting hardware and prepwork
- Flexibility for 1 or 2 rows and standard density centers (.100") or high density centers (2mm)
- Improves overall quality and reliability
- Multiple dimpled finger ground contacts provides excellent long term EMI filtering from 5 MHz to 18 GHz
- Outperforms surface mount devices
- Maximize real estate on PCB
- Mixed capacitance values and schematics
- Ideal for isolation of electronic compartments
- Available in RoHS compliant versions

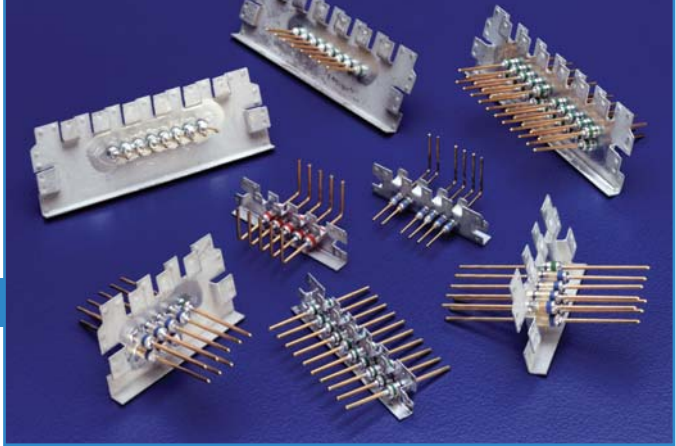

## Mechanical Specifications

<i>Base Plate Material</i> . . . . .	Beryllium copper
<i>Base Plate Thickness</i> . . . . .	.012 inches (0.30mm)
<i>Plating</i> . . . . .	Tin, RoHS version will be silver
<i>Lead Material</i> . . . . .	Copper alloy
<i>Lead Plating</i> . . . . .	Gold plate
<i>Lead Diameter</i> . . . . .	$\varnothing$ .025" (.64mm) for 0.100" centers (2.54mm) $\varnothing$ .020 (.51mm) for 0.079" centers (2.00mm)
<i>Current Rating</i> . . . . .	5 Amps for .025" $\varnothing$ (.64mm) 3 Amps for .020" $\varnothing$ (.51mm)
<i>Plate Lengths</i> . . . . .	Easy Mate® 1.092" (27.74mm) and 1.812" (46.02mm) Easy Mate® Jr. 0.990" (25.15mm) and 1.240" (31.49mm)

Filtered Arrays

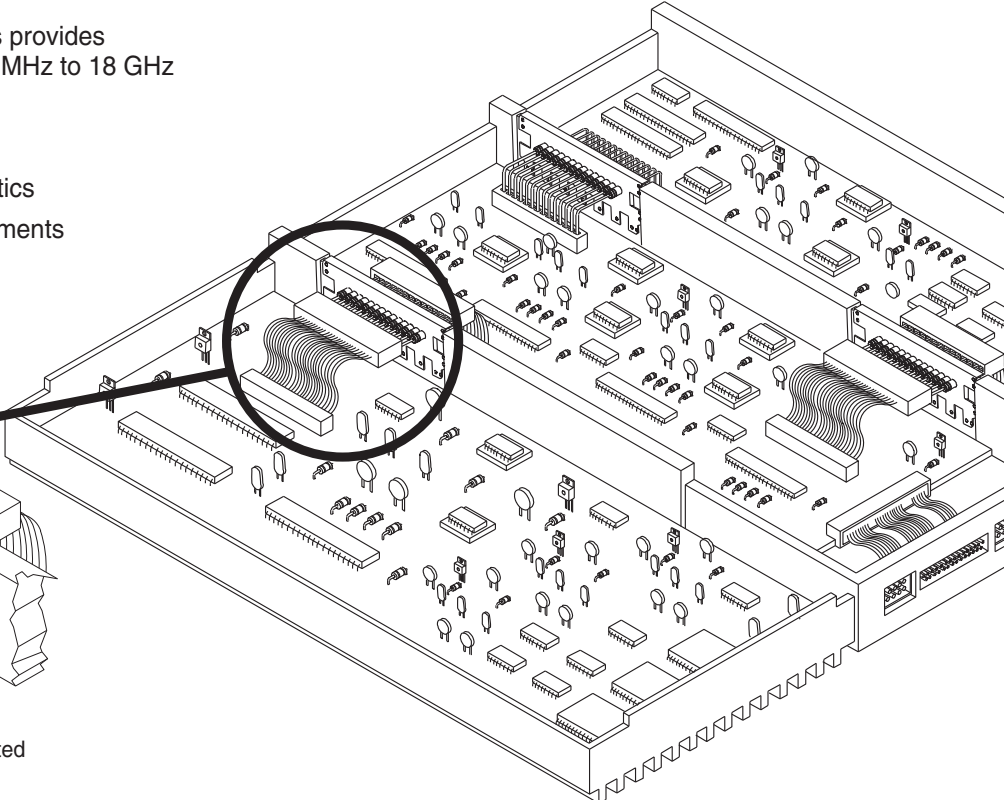
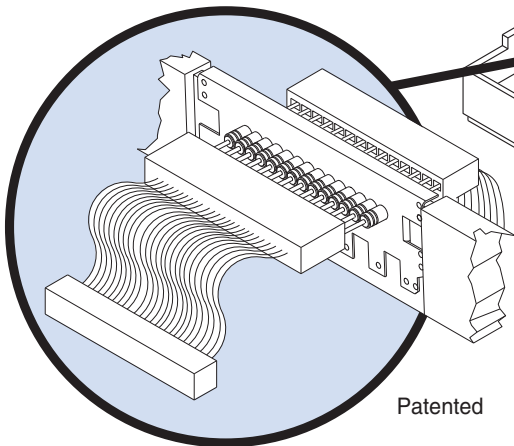



# Bolt-in Style Filter Plates

The Bolt-in style plate provides an excellent method for electronic system interface and EMI filtering. Bolt-in filter plates are available in a variety of plate sizes and up to 74 lines per plate in high density (2mm) and 60 pins per plate in standard density (.100"). On the larger plate sizes, API ensures structural integrity through a unique coining process.

## Features

- Eliminates the need to assemble filters into a bulkhead
- Excellent filtering from 5 MHz to 1 GHz
- Total cost savings vs. customer installed discrete filter elements
- Ideal for isolation of electronic compartments to suppress EMI
- Outperforms surface mount filters over 50 MHz
- Improved reliability
- Mixed capacitance values and schematics
- Maximize real estate on PCB
- Available in RoHS compliant versions
- Four standard plate lengths from 1.060" to 3.560"



## Mechanical Specifications

<i>Base Plate Material</i> . . . . .	Brass UNS C26000/C27000
<i>Base Plate Thickness</i> . . . . .	.020 inches (.51mm)
<i>Plating</i> . . . . .	Tin, RoHS version will be silver
<i>Lead Material</i> . . . . .	Copper alloy
<i>Lead Plating</i> . . . . .	Gold plate
<i>Lead Diameter</i> . . . . .	$\varnothing$ .025" (.64mm) for 0.100" centers (2.54mm) $\varnothing$ .020 (.51mm) for 0.079" centers (2.00mm)
<i>Current Rating</i> . . . . .	5 Amps for .025" (.64mm) $\varnothing$ 3 Amps for .020" (.51mm) $\varnothing$

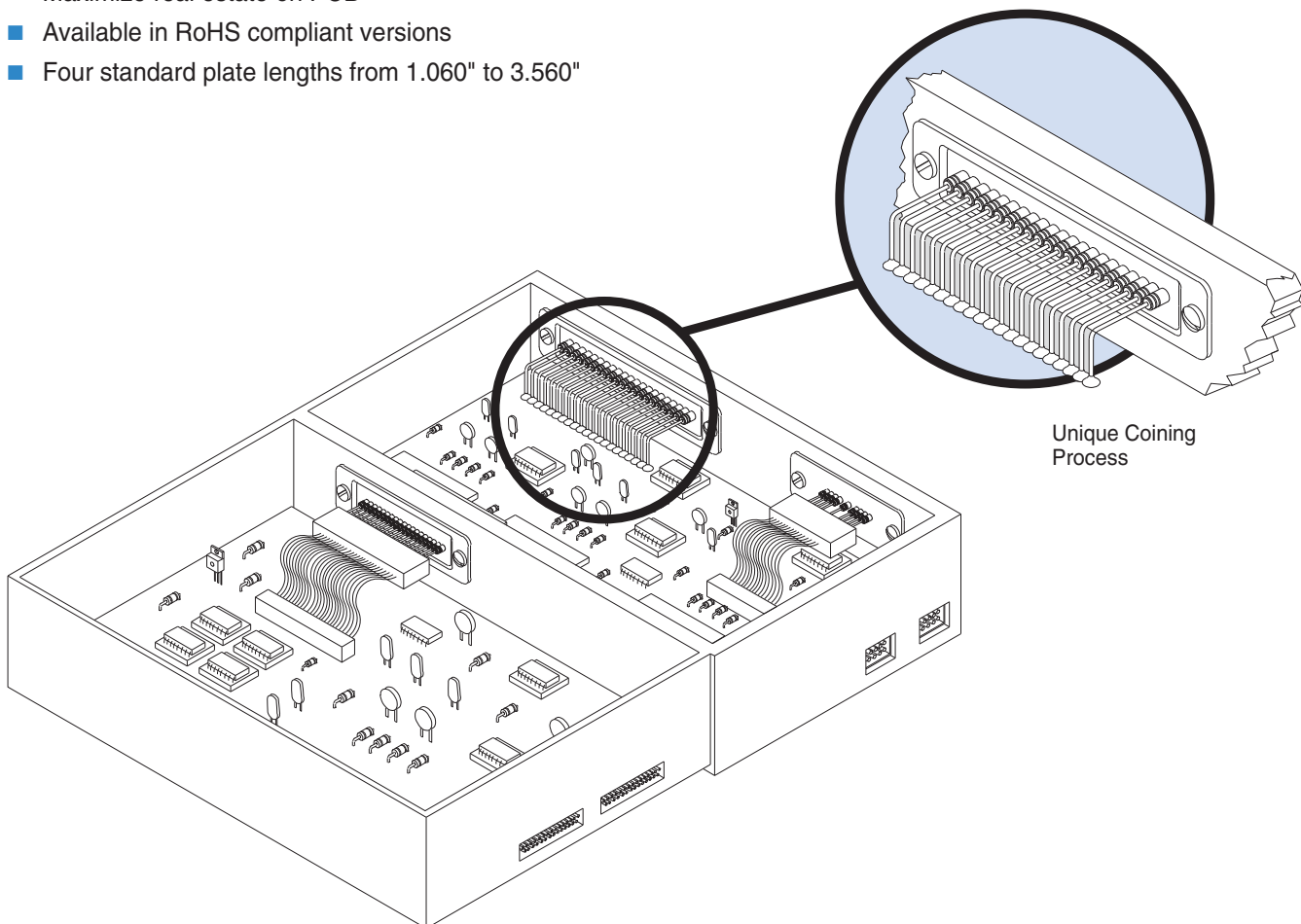

Filtered Arrays

# Barrier Strip Filtered Terminal Blocks

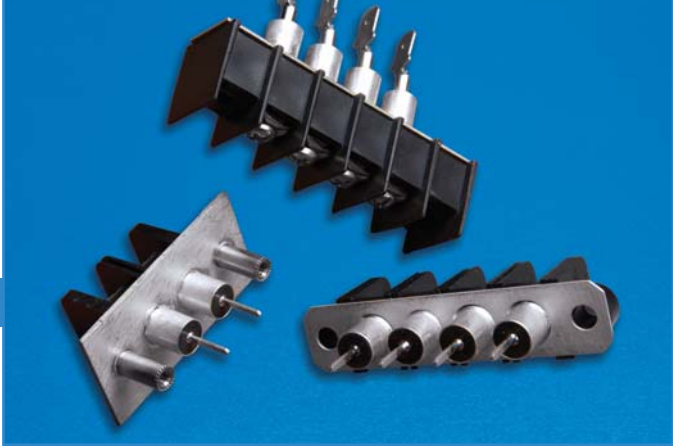

The barrier strip filtered terminal block is designed to provide excellent EMI/RFI filtering of AC and DC power lines and control lines. This terminal block is available in various sizes, with terminals for soldering or spade lugs. Application examples include filtering power supplies in telecommunications equipment, metering, industrial controls, instrumentation and EDP equipment.

## Features

- UL recognized and CSA approved for DC voltages
- E133076, UL 1059
- LR92537, CSA STD 22.2 N°158-1987 and ECN584B
- Filter element provides high insertion loss for EMI/RFI filtering of AC and DC power and control lines
- Rugged construction provides protection to filtering element; especially useful for repeated changes in wiring or field connections
- 2 to 6 terminals available (combine if larger number of terminals needed)
- Cost-effective solution for industrial interconnection EMI filtering problems
- Termination options available: straight lead, male or female disconnects, pigtail (12 AWG = 0.081" (2.05mm); 22 AWG = 0.025" (0.64mm))
- Available in RoHS compliant versions

## Circuit Schematic

### Pi Filter

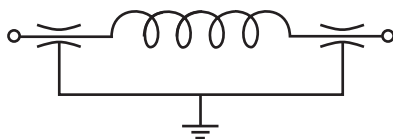

## Mechanical Specifications

- Center Spacing* . . . . .438" (11.1 mm)  
*Wire Size* . . . . . AWG #12 max for 20A  
*Screw Size* . . . . . 20A - #6-32, zinc-plated phillot screws  
*Molded Material* . . . . . Black, UL rated 94VO thermoplastic  
*Tightening Torque* . . . . . 9 in.-lbs. max.  
*Terminal* . . . . . Brass, tin-plated

## Electrical Specifications

- Operating Temperature* . . -55°C to 105°C  
*Working Voltage* . . . . . 100VDC  
*Capacitance* . . . . . 2,500 pF to 5,200 pF  
*Dielectric*  
*Withstanding Voltage* . . . 1700VDC  
*Current Rating* . . . . . 20A  
*D.C. Resistance* . . . . . .01 ohms max.

Note: For product with AC rating, consult factory for 52-257-Series product and request data sheet. Product UL/CSA recognized.

## Typical Loss (dB) In 50 Ohm Circuit

Frequency	Insertion Loss (dB)
30 MHz	22
50 MHz	32
100 MHz	48
300 MHz	70
500 MHz	75
1000 MHz	75

Filtered Arrays

# Custom Filtered Arrays

API Technologies' Spectrum Control brand will custom design a filter plate or terminal block that meets your size, material and filtering requirements. We have engineered a variety of capacitive only filter elements that provide excellent RF isolation from 5 MHz to 1 GHz and beyond. In addition, we are capable of providing stringent testing and analysis of our filter plate or terminal block assemblies to MIL-F-15733 and MIL-F-28861.

In addition to our standard and custom filter plates and terminal blocks, we offer a number of value-added features designed to complement your manufacturing operation. Our marketing and engineering staff will evaluate your design or manufacturing parameters and develop a filter solution which provides increased filtering performance economically.

## API Capabilities

- Custom assemblies with varying cable lengths and terminations
- Integrate a filter solution with other components to ensure a completely functional device
- Perform EMC evaluations on your equipment, recommending proper placement of EMI/RFI filtering components
- Custom high reliability assemblies

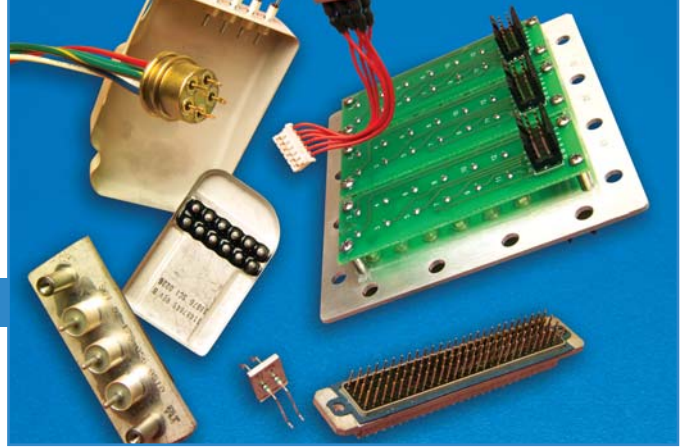

## Filtered Headers

Replace the unfiltered connector on your PC board with API's low cost filtered header. This innovative new product allows you to meet EMC emissions and susceptibility standards with minimal or no board change.

## Flat Conductor Cables

Flat conductor cables are often selected as an effective method of interconnection. API can save you time and money by installing conductor cables to your filter plates. Flat conductor cables are available in varying lengths, conductor counts and in several termination configurations.

## Lead Stabilizer

API Technologies' Spectrum Control brand has developed a filter plate lead stabilizer bar to protect leads during installation and ensure proper alignment to PCB.

Filtered Arrays

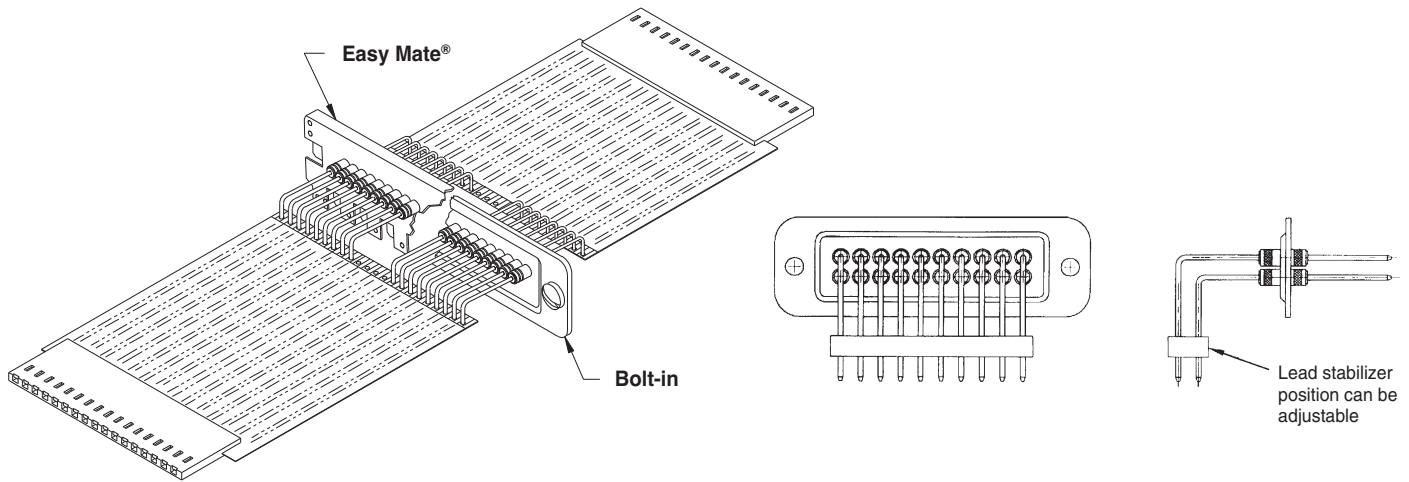



# EMI Filtered Connectors

*from performance to board space, to cost, we offer many reasons and options for managing EMI at the signal & power I/O*

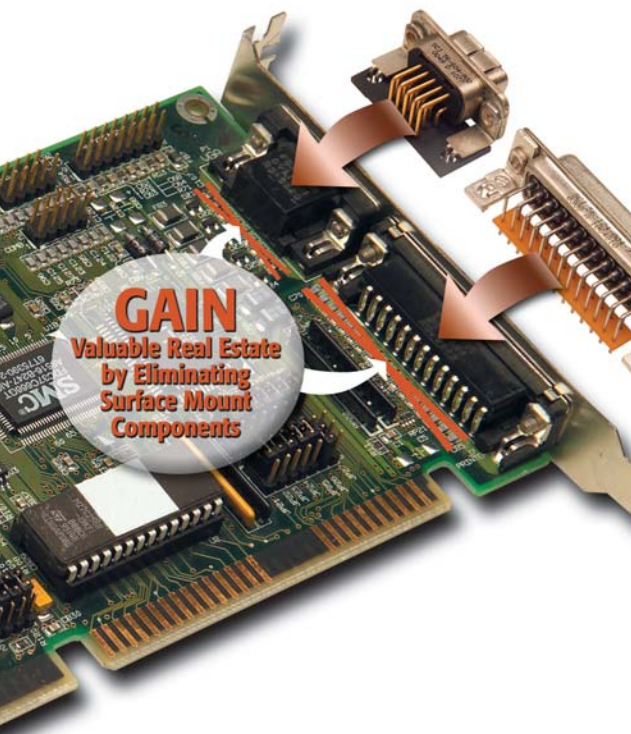

**Series F Ferrite Filtered Connectors** offer a low cost, space saving solution for high frequency interference... **39**

**Series 500 Low-Profile Feed-Through Connectors** deliver reliable EMI filtering in 90° PCB and straight PCB connectors... **40**

**Series 600 High-Density Filtered Connectors** meet the growing need for increased circuit densities in smaller packages... **41**

**Series 700 High Performance Connectors** feature feed-through capacitive and Pi filters for the most effective filtering... **42**

**Filtered Combo D-Sub Connectors** use tubular capacitors for high insertion loss in signal, power and coaxial contacts... **43**

**Micro D Series Connectors** allow designers to incorporate EMI filtering into even smaller packages... **44**



## Advantages of a Filtered Connector

- **Low ground impedance** – Full ground plate and metallic shell provide minimal impedance and superior performance compared to on-board filter with high impedance
- **Eliminate re-radiation** – Filtered connector at interface leaves no path for bypassing the filter
- **Ground plane shielding** – API's filtered connector ground planes shield the box even at the connector port
- **Efficient space utilization** – Filters located in the connectors provide additional space on PCB board
- **Consistent performance** – Filtered connectors provide more consistent pin to pin performance
- **Fewer components** – Filtered connectors reduce component count creating cost savings
- **Reliability** – API tests 100% of filters, on-board filters are usually spot tested

# D-Subminiature Part Numbering System

## Ordering Information

Example: **56-513-012-TI**

**56** - **5** **1** **3** - **0** **12** - **TI**

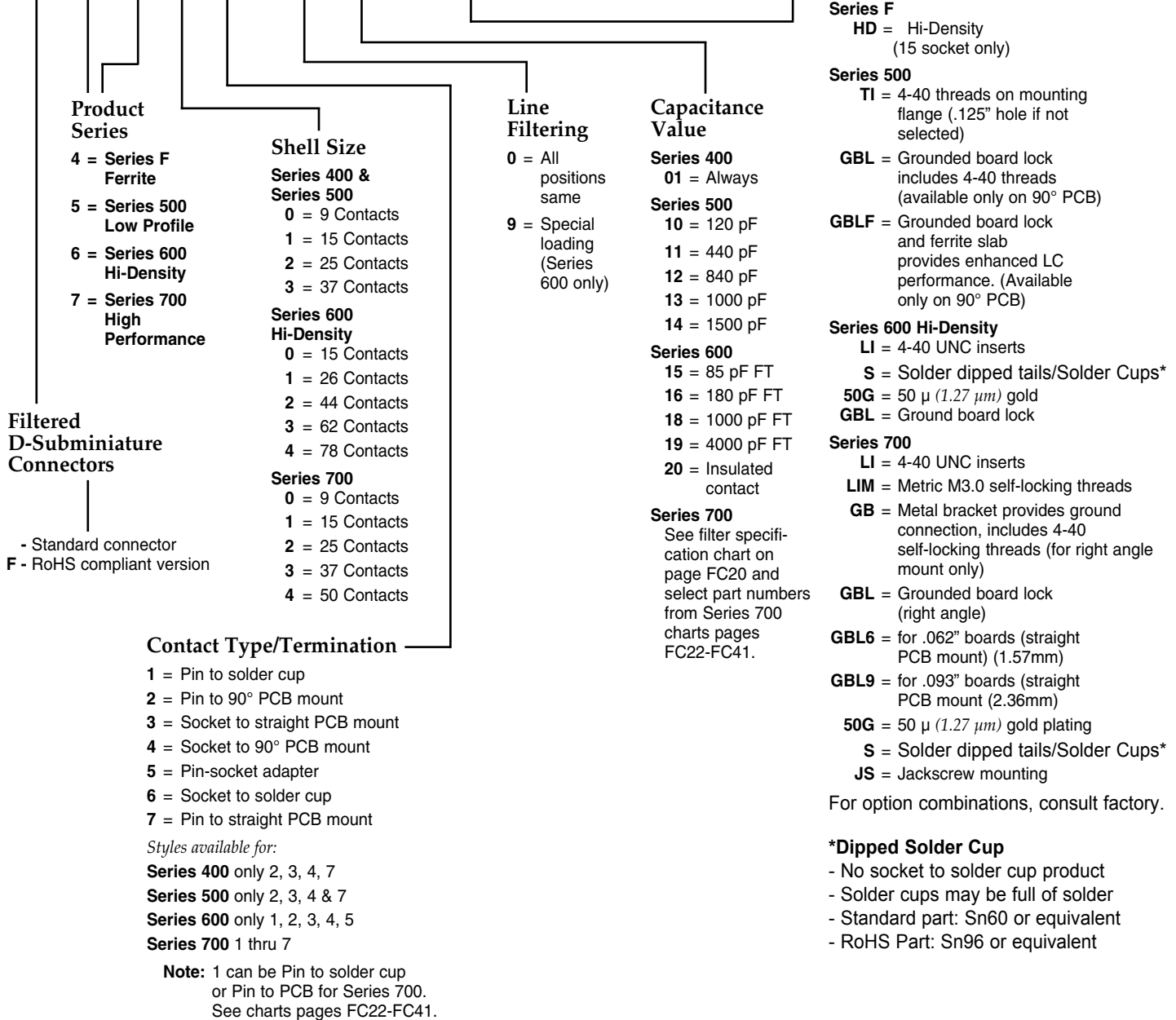

To assist your efforts in selecting the correct Filtered Connector to meet your needs, we have developed a part numbering system. All of the standard products are shown in their respective catalog pages.

Part number **56-513-012-TI** represents a Series 500 connector with 15 contacts in a socket to straight PCB mount configuration. All connector positions have a capacitance value of 840 pF and there are 4-40 threads on mounting flange.

# Series F Ferrite Filtered Connectors

The Series F filtered D-subminiature connectors incorporate a solid slab of ferrite material as the filtering element. This rugged one-piece design provides a compact connector that is a drop-in replacement for standard connectors. The ferrite material has been chosen for optimum filtering performance in the 10 to 300 MHz range.

## Features

- Low cost, high performance ferrite filter
- No distortion of wave forms
- Replaces individual ferrite bead filters, saving cost and space
- Provides both pin to ground and pin to pin filtering
- Effective in helping meet requirements of FCC, VDE, EN55022 and Japan's VCCI
- Short, space saving .318" footprint
- Interchangeable with standard D-subminiature connectors
- Can be installed directly over PCB trace pattern with no shorting
- 4–40 UNC locking insert eliminates loose hardware
- Metal shielding front shell
- Gold plated contacts
- RoHS compliant versions available (replace 56- with 56F)

## Applications

- Personal computers, microcomputer-applied products and peripheral/terminal equipment
- Eliminates common-mode noise along data lines in data communication terminals and digital equipment

## Mechanical Specifications

Front Shell . . . . . Steel (Tin plated)  
 Housing . . . . . UL 94V-0 Rated thermoplastic, black  
 Contacts . . . . . Phosphor bronze (sockets) or brass (pins)  
 Contact Plating . . . . . Gold flash (<10µ in.) over nickel  
 Operating Temperature . . . . . -40°C to +105°C

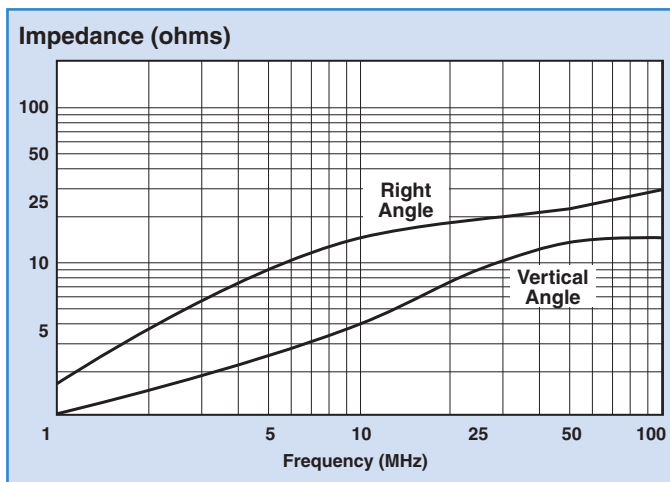

## Electrical Specifications

Frequency (MHz)	Impedance (Ohms)	
	Right Angle	Vertical
1	2	1
10	15	6
30	20	10
50	23	12
100	27	15

Frequency Range . . . . . 10 – 300 MHz  
 Current Rating . . . . . 5 Amps  
 Dielectric Withstand Voltage . . . . . 1000 VAC for one minute  
 Insulation Resistance . . . . . 1000 MΩ Min. @ 500VDC



# Series 500 Low Profile Filtered Connectors

API's Spectrum Control brand of Series 500 are cost effective, highly reliable EMI filtered D-subminiature connectors that feature a .318" footprint for 90 degree PCB connectors and a low profile housing on straight PCB connectors. Series 500 filtered D-sub connectors are "drop-in" replacements for standard unfiltered D-sub connectors and use tubular capacitors for high performance EMI filtering.

Series 500 capacitive filtered D-sub connectors are an ideal solution to FCC/EC/VCCI emissions problems. These connectors are designed to protect equipment from external EMI noise and eliminate system glitches.

## Features

- "Drop-in" replacements for unfiltered D-subminiatures
- Compact design, featuring .318" footprint
- Tubular feed-through capacitors provide filtering superior to on-board components
- Ground plane design provides EMI shielding
- Full interchangeability; based on MIL-C-24308
- Each connector position is tested 100% for critical electrical parameters to ensure consistent performance
- Insulators are UL recognized UL94-V0 flammability rated
- 9, 15 and 25 shell sizes
- Available with board lock feature and 4-40 mounting threads
- Selective filtering available
- UL/CSA approved
- Greater than 40 dB filtering up through 1 GHz without resonances
- Bi-directional control of EMI at the I/O ports

## Mechanical Specifications

Shell	Steel, tin plated
Insulators	Glass-filled polyester, flammability UL94V-O
Pin Contacts	Copper alloy CA725, 15 microinch (0.38 μm) gold plated* over nickel
Socket Contacts	Copper alloy CA725, 30 microinch (0.76 μm) gold plated* over nickel

\*Heavier gold plating available upon request.

Ground Plane	Phosphor bronze, nickel plated
Operating Temperature	-40°C to +125°C
Capacitors	Proprietary barium titanate ceramic formulations



## Typical Insertion Loss

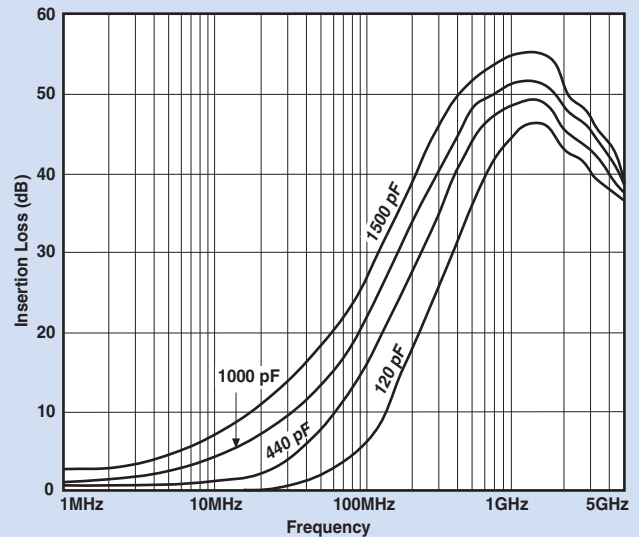

840 pF is typically within 2 dB of 1000 pF curve.

## Electrical Specifications

Current Rating	5 Amps
RF Current Rating	0.3 Amps
Contact Resistance	10 mΩ maximum
Capacitance	120, 440, 840, 1000, 1500 pF ±30%
Working Voltage	100 VDC
Dielectric Withstanding Voltage	300 VDC
Insulation Resistance	1 GΩ minimum
UL Recognized	Under category of communication circuit accessories, File #E149046

## Series 600 High-Density Filtered Connectors

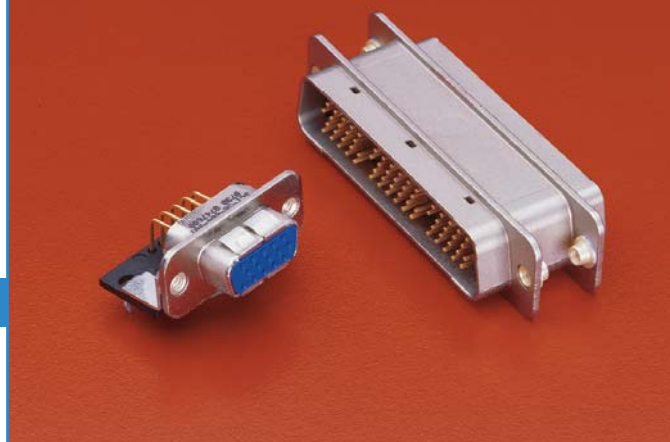

The miniaturization of electronic systems and sub-systems is pushing designers to increase circuit densities within smaller packages. To address this growing need, API Technologies' Spectrum Control brand has developed a line of filtered High-Density D-subminiature connectors. This new line of connectors incorporates the high performance and reliable filtering of API's standard D-subminiatures in the High-Density format.

### Features

- Connectors designed to MIL-C-24308
- Capacitance values from 85 pF to 4000 pF
- Filter type feed-through C
- Selectively specify and filter each contact position
- Available in feed-through capacitive configurations

### High-Density Filtered Adapter for Telecommunications

In response to the unique requirements of the telecommunication industry, we have developed a new High-Density filtered adapter.

### Features

- New ceramic technology and filter element construction to accept higher voltages
- Improved reliability compared to "ribbon" type connectors
- Integral ground plane and one-piece diecast housing for the highest level of EMI integrity
- More contacts/wires per square inch of panel space through High-Density arrangements
- 64 contact positions standard, with 78 positions available by request in any filter combination
- Meet Bellcore TR-NWT-001089 requirements
  - 1000 volts AC withstand for one minute
  - 2500 volts spike surge testing

### Mechanical Specifications

- Shell* . . . . . Zinc diecast, nickel plated  
 150  $\mu$  inches (3.81  $\mu$ m) min.
- Insulators* . . . . . Thermoplastic, UL94V-0
- Contacts* . . . . . One-piece, screw machined  
 Copper alloy, contact area plated  
 50  $\mu$  inches (1.27  $\mu$ m) gold  
 over 50  $\mu$  inches (1.27  $\mu$ m) nickel
- Ground Plane* . . . . . Brass, solder plated

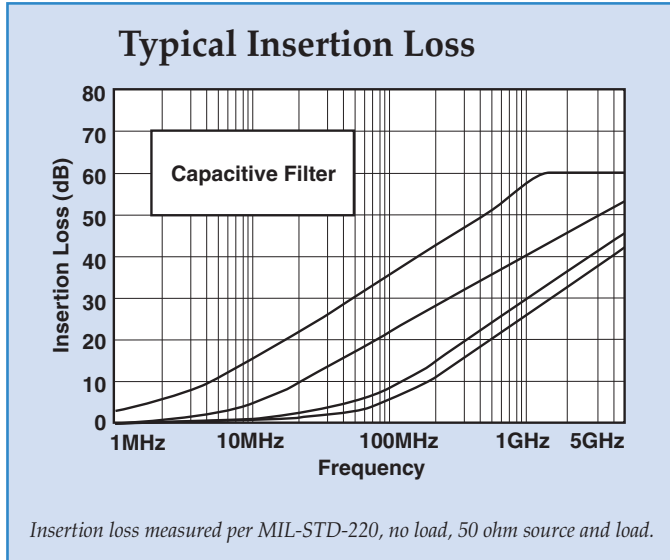

*Grounding Springs* . . . . . Beryllium copper, tin plated per MIL-T-10727

*Operating Temperature* . . . . . -55°C to +125°C

*Capacitor* . . . . . High performance ceramic feed-through utilizing ultra low ESR design

### Electrical Specifications

- Voltage Rating* . . . . . 100 VDC
- Current Rating* . . . . . 3 Amps
- Contact Resistance* . . . . . 15 m $\Omega$  max.
- Dielectric Withstanding Voltage* . . . . . 1000 VRMS (FCC Part 68 test)
- Capacitance* . . . . . 1000 pF,  $\pm$ 25%
- Voltage Surge* . . . . . Meets 2500 volts surge (10/1000)
- UL Recognized* . . . . . Under category of communication circuit accessories, File #E149046

Note: VGA adapters also available. Consult factory.

For complete specs and drawings, visit [eis.apitech.com/series600](http://eis.apitech.com/series600)

# Series 700 High Performance Filtered Connectors

These connectors are a highly effective method of filtering at the I/O interface. The ability to selectively filter lines allows signals of various rates to pass without degrading signal integrity. Series 700 connectors feature a .590" footprint on right angle connectors. Styles are available with pin or socket contacts or as pin/socket adapters.

## Features

- Available in 9, 15, 25, 37 and 50 shell sizes
- One-piece die cast housing design
- Available in both feed-through capacitive and PI configurations
- Selective line filtering is available
- Tubular capacitor filtering provides effective performance through 10 GHz
- RoHS compliant versions available

## Mechanical Specifications

<i>Shell</i> . . . . .	Zinc diecast, nickel plated 150 $\mu$ inches (3.81 $\mu$ m) min.
<i>Insulators</i> . . . . .	Glass-filled polyester, flammability UL94V-0
<i>Pin Contacts</i> . . . . .	Copper alloy, 15 $\mu$ inches (0.38 $\mu$ m) gold plated * over nickel
<i>Socket Contacts</i> . . . . .	Copper alloy, 30 $\mu$ inches (0.76 $\mu$ m) gold plated * over nickel
* Heavier gold plating available upon request.	
<i>Terminations</i> . . . . .	Gold flash for PCB mount and solder cups. Solder dipped also available.
<i>Ground Plane</i> . . . . .	Brass, solder plated
<i>Grounding</i>	
<i>Springs</i> . . . . .	Beryllium copper, tin plated per MIL-T-10727
<i>Capacitors</i> . . . . .	Proprietary barium titanate ceramic formulations



EMI Filtered Connectors

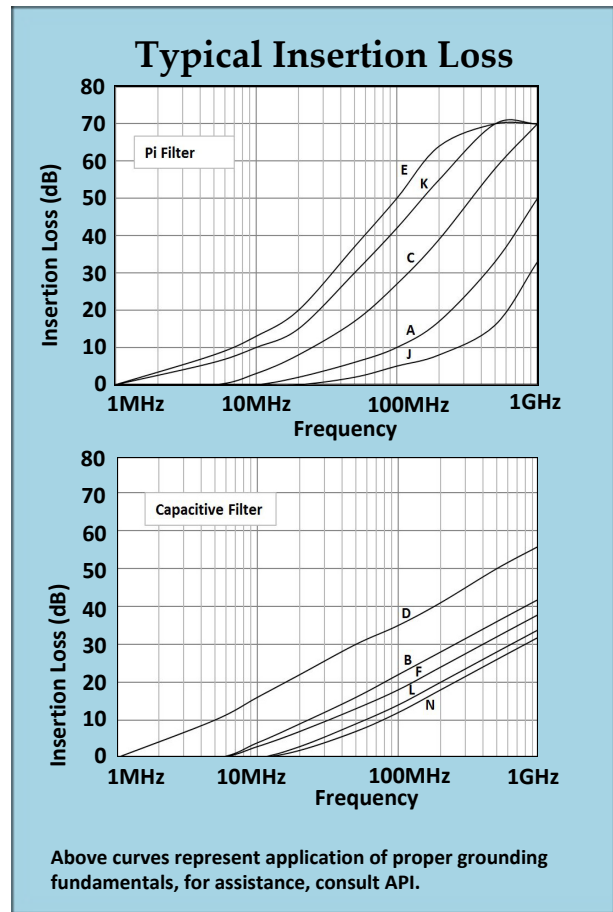

*Insertion loss measured per MIL-STD-220, no load, 50ohm source and load.*

## Electrical Specifications

- Current Rating* . . . . . 5 Amps
- RF Current Rating* . . . . . 0.3 Amps
- Contact Resistance* . . . . . 10 m $\Omega$  maximum
- UL Recognized* . . . . . Under category of communication  
circuit accessories, File #E149046
- Inductance on*
- PI Filters* . . . . . ~ 860 nH between 100 kHz  
and 1 MHz
- Operating Temperature* . . . -55°C to +125°C
- Solder cups accept up to a 20 gauge wire



# Filtered Combo D-Subminiature Connectors



API's Spectrum Control line of filtered combo D-sub provide high insertion loss with capacitive filtering. These connectors are available with 20 Amp power contacts or 40 Amp power contacts. Configurations include male and female versions with straight PC terminals, right angle PC terminals or solder cup terminals. Standard D-sub shell sizes provide intermateability with unfiltered connectors. High strength epoxy potting protects ceramic elements.

Capacitive filtering is available in 470, 820, 1000 and 1500 pF. Additional capacitance ranges and configurations can be provided upon request. Please consult factory for more information.

## Applications

- Telecommunications base station equipment
- Switching and transmission equipment
- Power supplies
- Industrial equipment
- Computer work stations

## Models

- 3W3 in plug-solder cup and plug-right angle
- 5W5 in plug-vertical
- 9W4 in socket-solder cup, socket-vertical and plug-right angle
- 24W7 in socket-solder cup

## Ordering Information

Example: **563A03W3101GBL9**

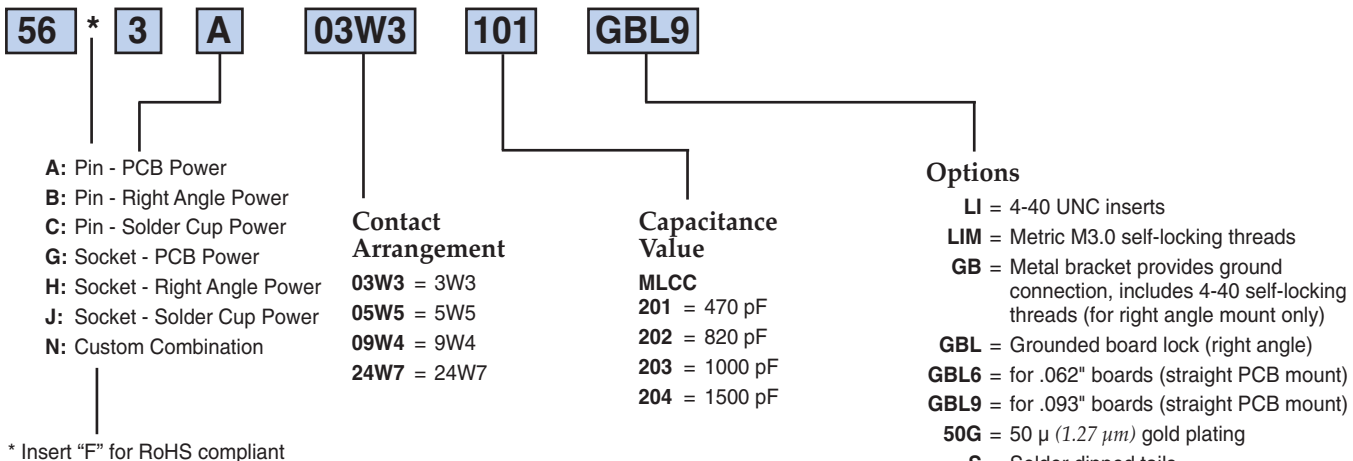

\* Insert "F" for RoHS compliant

## Mechanical Specifications

<i>Shells</i> . . . . .	Steel, tin plated
<i>Power Contacts</i> . . . . .	Brass, gold plated .000030 in. (0.762 μm) minimum
<i>Signal Contacts</i> . . . . .	Pin: brass, gold plated .000015 in. (0.762 μm) min. Socket: copper alloy, gold plated .000030 in. (0.762 μm) min.
<i>Insulator</i> . . . . .	Glass-filled polyester, flammability UL94V-0
<i>Operating Temperature</i> . . . . .	-55°C to +125°C
<i>Capacitors</i> . . . . .	MLCC

## Electrical Specifications

<i>Operating Voltage</i> . . . . .	200 VDC
<i>Current Rating*</i> . . . . .	40 Amp power/ 5 Amp signal
<i>Insulation Resistance</i> . . . . .	1 GΩ at 100 VDC
<i>Capacitance</i> . . . . .	See below for MLCC values. For other capacitance values contact factory.
<i>Dielectric Withstanding Voltage</i> . . . . .	600 VDC

\*30 Amp available. Consult factory.

# Filtered Micro D Series Connectors

For designs that require even smaller connector packages, API's Spectrum Control brand has designed a line of filtered Micro D-Subminiature connectors. This line of connectors offers a range of reliable filtering options, including capacitive and ESD versions, and several sizes and termination options. API has a Micro D-sub connector to satisfy your smallest space constraints.

## Features

- Light weight
- Compact size
- Environmentally sealed contact area when mated
- Corrosion resistant
- Durable (500 cycles min.)
- Superior electrical performance
- RoHS compliant

## Applications

- Peripheral and terminal equipment
- Industrial process equipment
- Cellular base stations
- Telecommunications equipment
- Graphics workstations
- Medical electronics
- Aerospace applications

## Ordering Information

Example: **56-F011-110-JP**

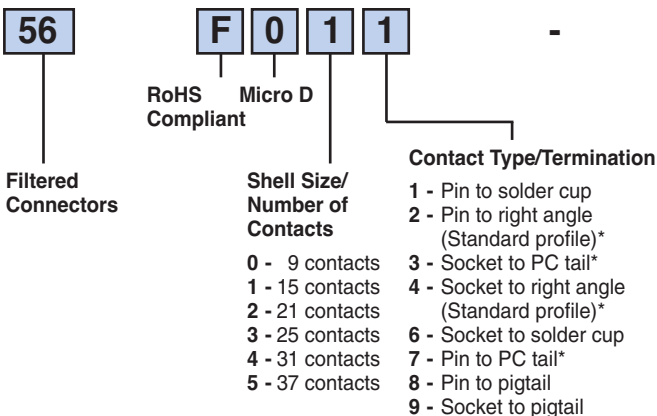

## Mechanical Specifications

<i>Shell</i> . . . . .	Aluminum, electroless nickel plated 500 μ in (12.7 μm) minimum
<i>Insulator</i> . . . . .	Glass filled polyester, flammability UL94V-0
<i>Contacts</i> . . . . .	Copper alloy, gold plated 50 μ in (1.27 μm) minimum
<i>Potting</i> . . . . .	Flammability UL94V-0
<i>Interfacial Seal</i> . . . . .	Silicon

## Electrical Specifications

<i>Operating Voltage</i> . . . . .	100 VDC
<i>Dielectric Withstanding Voltage</i> . . . . .	300 VDC
<i>Current Rating</i> . . . . .	3 Amps
<i>Insulation Resistance</i> . . . . .	5G ohms @ 100 VDC

*This part number represents a micro D-sub connector with a shell size of 15 and a pin to solder cup configuration. All lines are filtered with same capacitance value, which is 100 pF COB. The connector includes an optional #2-56 jack post.*

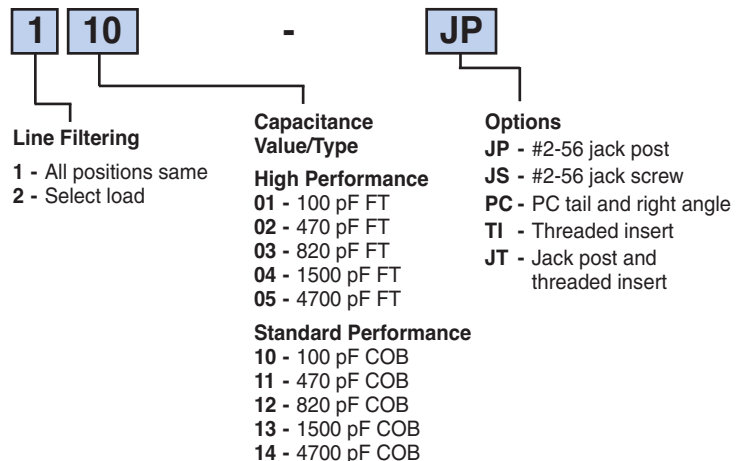

\* Right angle and PC tail length (Standard Profile) is 0.109. Other lengths available, consult factory.

All capacitance values ±20% @ 25°C

# Quietshield™ Gaskets & Shielding

*flexible, conformable and lightweight Quietshield™ products deliver effective EMI shielding across seams or gaps within an enclosure*

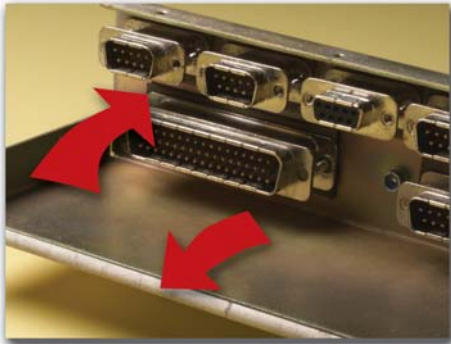

**Foam Over Fabric** are low cost, soft and easy to apply. These gaskets are available in a variety of materials and profiles, including rectangular, "D" shaped, FL shaped and DD shaped.

**Waved Metal Gaskets, Fabric Over Foam Gaskets and I/O Connector Electromagnetic Shielding Gaskets** are flat products used to provide a ground contact between a metal connector and the electronic enclosure or mating connector.

**Shielding Tapes and Fabrics** are flexible, lightweight, and easy-to-install shielding materials offering high conductivity with a low electrical resistance and are available in a variety of fabric styles.

**Wire Mesh Gaskets** are available as all mesh or elastomer core mesh gaskets. They provide excellent heat and corrosion resistance and are used between two surfaces to maintain electrical continuity while shielding electromagnetic waves.

**Conductive Silicone** is used for its heat resistant properties and can be produced in many different forms such as sheets, molded parts, die-cuts or strips. These conductive elastomers are water resistant, can eliminate static electricity, and act as an absorber at high frequencies.





# Quietshield™ Part Number System

Example: **57D1211205 - 7200**

The part number shown represents a foam-over-fabric gasket with woven foam made of neoprene, conductive PSA. The gasket has copper-nickel plating that is 0.120" wide x 0.050" thick x 72" long.

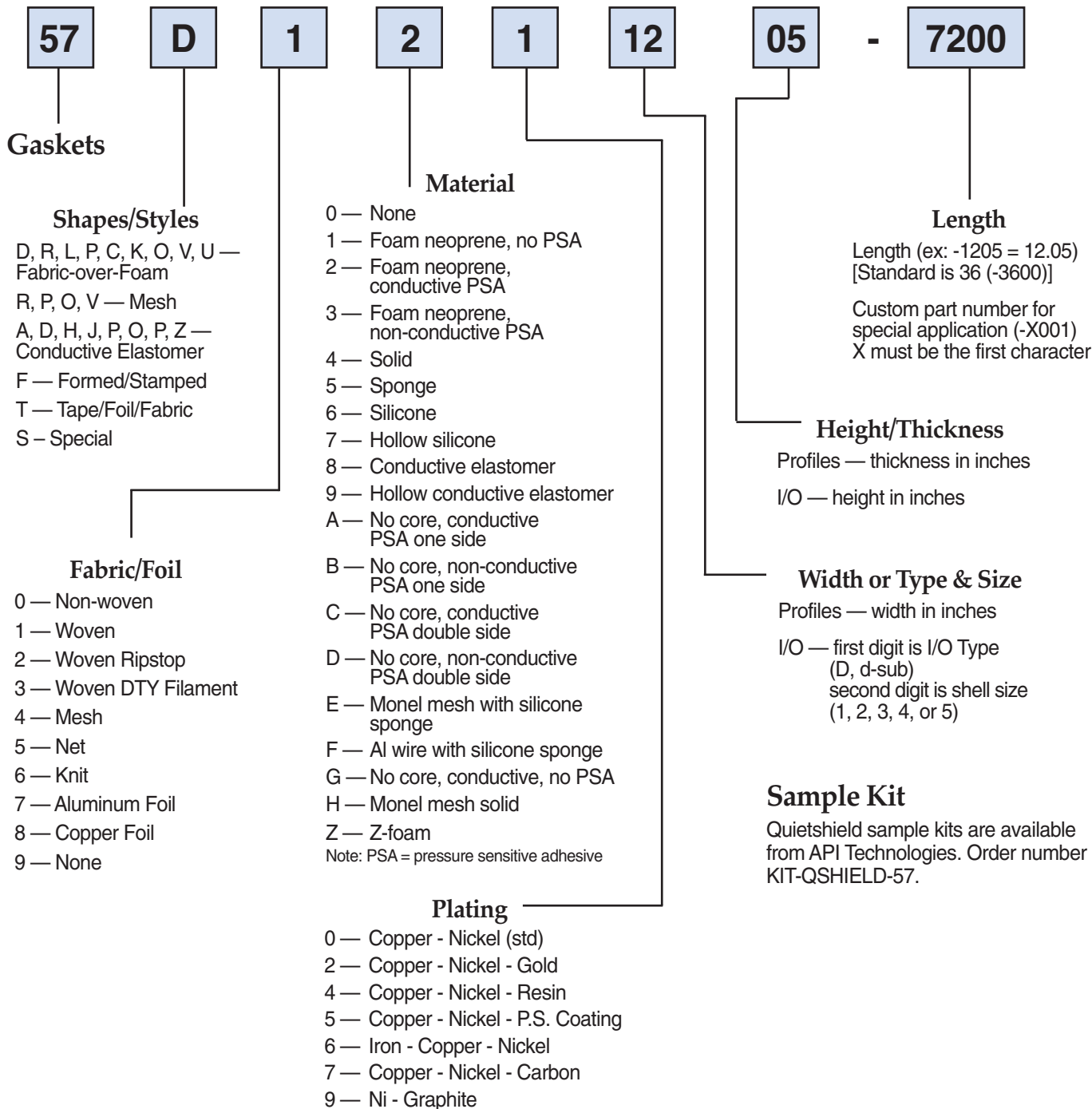

Gaskets & Shielding

# Specialty Connectors & Custom Cable Assemblies

*a premium line of custom and specialty filtered and unfiltered connectors with a range of value-added cable and harnessing products*

**Custom Filtered Connectors** provide filtered versions of MIL-STD connectors in custom configurations. Tubular and planar filtered arrays are available with Pi, LC, T and C circuits... 49

**Custom Unfiltered Connectors** are built to meet various environmental requirements and MIL specifications with power, signal and coax line combinations and multiple terminations available... 49

**Mini-MIL Connectors** offer space and weight savings with MIL-DTL-38999 equivalent performance... 50

**Rapid Mate Connectors** provide positive mating force to ensure a reliable connection, offering the ease and reliability of hot shoe style mating with the added benefit of integral EMI filtering... 51

**Harnessing Products and Services** are designed in accordance with IPC-A-610 and J-STD-001 for military, commercial and industrial applications. We provide assemblies for both unfiltered and filtered interconnects including lead wire preparation, soldering and tinning, marking and ribbon cable processing... 52

**Custom Cable Assemblies** include discrete and signal cables, RF cables, power cables, system integration and overmolded connector backshells... 53



- Audio, circular and hermetically sealed connectors
- Connector harnessing built to IAW, IPC-A-610 and J-Std-001
- Complete electro-mechanical assembly and testing services
- Custom connectors can be designed to meet RTCA/DO-160 Section 22 Lightning Strike
- EMI filtered connectors with complex schematics available

# Specialty Connectors



## Custom Filtered Connectors for MIL & Hi-Rel Applications

API Technologies' Spectrum Control brand offers a complete line of compact and extended shell filtered connectors providing a wide range of design flexibility. Our compact shell filtered connectors offer designers an effective filtering device that reduces the amount of real estate required within a product enclosure. Our extended shell connectors are constructed by adding API's planar or tubular capacitor filtering to the rear of a standard connector, which makes them ideal when quick turnaround is required for prototype devices.

Styles offered include the following, as well as custom designs.

- MIL-DTL-38999
- MIL-DTL-55116
- MIL-DTL-83723
- MIL-DTL-24308
- MIL-DTL-26482
- MIL-DTL-5015

We offer tubular and planar style filtered arrays in Pi, LC, T and C circuits with TVS protection also available. Reliability is ensured through 100% testing of each position for critical electrical parameters.

## Custom Unfiltered Connectors

API also offers unfiltered custom connector design and manufacturing. Parts can be designed to meet your mechanical and environmental specifications or those of similar QPL connectors.

### Features

- Built to MIL specifications
- Custom shells to fit your available space
- Multiple terminations available
- Built to meet various environmental requirements
- Integral strain relief
- Power, signal and coax line combinations

## Vertically Integrated

API's Spectrum Control line of custom filtered and unfiltered connector offerings are fully vertically integrated. Components including capacitors and shells are manufactured by API, providing our customers high quality parts at very competitive prices, with the industry's shortest lead times.

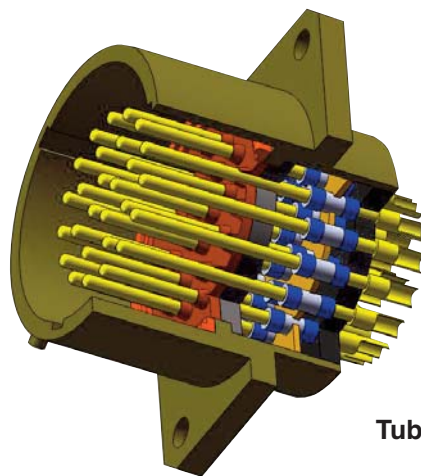

**Tubular Filtered Connector**

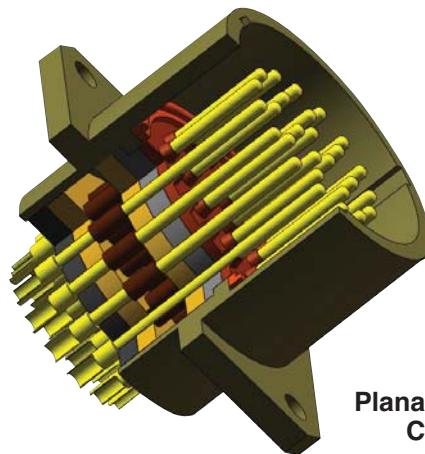

**Planar Filtered Connector**

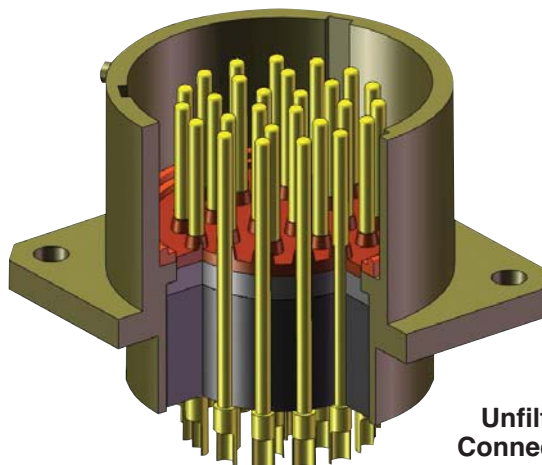

**Unfiltered Connectors**

Specialty Connectors & Custom Cable Assemblies



# Mini-MIL Connectors

API's Spectrum Control line of Mini-MIL circular connectors are small and lightweight offering space and weight savings while providing equivalent performance to standard MIL-DTL-38999 connectors. These connectors are available filtered with C, Pi or mixed capacitance, or unfiltered, and can be customized to satisfy various mechanical and electrical requirements. These connectors are ideal for military, industrial and medical applications where space restrictions do not allow for larger 38999 connectors.

## Specifications

### Engagement Types:

- Bayonet
- Single-start UN thread
- Double-start ACME thread
- Triple-start ACME thread

### Termination Types:

- PC tail
- Solder cup
- Crimp removable
- Piggyback socket
- Custom

### Receptacle Types:

- Flange mount (front or rear mount)
- Jam nut (front or rear mount)
- In-line

Specialty Connectors & Custom Cable Assemblies

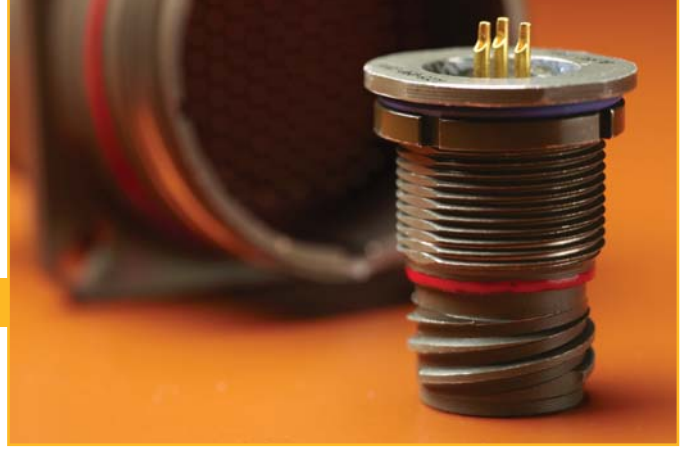

## Mechanical Specifications

- Shell* . . . . . Eight shell sizes are available in either pin or socket contact genders
- Shell Materials* . . . . . Aluminum, stainless steel, composite, custom
- Contacts* . . . . . Pin and socket contacts are available in 1 to 55 contacts in various combinations of size 23 to size 12.

## Electrical Characteristics with C Filter

Capacitance (pF, GMV)*	Working Voltage		Dielectric Withstanding Voltage (VDC)	Minimum Insertion Loss (dB)					
	DC 85°C	AC 85°C		Cut-Off Freq. MHz	1 MHz	10 MHz	100 MHz	500 MHz	1,000 MHz
1,000	200	115	500	5	—	4	21	34	39
2,000	200	115	500	1	—	9	26	39	44
3,000	200	115	500	1	—	12	30	43	48
5,000	200	115	500	1	1	16	34	46	52
7,000	200	115	500	1	3	19	37	49	55
10,000	200	115	500	1	4	21	39	52	57
20,000	100	—	250	.50	9	26	44	57	58

## Electrical Characteristics with Pi Filter

Capacitance (pF, GMV)*	Working Voltage		Dielectric Withstanding Voltage (VDC)	Minimum Insertion Loss (dB)					
	DC 85°C	AC 85°C		Cut-Off Freq. MHz	1 MHz	10 MHz	100 MHz	500 MHz	1,000 MHz
1,000	200	115	500	5	—	4	28	54	65
2,000	200	115	500	1	—	8	39	65	70
3,000	200	115	500	1	—	11	47	70	70
5,000	200	115	500	1	1	14	54	70	70
7,000	200	115	500	1	3	18	60	70	70
10,000	200	115	500	1	4	22	64	70	70
20,000	100	—	250	.50	9	33	70	70	70

\* Custom values available.

# Rapid Mate Connectors



API's Spectrum Control brand Rapid Mate connectors offer the ease and reliability of hot shoe style mating with the added benefit of integral EMI filtering. By mating via spring loaded, compliant contacts, Rapid Mate connectors provide positive mating force to ensure a reliable connection. This method provides rapid connection with low mating force, allowing for some misalignment during mating.

Additionally, the EMI filter experts at API can design a filtered Rapid Mate connector built to your requirements, providing the advantages of hot shoe style mating while ensuring system functionality in EMI-prone applications.

## Applications

- Military and commercial communications systems
- Thermal and ambient light imaging cameras
- Docking stations
- Scanners

## EMI Filter Performance

The electrical characteristics table indicates the performance of feed-through capacitors and Pi type filters. Utilize this information to specify the EMI filtering components included in your connector. Selective loading and custom values can also be designed.

## Features

- Custom filtering
- 100% tested before shipment
- Rugged and reliable
- Resists sand, dust and water
- Low, flexible mating force

Filter Designation	Filter* Circuits	Capacitance		3 dB Max Cut-off Frequency (MHz)	Working Voltage DC -55°C to +125°C	Minimum Insertion Loss - Decibels (dB) 50 ohm system per MIL-STD-220 (no load)							
		Value	Tolerance			5 MHz	10 MHz	20 MHz	50 MHz	100 MHz	200 MHz	500 MHz	1 GHz
A	C	68 pF	±20%	77	100V	—	—	—	—	—	3	10	16
B		100 pF	±20%	53	100V	—	—	—	—	1	6	14	19
C		135 pF	+100/-0%	23	100V	—	—	—	1	5	10	16	20
D		470 pF	±20%	11	100V	—	—	2	7	13	19	25	27
E		820 pF	±20%	6	100V	—	2	6	12	18	24	30	33
F		1000 pF	±20%	5	100V	—	3	7	14	20	26	32	35
G		1500 pF	±20%	3.5	100V	1	4	10	16	22	29	36	37
H		2500 pF	+100/-0%	1.3	100V	5	11	17	23	29	35	38	40
I		4000 pF	+100/-0%	.8	100V	9	15	21	27	34	38	42	46
J		Insulated	10 pF	Max.	635	100V	—	—	—	—	—	—	—
K	Grounded Insert					—	—	—	—	—	—	—	—
L	Pi	68 pF	±20%	65	100V	—	—	—	—	1	6	17	23
M		100 pF	±20%	46	100V	—	—	—	—	2	9	22	28
N		135 pF	+100/-0%	25	100V	—	—	—	1	6	17	26	34
O		470 pF	±20%	11	100V	—	—	—	9	18	22	36	43
P		820 pF	±20%	6	100V	—	—	4	13	23	31	45	52
Q		1000 pF	±20%	5	100V	—	2	7	16	24	36	51	59
R		1700 pF	+100/-0%	1.9	100V	1	6	14	28	35	49	64	69
S		2500 pF	+100/-0%	1.3	50V	4	9	16	28	41	54	70	70
T		5000 pF	+100/-0%	.7	100V	9	15	28	41	53	66	70	70

# Harnessing Products & Services

API Technologies' Spectrum Control brand offers custom harnessing products and services for military, aerospace, commercial and industrial applications. Our skilled operators and supervisors work in a modern well-equipped facility to provide interconnect assemblies made to the highest workmanship standards.

Our manufacturing engineers design tooling and fixturing, which meet the tightest tolerances. From simple to complex, API can provide assemblies in compliance with all requirements.

## Product Capabilities

- Built in accordance with IPC-A-610 and J-Std-001
- Cable harnessing
- Wide range of interconnects
- Coaxial and RF cabling
- Flat ribbon cable
- High voltage
- Electro-mechanical assembly

## Manufacturing Capabilities

- Lead wire preparation
- Soldering and tinning
- Strip and removal of insulation
- Wire, component and assembly marking
- Ribbon cable processing
- Overmolding - connector backshells
- Fully automated testing includes Hi pot, continuity, insertion loss, TDR and VSWR up to 40GHz

Specialty Connectors & Custom Cable Assemblies



## Wire Harnesses

API will add wires to a filtered or unfiltered connector to allow the customer to easily install the connector into the system at a lower cost. These value-added services include adding wires terminated or unterminated to all lines or only select lines, twisted pairs and labeling of wires for easy placement in your system. We can also encapsulate the wires inside the connector adding strength to the total harness.

By contracting API to add the harness assembly, customers are assured the performance of the connector has not been adversely affected. **All of our custom connectors are 100% tested for integrity and effective performance.**

API's connector manufacturing operators are all certified to MIL-STD-2000 solder specification. We have invested in this certification to provide you with confidence that the quality of our custom construction meets the highest standards in the industry.

## Markets Served

- Medical
- MIL Spec
- Electronics
- Military instrumentation
- Automotive
- Marine
- Telecom
- Industrial



## Custom Cables Assemblies

API Technologies' Spectrum Control brand has developed a range of capabilities to produce custom cable assemblies that deliver dependable operation and cost savings in high reliability/high value applications. We can integrate any of API's extensive family of EMI connectors and components, RF filters and subsystems and power management systems or use industry standard components. As a vertically integrated manufacturer, we utilize our dedicated facility that is AS9100 Rev C/ISO 9001:2008 certified to produce the highest quality custom cable assemblies in the industry's shortest lead times. We also have in-house low and high volume PCB manufacturing capabilities.

### Signal & Discrete Cables

- Point-to-point, multi-conductor, branched harness, flex, semi-rigid, and rigid circuit card assembly
- API supplied EMI filtered and custom non-filtered connectors and EMI filters

### RF Cables

- Frequency up to 40 GHz
- Phase matching
- Rigid/semi-rigid cable
- Custom RF cable builder tool

### Power Cables

- Current ratings up to 750 amps
- Cooper "Roughneck" 4/00 + power distribution cable fabrication
- API supplied power management solutions

### Systems Integration

- In-house machining capabilities
- In-house EMI/RF filters, connectors, PDU's, turn key
- Vertically integrated manufacturing approach
- Basic box builds through complex systems
- In-house high and low volume PCB manufacturing capabilities

API custom cable assemblies are ideal for aerospace, military, high-end commercial and medical applications.



### Overmolded Connector Backshells

API offers an alternative to the traditional connector backshell that improves performance while providing significant cost savings. Our overmolded connector backshells are completely weather sealed and EMI shielded and cost a fraction of a typical connector backshell. We machine our own overmolded backshells and then seal the attached wires and shielding with an extremely durable mold material. The result is a more attractive connector that is far more resistant to environmental conditions and costs 10 to 20 times less than traditional backshells.

- API overmold backshells available for almost any connector configuration
- Overmolding provides better strain relief than heat shrink or metal backshells
- Total encapsulation of mold material protects against weather and environmental degradation
- Overmolded connector is 10 to 20x less expensive than traditional backshells
- More attractive final assembly, custom mold imprinting available

# EMI Power Filters

*find the ideal method to filter the AC or DC power entering your system to prevent radiated or conducted EMI with our line of standard power filters and custom power solutions*



**Power Entry Modules, Power Line & 3 Phase Power Filters** are designed in multiple configurations to cover a range of industrial applications. These have excellent attenuation for high voltage impulse, are available in single and dual stage and address FCC Part 15 regulations while meeting your power filtering needs... **55-57**



**Single Line Feed-Through (SLFT) Power Filters** provide superior filtering in a compact, durable package with single, dual, and triple feed-throughs available. These filters are ideal for meeting broad frequency applications with a bolt-in style for easy installation... **58-59**



**Military/Aerospace Multisection Filters** provide excellent EMI filtering for demanding high reliability applications. We offer standard filters, as well as custom designed mechanical packages for unusual or tight fitting spaces and higher performance filtering and expanded voltage ratings... **60-61**



**EMI Power Filter Solutions** will lower your costs and reduce your time to market while providing your system with protection from radiated or conducted EMI. Our comprehensive consulting, diagnostic testing and world class manufacturing allows us to meet your design/project parameters... **62-63**



## EMI Filter Expertise

We differentiate ourselves from typical filter suppliers by offering our customers an integrated approach to EMC problem solving through consulting, diagnostic testing, design and manufacturing.

- In-house test facilities to provide a total solution for your compliance issues – anechoic chamber, shielded room and NARTE certified engineers ready to test for European emission and immunity regulations, FCC Part 15 and MIL standards

- Global manufacturing and design support with agency approved products available
- Engineering expertise and vertical integration reduce your time to market and save you money
- High reliability products with low leakage and nonmagnetic options available
- Available to meet MIL-PRF-15733 and MIL-STD-461 standards



# Power Entry Modules, Power Line Filters & 3 Phase Power Filters

## Features

- Good filtering characteristics for both differential and common mode
- RoHS compliant
- Easy-to-install
- Varieties available in bolt-in or snap-in model
- Ideally suited for products that must conform to part 15 FCC regulations
- In many cases agency approvals are applicable or pending
- Both metal and plastic casing provide high performance
- Metal case provides effective EMI shielding
- In some cases product is adaptable for custom options
- IEC product meets over voltage category II of IEC 664 and complies with IEC 950
- Low leakage versions available for medical applications
- All are distribution friendly
- Design flexibility with product available for PCB mount, fast-on tab, solder lug for flying leads



Tested and found to be IAW VDE 0565 Part 3.



## Applications

- Medical equipment
- Electronic equipment
- Digital equipment
- Industrial equipment
- Telecommunications equipment
- Measuring and testing instruments
- Personal computers and peripherals
- Home appliances
- Switch mode power supplies





# Power Entry Modules, Power Line Filters & 3 Phase Power Filters Part Numbering System

## Part Numbering System

*Example: 12-PMB-025-5-A*

Part number 12-PMB-025-5A represents a power line filter with threaded studs, current rated for 25 Amps and with a leakage current of 0.50 mA.

<b>12</b>	-	<b>PMB</b>	-	<b>025</b>	-	<b>5</b>	-	<b>A</b>
↓		↓		↓		↓		↓
<b>Product Line Series</b>		<b>Product Style</b>		<b>Current Rating</b>		<b>Leakage Current (Y Cap)</b>		<b>Outline Drawing/ Case Style</b>
<b>10</b> = Filtered IEC Inlets <b>11</b> = Printed Circuit Board Mount <b>12</b> = Power Line Filters <b>13</b> = Three Phase Power Line Filters <b>14</b> = Fused or Switched & Fused Power Entry Filters (250V) <b>15</b> = Switched & Dual Fused <b>16</b> = Single Phase (250V)		<b>BBF</b> = 3 Phase, terminal block connection <b>BFF</b> = Bolt-in fused filter <b>BPF</b> = Bolt-in IEC w/Fast-on rear terminals <b>BPL</b> = Bolt-in IEC w/wire lead termination <b>BSF</b> = Bolt-in switched & fused <b>CCL</b> = Cylindrical, capacitive inputs w/Fast-ons <b>CLF</b> = Cylindrical, inductive inputs w/wire leads <b>MMB</b> = Multiple stage filtering w/threading studs <b>MMF</b> = Multiple stage filtering w/Fast-on terminal <b>MPC</b> = Miniature PCB mountable <b>PDB</b> = 3 Phase, delta w/threaded studs <b>PDF</b> = 3 Phase, delta w/Fast-ons <b>PDL</b> = 3 Phase, delta w/wire leads <b>PMB</b> = Power line filter w/threaded studs <b>PMF</b> = Power line filter w/Fast-ons <b>PML</b> = Power line filter w/wire leads <b>PWB</b> = 3 Phase, wye w/threaded studs <b>PWE</b> = 3 Phase, wye w/busbar <b>PWF</b> = 3 Phase, wye w/Fast-ons <b>PWL</b> = 3 Phase, wye w/wire leads		<b>001</b> = 1.0 Amp <b>002</b> = 2.0 Amps <b>003</b> = 3.0 Amps <b>005</b> = 5.0 Amps <b>006</b> = 6.0 Amps <b>010</b> = 10 Amps <b>015</b> = 15 Amps <b>016</b> = 16 Amps <b>020</b> = 20 Amps <b>025</b> = 25 Amps <b>030</b> = 30 Amps <b>035</b> = 35 Amps <b>050</b> = 50 Amps <b>080</b> = 80 Amps <b>100</b> = 100 Amps <b>150</b> = 150 Amps <b>160</b> = 16.0 Amps <b>200</b> = 200 Amps <b>300</b> = 300 Amps		<b>250 VAC</b> <b>125VAC</b> <b>0</b> = 0.075 mA <b>DC</b> = DC <b>1</b> = 0.01 mA <b>2</b> = 0.20 mA <b>3</b> = 0.35 mA <b>4</b> = 0.10 mA <b>5</b> = 0.50 mA <b>6</b> = 0.60 mA <b>7</b> = 0.70 mA <b>8</b> = 1.0 mA <b>9</b> = 3.0 mA <b>10</b> = 2.0 mA <b>11</b> = 1.5 mA <b>12</b> = 4.5 mA <b>13</b> = 9.0 mA <b>14</b> = 20.0 mA <b>15</b> = 15.0 mA <b>17</b> = 33.0 mA <b>18</b> = 71.5 mA <b>DC</b> = DC		<b>1</b> Select case style from following * Cylindrical * Power line w/Fast-on * Power line w/threaded studs * Power line w/wire leads * PCB mount * Large case 3 Phase delta * Large case 3 Phase wye * IEC Inlet <b>2</b> Refer to drawing list per selected case style <b>3</b> Letter at the end of the part is found in the case style drawing list: A, B, C, D, E, F, etc.

\* Note: Not all series offer the product style, rating and leakage current. See specific part number tables for each product line

# Power Entry Modules, Power Line Filters & 3 Phase Power Filters Part Numbering System

## Part Numbering System

Example: **60-BPR-060-5-4**

Part number 60-BPR-060-5-4 represents a power entry module, bolt-in style with fast-on terminals, a current rating of 6 Amps, leakage current of 0.50 mA and capacitance of 0.047  $\mu$ F.

<b>60</b>	-	<b>BPR</b>	-	<b>060</b>	-	<b>5</b>	-	<b>4</b>	
<b>Product Line Series</b>		<b>Product Style</b>		<b>Current Rating</b>		<b>Leakage Current (Y Cap)</b>		<b>Capacitance (X Cap)</b>	
<b>60</b> = Power Entry Modules <b>61</b> = Mini PCB Power Filters <b>62</b> = Power Line Filters <b>63</b> = Three Phase Power Line Filters <b>64</b> = Fused or Switched & Fused Power Entry Filters (250V) <b>65</b> = Fused or Switched & Fused Power Entry Filters (125V) <b>66</b> = Fused or Switched & Fused Low Leakage Power Entry Filters (250V) <b>67</b> = Fused or Switched & Fused Low Leakage Power Entry Filters (125V) <b>68</b> = Switched & Dual Fused Power Entry Filters <b>69</b> = Dual Fused Only or Dual Switched Only Power Entry Filters		<b>AFL</b> = Appliance filter w/ inductive input <b>AFC</b> = Appliance filter w/ capacitive input <b>ARL</b> = AFL plus bleeder resistor <b>BFF</b> = Fused filter w/ Fast-on terminals <b>BFS</b> = Fused filter w/solder lug terminals <b>BHP</b> = High frequency bolt-in for PCB <b>BHS</b> = High frequency bolt-in w/solder lugs <b>BPF</b> = Bolt-In right angle terminals <b>BPL</b> = Bolt-in w/wire leads <b>BPP</b> = Bolt-in PCB mount <b>BPR</b> = Bolt-in w/Fast-on tab terminals <b>BPS</b> = Bolt-in w/ solder lug terminals <b>BSF</b> = Bolt-in switched & fused <b>MMF</b> = Metal case w/fast-on tabs <b>MPC</b> = Miniature printed circuit board <b>PMB</b> = Metal case w/bolt-on terminals <b>PMF</b> = Metal case w/Fast-on tabs <b>PML</b> = Metal case w/wire leads <b>PPF</b> = Plastic case w/Fast-on tabs <b>PQF</b> = Plastic case w/Fast-on tabs <b>PRF</b> = Plastic case w/Fast-on tabs <b>SOF</b> = Switched filter w/ Fast-on tabs <b>SOS</b> = Switched filter w/ solder tabs <b>SPL</b> = Snap-in w/wire leads <b>SPR</b> = Snap-in w/Fast-on terminals <b>SPS</b> = Snap-in w/solder lug terminals <b>SSF</b> = Snap-in switched & fused <b>ARC</b> = AFC plus bleeder resistor		<b>010</b> = 1.0 Amps <b>015</b> = 1.5 Amps <b>016</b> = 1.6 Amps <b>020</b> = 2.0 Amps <b>030</b> = 3.0 Amps <b>040</b> = 4.0 Amps <b>050</b> = 5.0 Amps <b>060</b> = 6.0 Amps <b>080</b> = 8.0 Amps <b>100</b> = 10.0 Amps <b>150</b> = 15.0 Amps <b>160</b> = 16.0 Amps <b>200</b> = 20.0 Amps <b>300</b> = 30.0 Amps <b>400</b> = 40.0 Amps		<b>250 VAC</b> <b>0</b> = 0.075 mA <b>1</b> = 0.01 mA <b>2</b> = 0.20 mA <b>3</b> = 0.35 mA <b>4</b> = 0.10 mA <b>5</b> = 0.50 mA <b>6</b> = 0.60 mA <b>7</b> = 0.70 mA <b>8</b> = 1.00 mA <b>9</b> = 3.00 mA		<b>125VAC</b> <b>0</b> = 0.035 mA <b>1</b> = 0.005 mA <b>3</b> = 0.35 mA <b>4</b> = 0.05 mA <b>5</b> = 0.50 mA <b>6</b> = 0.60 mA <b>7</b> = 0.70 mA <b>8</b> = 1.00 mA <b>9</b> = 3.00 mA	<b>0</b> = none <b>1</b> = 0.01 $\mu$ F <b>2</b> = 0.022 $\mu$ F <b>3</b> = 0.033 $\mu$ F <b>4</b> = 0.047 $\mu$ F <b>5</b> = 0.050 $\mu$ F <b>6</b> = 0.068 $\mu$ F <b>01</b> = 2 x 0.01 $\mu$ F <b>02</b> = 0.10 $\mu$ F & 0.22 $\mu$ F <b>04</b> = 2 x 0.22 $\mu$ F <b>06</b> = 2 x 0.4 $\mu$ F & 0.22 $\mu$ F <b>10</b> = 0.15 $\mu$ F <b>11</b> = 0.10 $\mu$ F <b>12</b> = 0.22 $\mu$ F <b>13</b> = 0.33 $\mu$ F <b>14</b> = 0.47 $\mu$ F <b>16</b> = 0.22 $\mu$ F & 2 x 0.33 $\mu$ F <b>21</b> = 1.00 $\mu$ F

\* Note: Not all series offer the product style, rating and leakage current. See specific part number tables for each product line

# Single Line Feed-Through Power Filters

API Technologies' Spectrum Control brand of standard and custom feed-through product line is available in a wide range of AC/DC current and voltage rating and addresses EMI filter needs for high current power applications. Circuit styles of Pi and C are included in the series with maximum current rating to 500 A and capacitance values to 4.7µF. A comprehensive range of AC and DC feed-through filters can achieve performance from 100 KHz to 10 GHz.

This product is ideal for applications within telecommunications, industrial, medical, avionic and military equipment including cellular base station, industrial processing, secure communications, defense systems and robotics where high current switching may occur. These components also offer a compact economic solution for any type of EMI issues.



## Features

- Low cost EMI solution
- Effective EMI performance from 100 kHz through 1.0 GHz
- Designed for bulkhead mounting, proper installation with a low impedance path from the mounting surface to case recommended for optimum performance
- Suitable for 0 - 400 Hz applications
- External discharge resistor recommended in application
- Operating temperature range: -40°C to +85°C without derating
- Can be used in both indoor and outdoor applications
- Excellent filtering in compact package
- Current ratings to 300 A
- Custom assemblies available upon request
- AC and DC models with Class Y4 caps
- C and Pi Configurations
- Bolt-in style with D-shaped bushing for easy installation
- UL approved and SEMKO approvals pending

## SLFT Part Numbering System

Example: **52F226-041-63**

Represents a DC feed-through capacitor with a very high capacitance (470 nF) 63 A current rating.

EMI Power Filters

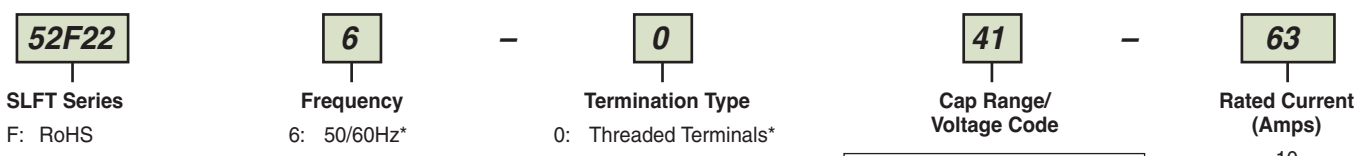

\* Indicates agency approved option

DC Series	
11:	10nF-100nF, DC FT
21:	47nF-470nF, DC FT
31:	100nF-1,000nF, DC FT
41:	470nF-4,700nF, DC FT
20:	10nF-470nF, DC Pi
29:	100nF-4,700nF, DC Pi
AC Series	
16:	2.2nF-100nF, AC FT
26:	4.7nF-220nF, AC FT
36:	47nF-4,700nF, AC FT
46:	100nF-1,000nF, AC FT
37:	4.7nF-100nF, AC FT
19:	10nF-470nF, AC FT

10  
16  
32  
63  
100  
200  
250  
300



## Commercial-Off-The-Shelf (COTS) Filters

API Technologies' Spectrum Control brand now offers COTS single line feed-through EMI filters that are the commercial equivalent to M15733-PRF/72, M15733-PRF/73 and M15733-PRF/74. These reliable AC and DC high performance filters provide an excellent source of filtering in a compact package and are well suited for the military and aerospace industries. They filter up to 500 A with an attenuation of 40 to 90 dB from 1 MHz to 1 GHz and voltage rating of 130 VDC to 250 VAC. Please reference API mechanical drawing.



### Dimensions

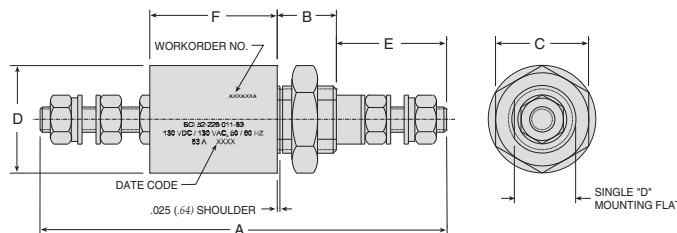

MIL part M15733/	p/n	A ±0.100	B ±0.032	C ±0.010	D ±0.010	E ±0.100	F Max	Mounting Flat ±0.015
72-0034	5004-7053-100-A	6.750	0.375	0.930	1.500	0.750	4.875	0.656
72-0046	5004-7053-100-A	6.750	0.375	0.930	1.500	0.750	4.875	0.656
72-0043	5004-7053-100-A	6.750	0.375	0.930	1.500	0.750	4.875	0.656
72-0049	5004-7059-100-A	7.250	0.375	0.930	2.000	0.750	5.375	0.656
72-0053	5004-7065-100-A	8.781	0.531	1.625	2.250	1.000	6.250	1.046
73-0034	5004-7058-125-A	7.250	0.375	0.930	2.000	0.750	5.375	0.656
73-0043	5004-7058-125-A	7.250	0.375	0.930	2.000	0.750	5.375	0.656
73-0046	5004-7052-125-A	6.750	0.375	0.930	1.500	0.750	4.875	0.656
73-0049	5004-7058-125-A	7.250	0.375	0.930	2.000	0.750	5.375	0.656
73-0051	5004-7059-250-A	7.250	0.375	0.930	2.000	0.750	5.375	0.656
73-0053	5004-7064-125-A	8.781	0.531	1.625	2.250	1.000	6.250	1.046
74-0030	5004-7041-250-A	4.750	0.310	0.616	1.000	0.600	3.400	0.437
74-0036	5004-7047-250-A	6.500	0.310	0.616	1.000	0.750	4.750	0.473
74-0042	5004-7053-250-A	6.750	0.375	0.930	1.500	0.750	4.875	0.656
74-0045	5004-7059-250-A	7.250	0.375	0.930	2.000	0.750	5.375	0.656

## Shielded Filters

API has developed a new power filter product line which provides MRI/RF shielding solutions for medical, commercial and government applications. Offers 100 dB insertion loss per MIL-STD 220 from 14 KHz to 10 GHZ.

### Shielded Room Filters

P/N Series	Configuration*	Description
52-1490	1 x 5	1 x 5 A, 277 VAC
	1 x 30	1 x 30 A, 277 VAC
	1 x 100	1 x 100 A, 277 VAC
	1 x 150	1 x 150 A, 277 VAC
	1 x 200	1 x 200 A, 277 VAC
	1 x 225	1 x 225 A, 277 VAC
	2 x 0.5	Speaker Filter
	2 x 1 ALRM	Fire Alarm Filter
	2 x 5	2 x 5 A, 277 VAC
	2 x 20	2 x 20 A, 277 VAC
	2 x 30	2 x 30 A, 277 VAC
	2 x 50	2 x 50 A, 277 VAC
	2 x 60	2 x 60 A, 277 VAC

\* Add to P/N series (eg. 52-1490-1x5)

Options are available with or without discharge light "L" at the end of the part (52-1490-1x5L). Custom configurations are available. Consult factory.



# Military/Aerospace Multisection Filters

API Technologies' Spectrum Control brand will address virtually any requirement for a military/custom power product. Our engineering expertise and vertical integrations reduce your speed to market as well as saves you money. Our electromagnetic compatibility expertise in the tempest arena can help you meet MIL-F-15733 and MIL-STD 461 standard requirements.

## Features

- High common and differential mode attenuation
- Standard designs up to 400 Amps
- Excellent insertion loss characteristics up to 10 GHz
- Voltage rating 115-250VAC and 400VDC up to 400 Hz
- Available to meet TEMPEST and FCC requirements
- Custom designs for application-specific requirements

## Test Specifications

The high performance power line filters shown on pages 62 and 63 are designed to meet the following criteria.

The information shown can be used as a basis for filter specifications. (Contact factory for additional details).



## Applications

- Military
- Commercial and military/aerospace
- Secured communications
- Switching power supplies
- Data processing equipment
- Ruggedized computers
- Radar
- Electronic warfare
- Ground/air weapon systems
- Satellites
- Ship board systems
- Land based vehicles
- Fixed and mobile control stations

EMI Power Filters

Test Group	Order of Test	Examination or Test	Test Method (Per MIL-STD-202)	Post Test Requirements
IIA	1	Voltage Drop	Paragraph 4.6.8 of MIL-F-15733	Three percent of rated voltage max.
	2	Leakage Current	UL 1283	Per applicable specification
	3	Temperature Rise	MIL-F-15733 Paragraph 4.6.4	25°C max.
	4	Terminal Strength	Method 211, Condition A	No evidence of loosening or rupture. 5 lb. applied force. Line Cords: 35 Lbs.
IIB	1	Shock, Medium Impact	Method 213, Condition G	Must pass DWV and Insertion Loss
	2	Vibration, High Frequency	Method 204, Condition A	Monitor for shorts or open
	3	Thermal Shock	Method 107, Test Condition A	Pass 90% DWV IR to be 30% of initial
	4	Humidity	Method 107, Condition B, except temperature equals 25°C	Pass 90% DWV IR to be 30% of initial
III	1	Life	Method 108, Condition D 1.2 x Rated AC voltage at max. operating temp. or 1.4 x DC voltage	Pass 90% DWV insulation resistance to be 30% of initial.

# Military/Aerospace Multisection Filters

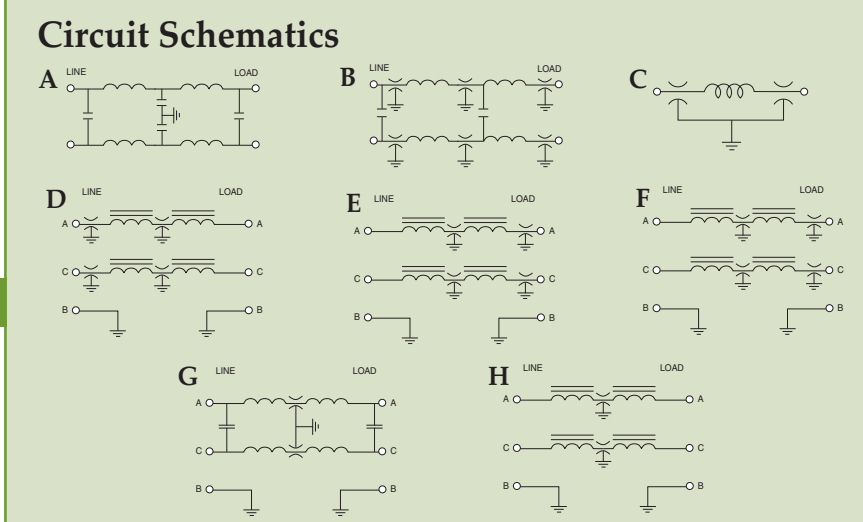

## Mechanical Dimensions

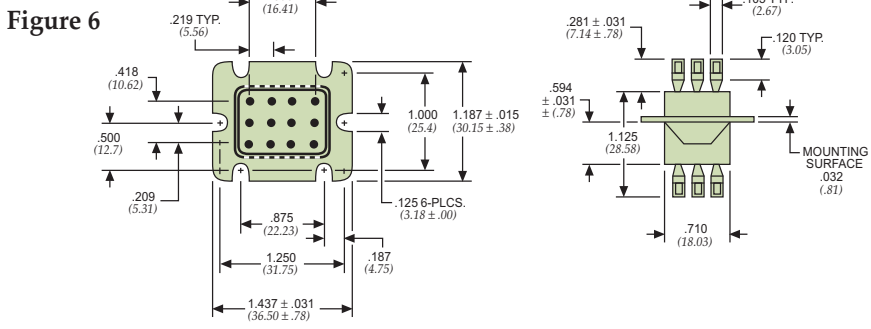
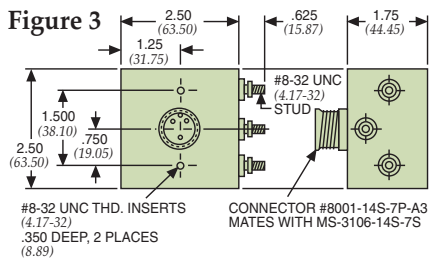
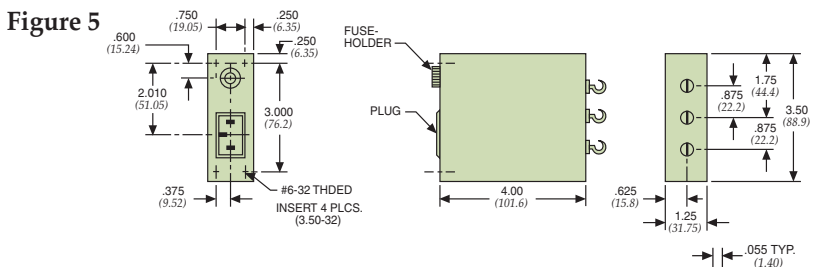
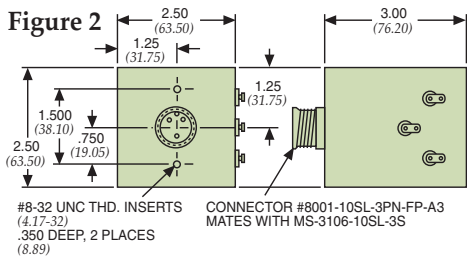
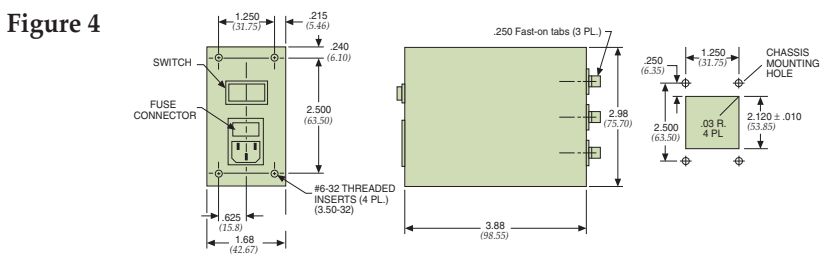
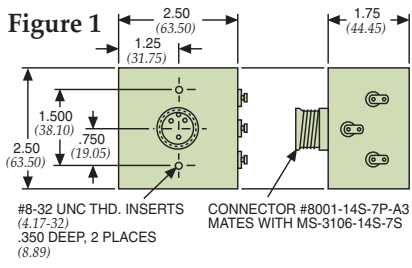

Model	Current Rating	Voltage Rating	Insertion Loss Min. (db)							DCR max. (ohms)	Leakage Current (max.)	Figures	Current Schematic
			50 KHz	150 KHz	300 KHz	1 M	10 M	100 M	1 GHz				
52-378-001	3 Amps	240VAC 60 Hz Line to Line	30	60	70	80	80	70	70	.30	50 mA	1	D
52-378-005	3 Amps	240VAC 60 Hz Line to Line	40	70	80	80	80	70	60	.30	50 mA	1	E
52-523-002	5 Amps	120/240VAC 60 Hz	—	55	60	80	80	70	60	.25	1 mA	5	B
52-378-002	5 Amps	240VAC 60 Hz Line to Line	34	64	70	80	80	70	70	.20	50 mA	1	D
52-378-004	5 Amps	240VAC 60 Hz Line to Line	24	64	70	80	80	70	70	.20	50 mA	1	E
52-387-012	5 Amps	240VAC 60 Hz Line to Line	34	64	70	80	80	70	70	.20	5 mA	2	G
52-600-001	5 Amps	120/240VAC 60 Hz	33	65	80	80	80	80	60	.20	1 mA	4	A
52-387-010	10 Amps	240VAC 60 Hz Line to Line	24	60	70	80	80	70	70	.20	50 mA	2	F
52-600-002	10 Amps	120/240VAC 60 Hz	—	50	70	80	80	70	60	.10	1 mA	4	A
1212-0502	10 Amps	350VDC 240VAC 60 Hz	—	—	—	—	20	65	70	.01	1 mA	6	C
52-409-001	14 Amps	240VAC 60 Hz Line to Line	14	30	45	80	80	70	60	.04	50 mA	3	H



# EMI Power Filter Solutions

## Custom Application-Specific Designs

Rarely does a 100% off-the-shelf power filter completely satisfy the mechanical, electrical and power requirements and constraints of a sophisticated OEM design. Yet for many, the term custom is intimidating, implying long lead times and higher costs. At API Technologies, we are focused on providing a complete solution that takes all factors into consideration. Whether modifying an existing power filter design, working from a “clean sheet” approach, or integrating various technologies into a subassembly, the resulting custom solution will be a API Technologies’ Spectrum Control brand product tailored to your project’s design, logistic and budgetary requirements.

## Application - Specific Options

- EMI filtering
- Power distribution
- Transient protection
- Indicator lights
- Circuit breaker protection
- Leads or studs
- Voltage cut-off
- Agency approvals
- Reverse polarity

## EMI Testing...Finding the Problem

Integral to finding a solution to an EMC problem is the ability to test for compliance. We conduct a wide range of EMC and environmental tests to help us identify potential problems and recommend design solutions. Our extensive in-house test capabilities allow for a faster turnaround of your complete design solution and lower total cost.

- In-house anechoic chamber and shielded room
- Baseline of device under ambient-free anechoic chamber
- NARTE certified engineering staff
- Highly accurate computer controlled instrumentation accumulates and presents data in multiple formats
- Testing for MIL standards, European emissions and immunity regulations, and FCC Part 15 (market specific detail on following pages).

We can “clean up” your system by creating an easy-to-install assembly that contains all the components and filtering solutions in one compact package.

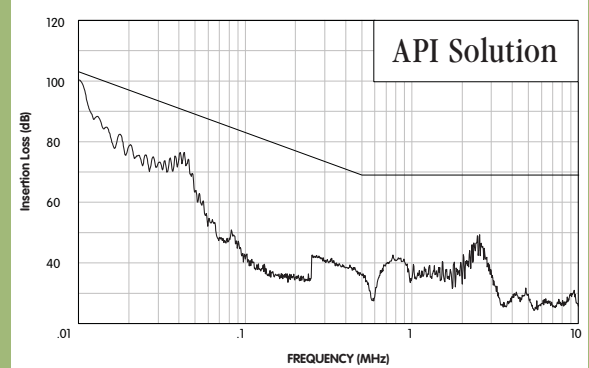
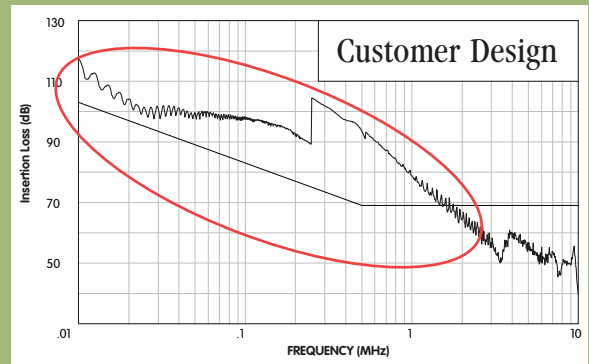
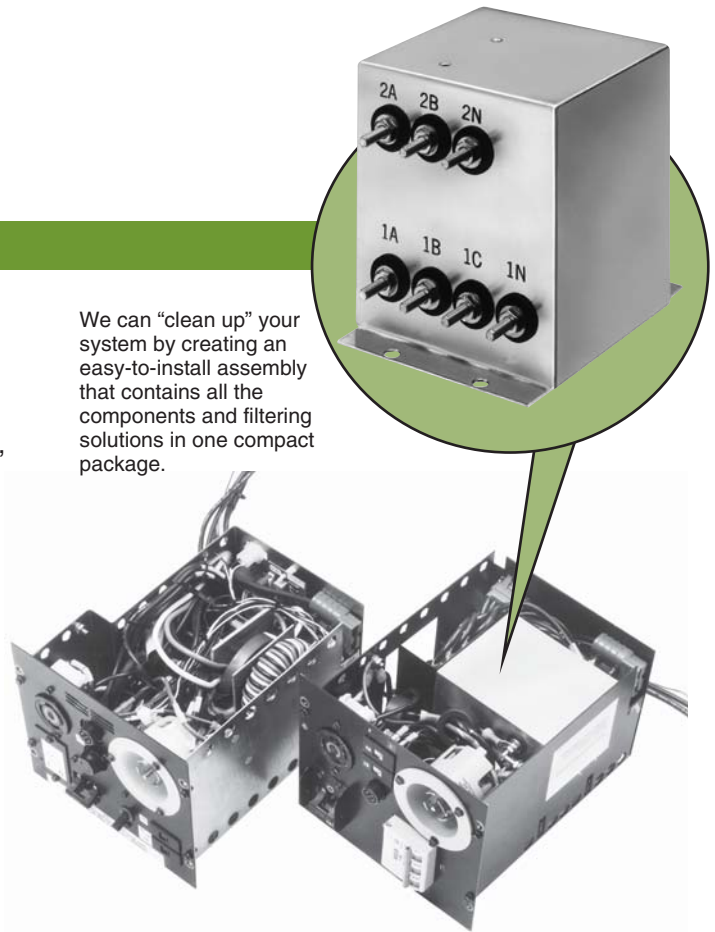

# EMI Power Filter Solutions

## Military and Aerospace

API Technologies has a long history of partnering with leading suppliers of the defense industry. Our ability to find solutions to suppress or eliminate electromagnetic interference (EMI) allows us to provide the high reliability filters required for military and aerospace applications. API's Spectrum Control brand can design your custom filter with a unique mechanical package for those unusual or tight fitting spaces, higher performance filtering and the voltage rating you need to address all of your AC and DC power issues.

## Communications

API's Spectrum Control line of power filter solutions can create an agency-approved product that will filter and condition the power to your communications infrastructure equipment, as well as eliminate emissions that can contaminate your distributed AC and DC power. Our custom power filters will incorporate all the components and the filtering in one complete package to save you space, time and money. And as a vertically integrated supplier, API offers global low cost manufacturing which allows us to produce fast prototypes and a quicker time to market.

## Medical

Our many years of experience in providing EMI/RFI solutions has given us the know-how to design products to meet the specific constraints and requirements of the medical industry. Much of the medical equipment used today requires complete suppression of any and all EMI, as well as low-leakage, nonmagnetic properties to prevent negatively affecting surrounding equipment. We will design and build a high reliability, high performance custom power filter to meet your system and all EN requirements.

## Industrial

At API, we do everything from package design and metalworking to EMI filtering to EMC testing, which means a lower cost for you. Our engineers will design and build a custom power filter that will satisfy global EMC regulations, improve speed-to-market times, overcome space constraints and withstand harsh environmental conditions. Our plug-and-play designs cover a range of industrial and instrumentation applications that will address any of your power filtering needs with current ratings as high as 500 Amps.

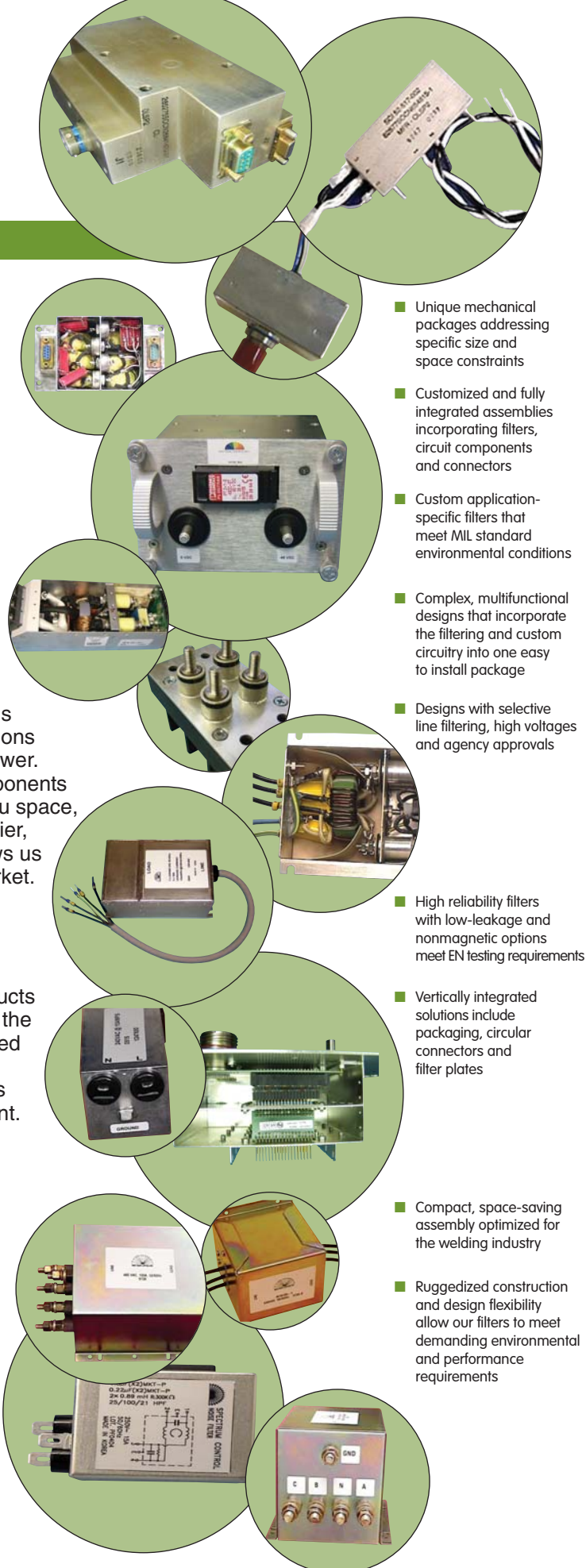

- Unique mechanical packages addressing specific size and space constraints
- Customized and fully integrated assemblies incorporating filters, circuit components and connectors
- Custom application-specific filters that meet MIL standard environmental conditions
- Complex, multifunctional designs that incorporate the filtering and custom circuitry into one easy to install package
- Designs with selective line filtering, high voltages and agency approvals
- High reliability filters with low-leakage and nonmagnetic options meet EN testing requirements
- Vertically integrated solutions include package, circular connectors and filter plates
- Compact, space-saving assembly optimized for the welding industry
- Ruggedized construction and design flexibility allow our filters to meet demanding environmental and performance requirements

# Magnetics

*we offer a variety of transformers, inductors, choke, coils and custom solutions to meet your magnetics needs*



## Custom Magnetic Solutions

We offer extensive design and manufacturing capabilities, including more than two dozen magnetic core materials and winding wire from 6 to 45 gauge with many coatings, leads and terminations. We produce toroids ranging in size from 0.5" to 18" in diameter with up to 4,000 turns and accuracy to +/- 1 turn, and a wide variety of encapsulation and laminate options. Below are some of the critical design criteria we will work with your engineering team to address.

**Electrical Characteristics** - Identifying the circuit function/application and/or specifying electrical requirements such as amperage, voltage, inductance, frequency response, leakage, and noise reduction often determines selection of materials and components.

**Mechanical Constraints** - Restrictions on maximum height and available board area and mounting style (surface mount or through-hole) set physical parameters that often are difficult to change. Mechanical size restrictions can strongly affect component temperature rise.

**Environmental Conditions** - Maximum/minimum operating temperatures and allowed surface and/or internal temperatures of components, including UL compliance, as well as conditions such as air flow, sealing of container, high shock, and vibration will influence material selection and design.

**Regulating Requirements** - Considerations include safety standards to be met (eg. IEC/UL 60950-1, UL61010-1, UL 1585 etc), listing of the unit with a regulatory agency such as UL, CSA or VDE and requirements for UL thermal insulation system marking.

**Qualification Conditions** - Identify the qualification process required prior to approval, be it customer standards, or Hi-Rel standards such as MIL-PRF-27 or MIL-STD-981 and whether formal testing or the ability to demonstrate compliance by design is necessary.

Our magnetics group combines the people, products and technologies of several brands, including Filtran, Keytronics and RTI Electronics, in order to satisfy your magnetics requirements. API Technologies is a key supplier to many of the world's leading OEMs, serving the military, aerospace, medical, telecom, transport, RF and industrial/test measurement markets.

## Quality Construction

API's commitment to quality begins with a rigorous raw material selection and inspection process and continues through highly trained operators utilizing state-of-the-art equipment. The end result are the highest quality magnetics consistently manufactured to meet some of the industry's most stringent requirements including many MIL, ANSI and ISO certifications.



# Magnetics

## Current Transformers

### High Frequency Current Transformers

- 20 kHz-100 kHz operating frequency
- Available totally encapsulated, with or without wound primary turns and loading resistor
- Built to UL, MIL, VDE, CE specs, EMRL current transformers meet UL1244
- Ideal for ammeters, wattmeters, relays and cross current compensation



### Load Detector Current Sensors

- Innovative Snap-On load detectors mount on pre-wired systems without disrupting existing connections
- Broad frequency response of 30Hz to 15 kHz
- Measure currents up to 40 Amps RMS continuous and 120 Amps intermittent
- Excellent for economical energy management and automation control

## Power Inductors/Chokes

- Precision wound heavy-duty toroidal inductors
- Stores energy as a magnetic field, can delay and reshape alternating current
- Up to 100 amps, standard
- Semi or full epoxy molded, horizontal and vertical mounting
- Lighting dimmers – low wattage residential to higher wattage commercial, motor controls, SCR controls and line filters

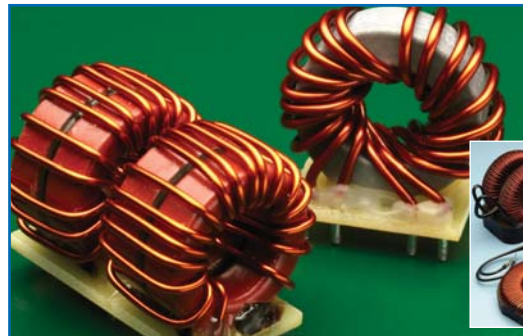

## Switch Mode Power Supply Inductors

- Filter inductors, toroidal current sense transformers and high frequency inverter transformers
- Performance verified in 25kHz power supply
- 10 to 1,000 watts with low power losses
- Switching frequencies from 5 to 100 kHz
- Open winding, semi-encapsulated and encapsulated construction
- Custom designs up to 200 Amps

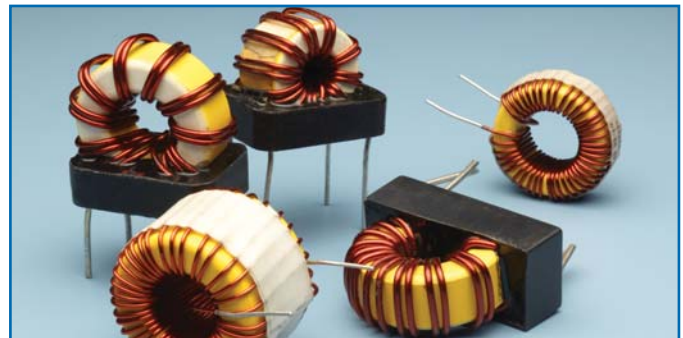

## Lighting Chokes & Inductor/Filters

- Precision wound heavy-duty toroidal inductors
- Rugged design
- 120 volt models from 12.5 to 100 Amps
- 240 volt models from 8.3 to 60 Amps
- High quality noise rejection filter
- Ideal for lighting dimmers, EMI/RFI filters, PWM and PM circuits primarily for motor controls, UPS Systems, differential mode line filters



## Magnetics

### Toroidal Power Transformers

- 50/60HZ, 5-15,000V Power Transformers (Europe ER series)
- 60 Hz 120V Power Transformers (U.S. FR series)
- 400Hz 115-230V Power transformer (Military DR series)
- Convert power-level voltages from one level or phase configuration
- Lower magnetic leakage, lower electrical noise and mechanical hum
- Excellent as isolation step-down and high voltage step-up transformers, autotransformer, ferroresonant transformer and smoothing inductor

### Laminate Power Transformers

- Value ranges from 3 VA to 100,000 VA
- Transform line voltage to any other voltage
- Apps include audio power conditioning, low-wattage indoor and outdoor lighting solutions, military and commercial UPS systems, power supplies, mono crystalline and crystalline solar processing

### Modem & Module Transformers

- Broadband and voiceband transformers used for datacom and telecom applications
- xDSL, T1/E1, T3/DS3/E3/STS-1, ISDN interface modules
- ADSL / POTS splitter modules
- Impedance and line matching transformers

### Air Coils

- Custom and build-to-print air coils for RF power, filter and sensing applications
- Made with specialized custom tooling to meet customer dimensional and electrical requirements

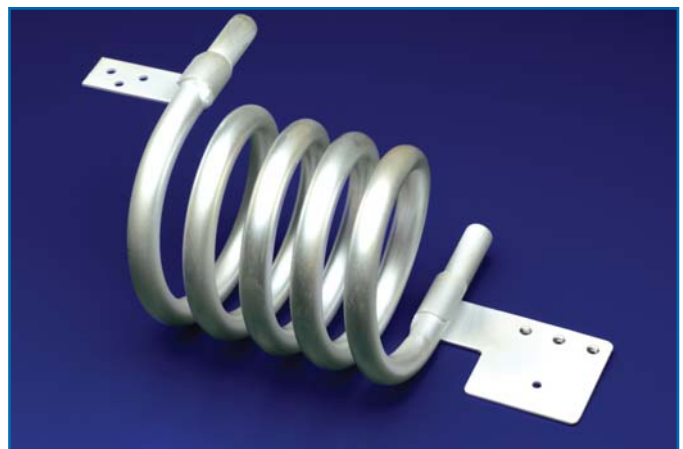
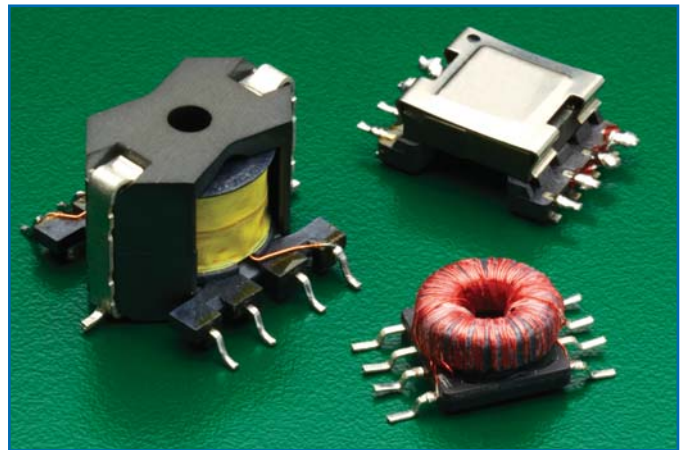
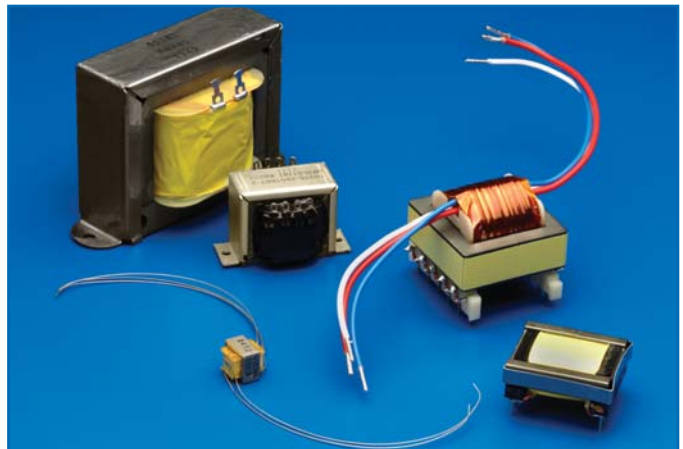
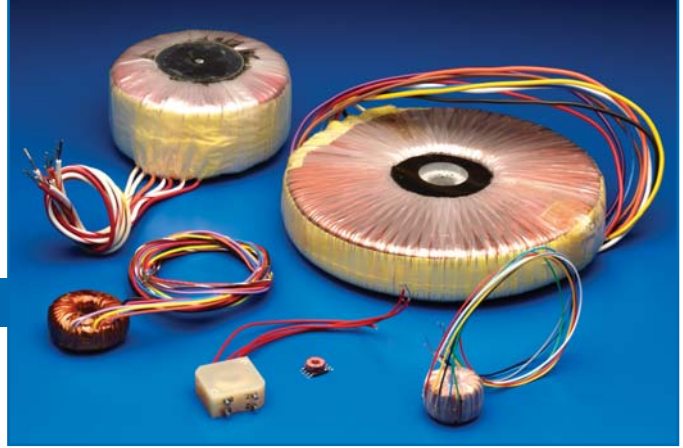



# API Technologies Corp.

## RF/Microwave & Microelectronics

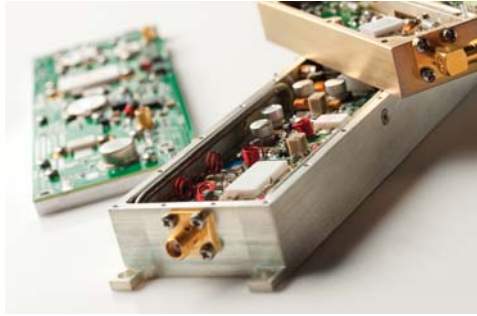

### Featured products

- Filters
- Amplifiers & Power Amplifiers
- Integrated Microwave Assemblies
- RF Passives & Active Components
- Microelectronics
- SAW/BAW Modules and Assemblies
- High Temperature Electronics
- AESA Radar Solutions

### Featured Brands

- Spectrum Microwave
- API Inmet
- API Weinschel
- CMT Filters

[micro.apitech.com](http://micro.apitech.com)

## Electromagnetic Integrated Solutions



### Featured products

- Coaxial Filters & Interconnects
- Specialty Connectors
- Power Filters
- Ceramic Capacitors
- Magnetics, Inductors, Transformers
- Custom Cables & Harnessing

### Featured Brands

- Spectrum Control
- Filtran
- Keytronics
- RTI Electronics

[eis.apitech.com](http://eis.apitech.com)

## Power Solutions



### Featured products

- Rugged & Specialty Power Control & Distribution
- Power Supplies
- Smart PDUs
- Rack Mount Power Strips
- Custom Military PDUs

### Featured Brands

- Spectrum Power
- Running Springs Audio

[power.apitech.com](http://power.apitech.com)

## Secure Systems & Information Assurance



### Featured products

- Secure Communications
- Rugged & Bespoke IT Systems
- Secure Access Solutions
- Encryption Solutions
- SST/Emcon-Brand TEMPEST Solutions

### Featured Brands

- Emcon®
- ION Networks™
- SST™

[ssia.apitech.com](http://ssia.apitech.com)

## Electronics Manufacturing Services



### Featured products

- Build to Print
- CCA/PCB Assembly
- Box Build & Final Assembly
- Test & Inspection

### Featured Brands

- SenDEC Corporation

[ems.apitech.com](http://ems.apitech.com)



- EMI Filters
- Filtered Interconnects
- Ceramic Capacitors
- Power Filters
- Specialty Connectors
- Magnetics

## Sales Offices

### NORTH AMERICA

8061 Avonia Road  
Fairview, Pennsylvania 16415  
Phone: 814-474-1571  
Fax: 814-474-3110

### EUROPE

Spectrum Control GmbH  
Hansastraße 6  
91126 Schwabach, Germany  
Phone: (49)-9122-795-0  
Fax: (49)-9122-795-58

### CHINA

Spectrum Control Limited  
2nd Industrial Area  
Ling Tou Industrial Road  
Qiad Tou Town, Dong Guan City  
Guang Dong Province 523530  
Peoples Republic of China  
Phone: (011)-86-769-8343-7761  
Fax: (011)-86-769-8343-7760

ISO 9001:2008  
AS 9100  
RoHS  
COMPLIANT



## About API Technologies

API Technologies Corp. is a trusted provider of RF/microwave, microelectronics, and security solutions for critical and high-reliability applications. The company designs, develops and manufactures electronic components, modules, systems and products for technically demanding defense, commercial/industrial and aerospace applications. API Technologies' customers include many leading Fortune 500 companies, as well as a majority of NATO governments. While API was founded in 1981, our heritage brands have served the demanding, hi-rel marketplace for more than 60 years.

**RF/Microwave & Microelectronics**

**Electromagnetic Integrated Solutions**

**Power Solutions**

**Secure Systems & Information Assurance**

**Electronics Manufacturing Services**