

**BIDIRECTIONAL THYRISTOR OVERVOLTAGE PROTECTORS**



**TISP4xxxL3BJ Overvoltage Protector Series**

**MODEM Protection against:**  
 - TIA/EIA-IS-968 Type A & B surge (formally FCC Part 68)  
 - UL 60950, Clause 6. power cross  
 - CSA 22.2 No. 60950, Clause 6. power cross

Ring-Tip Protection .....TISP4350L3BJ

Electronics Protection.....TISP4070L3BJ

**Ion-Implanted Breakdown Region  
 Precise and Stable Voltage  
 Low Voltage Overshoot under Surge**

Device	V <sub>DRM</sub> V	V <sub>(BO)</sub> V
'4070	58	70
'4350	275	350

**SMBJ Package (Top View)**

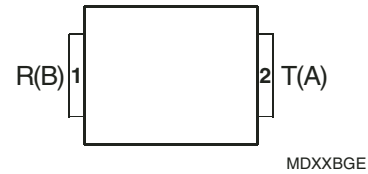

**Device Symbol**

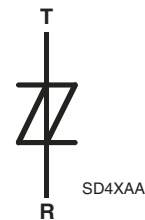

Terminals T and R correspond to the alternative line designators of A and B

..... **UL Recognized Components**

**Rated for '60950 and '968 Wave Shapes**

Surge Type	Standard	Wave Shape	I <sub>TSP</sub> A
A	TIA/EIA-IS-968 (FCC Part 68)	10/160 μs	50
		10/560 μs	30
B	TIA/EIA-IS-968 (FCC Part 68) UL 60950 / ITU-T K.21	9/720 μs 10/700 μs	40

**Description**

These devices are designed to limit overvoltages on the telephone line. Overvoltages are normally caused by a.c. power system or lightning flash disturbances which are induced or conducted on to the telephone line. A single device provides 2-point protection and is typically used for the protection of 2-wire telecommunication equipment (e.g. between the Ring and Tip wires for telephones and modems). Combinations of devices can be used for multi-point protection (e.g. 3-point protection between Ring, Tip and Ground).

The protector consists of a symmetrical voltage-triggered bidirectional thyristor. Overvoltages are initially clipped by breakdown clamping until the voltage rises to the breakover level, which causes the device to crowbar into a low-voltage on state. This low-voltage on state causes the current resulting from the overvoltage to be safely diverted through the device. The high crowbar holding current prevents d.c. latchup as the diverted current subsides. These protectors are guaranteed to voltage limit and withstand the listed lightning surges in both polarities.

After a Type A surge the equipment can be non-operational or operational. An operational pass requires the two high current Type A surges (200 A, 10/160, and 100A, 10/560), to be reduced to within the TISP4xxxL3BJ ratings (50 A, 10/160 and 30 A, 10/560).

**How To Order**

Device	Package	Carrier	For Standard Termination Finish Order As	For Lead Free Termination Finish Order As
TISP4xxxL3BJ	BJ (J-Bend DO-214AA/SMB)	Embossed Tape Reeled	TISP4xxxL3BJR	TISP4xxxL3BJR-S

Insert xxx value corresponding to protection voltages of 070 and 350

After a Type B surge, the equipment must be operational. As the TISP4xxxL3BJ has a current rating of 40 A, it will survive both Type B surges, metallic (25 A, 9/720) and longitudinal (37.5 A, 9/720), giving an operational pass to Type B surges.

\*RoHS Directive 2002/95/EC Jan 27 2003 including Annex  
 AUGUST 1999 - REVISED FEBRUARY 2005  
 Specifications are subject to change without notice.  
 Customers should verify actual device performance in their specific applications.

# TISP4xxxL3BJ Overvoltage Protector Series

**BOURNS®**

## Description (continued)

For metallic protection, the TISP4350L3BJ is connected between the Ring and Tip conductors. For longitudinal protection, two TISP4350L3BJ protectors are used; one between the Ring conductor to ground and the other between the Tip conductor to ground. The B type ringer has voltages of 56.5 V d.c. and up to 150 V r.m.s. a.c., giving a peak voltage of 269 V. The TISP4350L3BJ will not clip the B type ringing voltage as it has a high impedance up to 275 V.

The TISP4070L3BJ should be connected after the hook switch to protect the following electronics. As the TISP4070L3BJ has a high impedance up to 58 V, it will switch off after a surge and not be triggered by the normal exchange battery voltage.

These low (L) current protection devices are in a plastic package SMBJ (JEDEC DO-214AA with J-bend leads) and supplied in embossed tape reel pack. For alternative voltage and holding current values, consult the factory. For higher rated impulse currents in the SMB package, the 100 A 10/1000 TISP4xxxH3BJ series is available.

## Absolute Maximum Ratings, $T_A = 25\text{ }^\circ\text{C}$ (Unless Otherwise Noted)

Rating	Symbol	Value	Unit
Repetitive peak off-state voltage	<sup>4070</sup> <sub>4350</sub> $V_{DRM}$	$\pm 58$ $\pm 275$	V
Non-repetitive peak on-state pulse current (see Notes 1, and 2) 10/160 $\mu\text{s}$ (FCC Part 68, 10/160 $\mu\text{s}$ voltage wave shape, Type A) 5/310 $\mu\text{s}$ (ITU-T K.21, 10/700 $\mu\text{s}$ voltage wave shape) 5/320 $\mu\text{s}$ (FCC Part 68, 9/720 $\mu\text{s}$ voltage wave shape, Type B) 10/560 $\mu\text{s}$ (FCC Part 68, 10/560 $\mu\text{s}$ voltage wave shape, Type A)	$I_{TSP}$	50 40 40 30	A
Non-repetitive peak on-state current (see Notes 1, 2 and 3) 20 ms (50 Hz) full sine wave 16.7 ms (60 Hz) full sine wave 1000 s 50 Hz/60 Hz a.c.	$I_{TSM}$	12 13 2	A
Initial rate of rise of on-state current, Exponential current ramp, Maximum ramp value < 100 A	$di_T/dt$	120	A/ $\mu\text{s}$
Junction temperature	$T_J$	-40 to +150	$^\circ\text{C}$
Storage temperature range	$T_{stg}$	-65 to +150	$^\circ\text{C}$

- NOTES: 1. Initially the TISP4xxxL3BJ must be in thermal equilibrium with  $T_J = 25\text{ }^\circ\text{C}$ .  
2. The surge may be repeated after the TISP4xxxL3BJ returns to its initial conditions.  
3. EIA/JESD51-2 environment and EIA/JESD51-3 PCB with standard footprint dimensions connected with 5 A rated printed wiring track widths. Derate current values at  $-0.61\text{ } \%/^\circ\text{C}$  for ambient temperatures above  $25\text{ }^\circ\text{C}$ .

## Overload Ratings, $T_A = 25\text{ }^\circ\text{C}$ (Unless Otherwise Noted)

Rating	Symbol	Value	Unit
Peak overload on-state current, Type A impulse (see Note 4) 10/160 $\mu\text{s}$ 10/560 $\mu\text{s}$	$I_{T(OV)M}$	200 100	A
Peak overload on-state current, a.c. power cross tests UL 1950 (see Note 4)	$I_{T(OV)M}$	See Figure 2 for current versus time	A

- NOTE 4: These electrical stress levels may damage the TIS4xxxL3BJ silicon chip. After test, the pass criterion is either that the device is functional or, if it is faulty, that it has a short circuit fault mode. In the short circuit fault mode, the following equipment is protected as the device is a permanent short across the line. The equipment would be unprotected if an open circuit fault mode developed.

# TISP4xxxL3BJ Overvoltage Protector Series



## Electrical Characteristics for the R and T Terminals, $T_A = 25\text{ °C}$ (Unless Otherwise Noted)

Parameter	Test Conditions	Min	Typ	Max	Unit	
$I_{DRM}$ Repetitive peak off-state current	$V_D = V_{DRM}$ $T_A = 25\text{ °C}$ $T_A = 85\text{ °C}$			$\pm 5$ $\pm 10$	$\mu A$	
$V_{(BO)}$ Breakover voltage	$dv/dt = \pm 250\text{ V/ms}$ , $R_{SOURCE} = 300\ \Omega$			$\pm 70$ $\pm 350$	V	
$V_{(BO)}$ Impulse breakover voltage	$dv/dt \leq \pm 1000\text{ V}/\mu s$ , Linear voltage ramp, Maximum ramp value = $\pm 500\text{ V}$ $di/dt = \pm 20\text{ A}/\mu s$ , Linear current ramp, Maximum ramp value = $\pm 10\text{ A}$			$\pm 78$ $\pm 359$	V	
$I_{(BO)}$ Breakover current	$dv/dt = \pm 250\text{ V/ms}$ , $R_{SOURCE} = 300\ \Omega$	$\pm 40$		$\pm 250$	mA	
$V_T$ On-state voltage	$I_T = \pm 5\text{ A}$ , $t_W = 100\ \mu s$			$\pm 3$	V	
$I_H$ Holding current	$I_T = \pm 5\text{ A}$ , $di/dt = -/+ 30\text{ mA/ms}$	$\pm 120$		$\pm 350$	mA	
$dv/dt$ Critical rate of rise of off-state voltage	Linear voltage ramp, Maximum ramp value $< 0.85V_{DRM}$	$\pm 5$			kV/ $\mu s$	
$I_D$ Off-state current	$V_D = \pm 50\text{ V}$ $T_A = 85\text{ °C}$			$\pm 10$	$\mu A$	
$C_{off}$ Off-state capacitance	$f = 100\text{ kHz}$ , $V_d = 1\text{ V rms}$ , $V_D = 0$ $V_D = 1\text{ V}$ $V_D = 5\text{ V}$ $f = 100\text{ kHz}$ , $V_d = 1\text{ V rms}$ , $V_D = 0$ $V_D = 1\text{ V}$ $V_D = 5\text{ V}$	$\pm 4070$   $\pm 4350$		40 38 31 26 24 20	50 48 39 33 30 25	pF

## Thermal Characteristics

Parameter	Test Conditions	Min	Typ	Max	Unit
$R_{\theta JA}$ Junction to free air thermal resistance	EIA/JESD51-3 PCB, $I_T = I_{TSM}(1000)$ , $T_A = 25\text{ °C}$ , (see Note 5)			115	$\text{°C /W}$
	265 mm x 210 mm populated line card, 4-layer PCB, $I_T = I_{TSM}(1000)$ , $T_A = 25\text{ °C}$		52		

NOTE 5: EIA/JESD51-2 environment and PCB has standard footprint dimensions connected with 5 A rated printed wiring track widths.

## Parameter Measurement Information

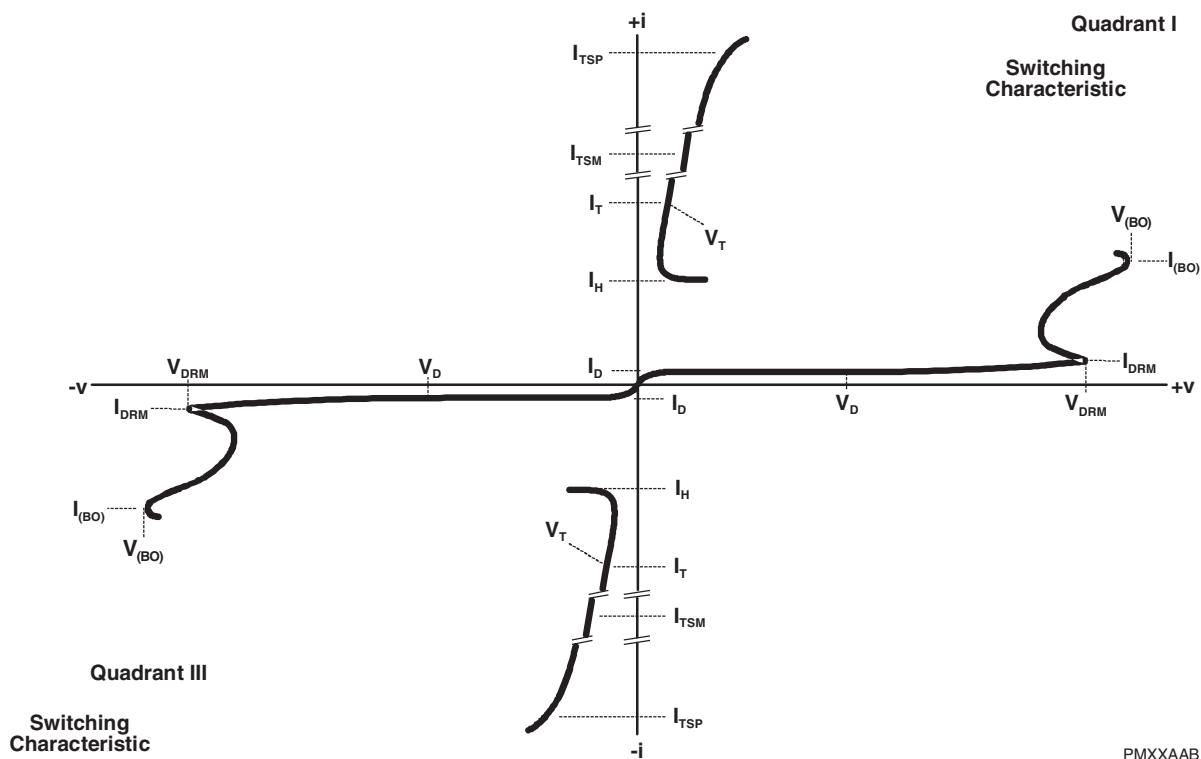

**Figure 1. Voltage-current Characteristic for T and R Terminals**  
**All Measurements are Referenced to the R Terminal**

## Thermal Information

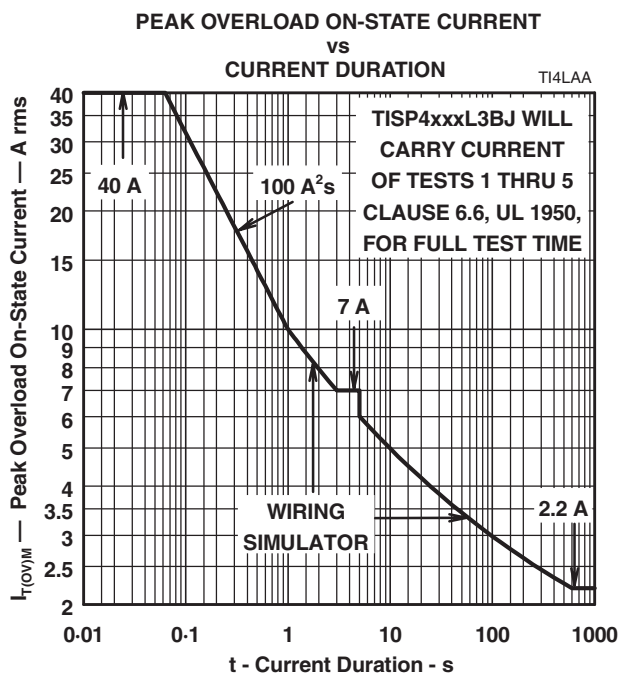

Figure 2. Peak Overload On-state Current against Duration

# TISP4xxxL3BJ Overvoltage Protector Series

**BOURNS®**

## APPLICATIONS INFORMATION

### FCC Part 68, ACTA, TIA and EIA

From 2001, the registrations for FCC equipment changed from the FCC to ACTA, Administrative Council for Terminal Attachments. For this function, ACTA needed to adopt a US National standard specifying terminal equipment requirements. The TIA, Telecommunications Industry Association, in conjunction with the EIA, Electronic Industries Alliance, created TIA/EIA-IS-968 for this purpose. The first issue of TIA/EIA-IS-968 is essentially a renumbered version of the FCC Part 68 requirement. Clause and figure changes are shown in the table.

Item	FCC Part 68	TIA/EIA-IS-968
Telephone Line Surge – Type A	Clause 68.302 (b)	Clause 4.2.2
Telephone Line Surge – Type B	Clause 68.302 (c)	Clause 4.2.3
Simplified Surge Generator	Fig. 68.302 (a)	Figure 4.1
Open Circuit voltage Wave shape	Fig. 68.302 (b)	Figure 4.2
Short Circuit Current Wave shape	Fig. 68.302 (c)	Figure 4.3

### TIA/EIA-IS-968 (FCC Part 68) Impulse Testing

To verify the withstand capability and safety of the equipment, standards require that the equipment is tested with various impulse wave forms. The table below shows values for the TIA/EIA-IS-968 and ITU-T recommendation K.21.

Standard	Test Condition V	Peak Voltage V	Voltage Wave Form $\mu$ s	Peak Current A	Current Wave Form $\mu$ s	Fictive Impedance $\Omega$	TISP4xxxL3 Rating A	Series Resistance $\Omega$
TIA/EIA-IS-968 (FCC Part 68)	Longitudinal	1500	10/160	200	10/160	7.5	50	2 x 24
	Metallic	800	10/560	100	10/560	8	30	19
	Longitudinal	1500	9/720 †	37.5	5/320 †	40	40	0
	Metallic	1000	9/720 †	25	5/320 †	40	40	0
ITU-T K.21 ‡ Basic Level	Transverse	1500	10/700	37.5	5/310	40	30	0
		4000		100				10
ITU-T K.21 ‡ Enhanced Level	Transverse	1500	10/700	37.5	5/310	40	30	0
		6000		125				10

† TIA/EIA-IS-968 terminology for the wave forms produced by the ITU-T recommendation K.21 10/700 impulse generator

‡ Values assume the TISP4xxxL3 is connected inter-conductor and a 400 V primary is used

If the impulse generator current exceeds the protector's current rating then a series resistance can be used to reduce the current to the protector's rated value to prevent possible failure. The required value of series resistance for a given wave form is given by the following calculations. First, the minimum total circuit impedance is found by dividing the impulse generator's peak voltage by the protector's rated current. The impulse generator's fictive impedance (generator's peak voltage divided by peak short circuit current) is then subtracted from the minimum total circuit impedance to give the required value of series resistance.

For the TIA/EIA-IS-968 10/560 wave form the following values result. The minimum total circuit impedance is  $800/30 = 26.7 \Omega$  and the generator's fictive impedance is  $800/100 = 8 \Omega$ . For an inter-conductor connected TISP4xxxL3, this gives a minimum series resistance value of  $26.7 - 8 = 18.7 \Omega$ . After allowing for tolerance, a  $20 \Omega \pm 5 \%$  resistor would be suitable. The 10/160 wave form only needs to be considered if the TISP4350L3 is connected from the conductor to ground. In this case, the conductor series resistance is  $24 \Omega \pm 5 \%$  per conductor.

### IEC 60950, UL 1950/60950, CSA C22.2 No. 950/60950 and EN 60950

These electrical safety standards for IT (Information Technology) equipment at the customer premise use the IEC (International Electrotechnical Commission) 60950 standard as the core document. The IEC 60950 covers fundamental safety criteria such as creepage and isolation. The connection to a telecommunication network voltage (TNV) is covered in clause 6.

Europe is harmonized by CENELEC (Comité Européen de Normalization Electro-technique) under EN 60950 (included in the Low Voltage Directive, CE mark). Up to the end of 2000, the US had UL (Underwriters Laboratories) 1950 and Canada CSA (Canadian Standards Authority) C22.2 No. 950. The US and Canadian standards include regional changes and additions to the IEC 60950. A major addition is the inclusion of clause 6.6, power cross withstand containing the flowchart Figure 18b and annex NAC covering testing. Remarks made for UL 1950 will generally be true for CSA 22.2 No. 950.

AUGUST 1999 - REVISED FEBRUARY 2005

Specifications are subject to change without notice.

Customers should verify actual device performance in their specific applications.

## APPLICATIONS INFORMATION

### IEC 60950, UL 1950/60950, CSA C22.2 No. 950/60950 and EN 60950 (continued)

In December 2000, UL released UL 60950, which will run concurrently with UL 1950 until 2003, after which submittals can only be made for UL 60950. The equivalent Canadian document is designated CSA C22.2 No. 60950. Changes and differences between UL 1950 and UL 60950 do not affect power cross testing nor evaluation criteria. Clause and figure numbering has changed between the standards and these changes are shown in the table. In this document, these two standards are being jointly referred to as UL 60950 and the clause and figure numbering referenced will be from UL 60950.

Item	UL 1950	UL 60950
Protection against overvoltage from power line crosses	Clause 6.6	Clause 6.4
Overvoltage flowchart	Figure 18b	Figure 6C

### UL 60950, Clause 6.4 – Power Cross

Figure 3 shows the criterion flow for UL 60950 power cross. (This is a modified version of UL6050, Figure 6C — Overvoltage flowchart). There are many routes for achieving a pass result. For discussion, each criterion has been given a letter reference. Brief details of any electrical testing is given as a criterion note. Test pass criteria are given in the bottom table of Figure 3.

## APPLICATIONS INFORMATION

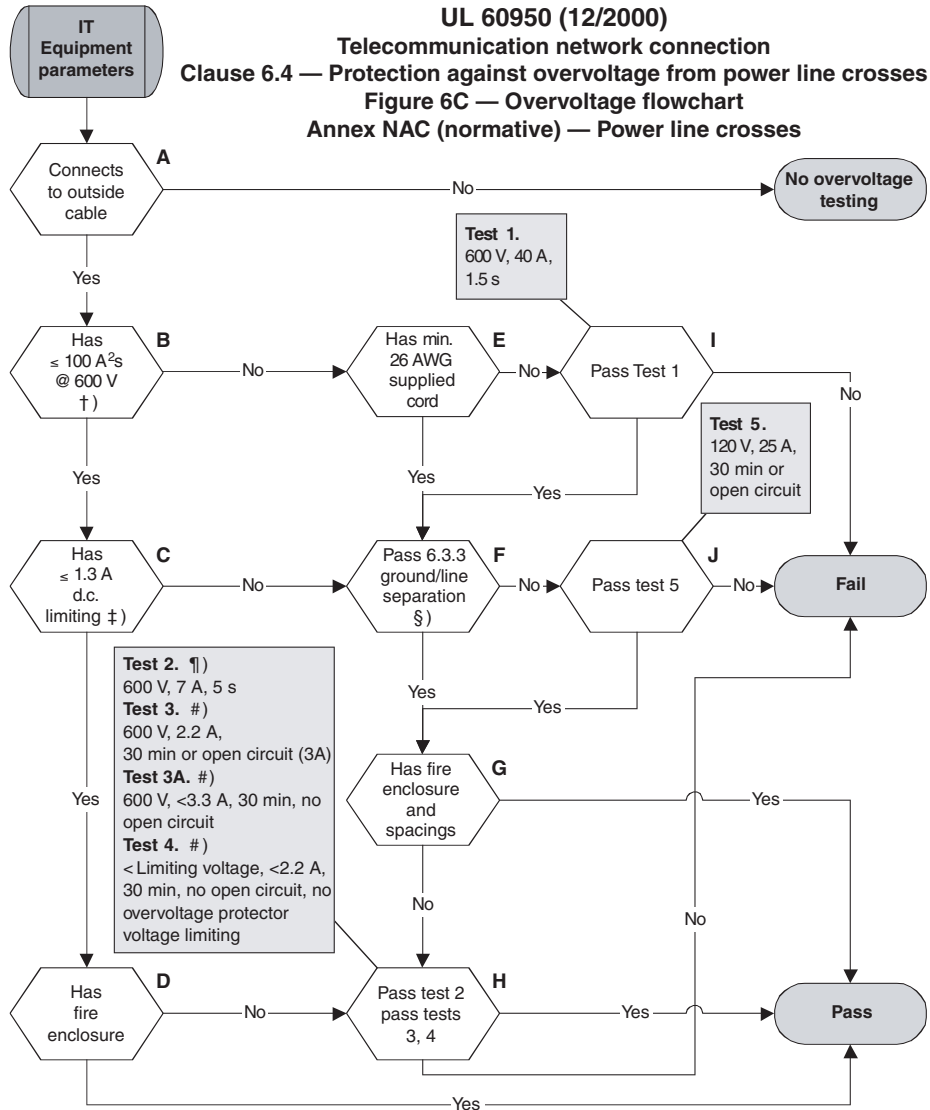

**NOTES**  
 †) Overcurrent protector  $I^2t$  must be lower than any other equipment element which carries the same current.  
 ‡) UL accepts that a fuse with a 1 A or less rating meets the 1.3 A criterion.  
 §) Pass for 120 V a.c. between telecommunication line and ground current < 10 mA.  
 ¶) Test 2 not required if the equipment d.c. breaking is 1.3 A or less, see comment ‡).  
 #) Tests 3 and 4 not required for equipment with less than 1000 m of outside cable.

Pass criteria	Test 1	Test 2	Test 3	Test 3A	Test 4	Test 5
No cheesecloth charring	✓	✓	✓	✓	✓	✓
Insulation OK	✓	✓	✓	✓	✓	✓
Wiring simulator (fuse) OK	✓					✓
$I^2t < 100 A^2s @ 600 V a.c.$	✓					

Users must verify requirements against latest issue of UL 60950  
 AIUL60950A

Figure 3. UL 60950 Power Cross Flow Chart



## APPLICATIONS INFORMATION

### Power Cross Pass Routes

This discussion covers typical modem flows.

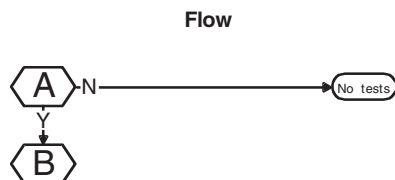

#### Box A

The criterion for box A is if the modem connects to an outside TNV line.

The majority of modems will be connected to an outside line, so the answer is yes. The *yes* path goes to box B.

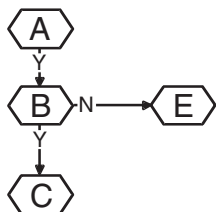

#### Box B

The criterion for box B is if the equipment has a limit of  $\leq 100 A^2s$  at 600 V rms for Test 1. Many interpret this as a fuse with  $I^2t \leq 100 A^2s$  and often miss the 600 V a.c. breaking requirement. However, the current loop is completed by the fuse and other equipment components. To ensure that the fuse  $I^2t$  sets the equipment performance, the other current loop components, such as the printed wiring (PW), must have higher  $I^2t$  values than the fuse. Certainly the fuse  $I^2t$  needs to be lower than  $100 A^2s$  but other components, for example IC packaging, may impose a hazard-free limit of  $10 A^2s$ . (This conflicts with TIA/EIA-IS-968 Type A surge pass requirement of  $8 A^2s$ .)

A *yes* leads to box C and a *no* to box E.

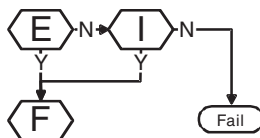

#### Boxes E and I

The criterion for box E is for a minimum telecommunications line cord of No. 26 AWG to be supplied or specified.

A *yes* leads to box F and a *no* to box I.

The criterion for box I is to pass Test 1.

If all the four pass criteria of Test 1 are met, this is a *yes* and the flow goes to box F.

A *no* result fails the equipment.

## APPLICATIONS INFORMATION

### Power Cross Pass Routes (continued)

Flow

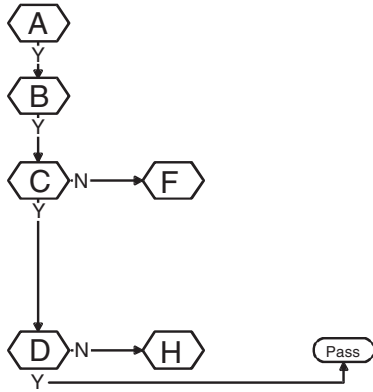

Comment

#### Boxes C and D

The criterion for box C is overcurrent protection that reduces currents above 1.3 A. This requirement is met by a 1 A fuse (a 1 A current fusing rating, not an IEC 1 A current carrying rating).

Modems which pass FCC Part 68 Type B surges and non-operationally pass Type A surges can use a fuse of 1 A or less, so the *yes* path to box D can be followed. High performance modems which operationally pass both Type A and B surges would need a fuse of greater than 1 A and so follow the *no* path to box F.

The criterion for box D is a fire enclosure.

Few modems can afford fire enclosures. However, for an internal modem in a known computer case, the case may be evaluated as a fire enclosure. A successful case evaluation will give a *yes* and an equipment pass.

More likely, the modem will not have a fire enclosure. The *no* flow goes to box H.

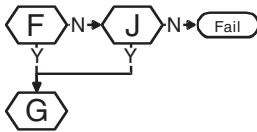

#### Boxes F and J

The criterion for box F is a pass to clause 6.3.3 requirements.

A *yes* goes to box G and a *no* goes to box J.

The criterion for box J is to pass Test 5.

If all the three pass criteria of Test 5 are met, this is a *yes* and the flow goes to box G.

A *no* result fails the equipment.

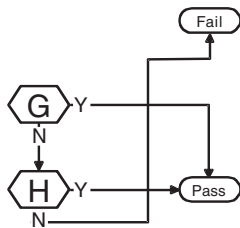

#### Boxes G and H

The criterion for box G is a fire enclosure and spacings (See box D comments).

A *yes* result passes the equipment and a *no* result leads to box H.

The criterion for box H is to pass Tests 2, 3 and 4. Test 2 is not required if there is overcurrent protection that reduces currents above 1.3 A (See box C).

High performance modems, using fuses and without fire enclosures, must pass tests 2, 3, possibly 3A if the fuse opens, and 4. For standard modems, using fuses of 1 A or less and without fire enclosures, tests 3, 3A and 4 must be passed.

If the two pass criteria of each of the tests performed are met, this is a *yes* and the equipment passes.

A *no* result fails the equipment.

## APPLICATIONS INFORMATION

### TISP4xxxL3BJ and UL 60950 Power Cross

The TISP4xxxL3BJ conducts current for periods greater than the power cross test times, Figure 2, so the TISP4xxxL3BJ is not a major factor in UL 60950 compliance. The main design task for UL 60950 power cross is about enclosure design and the selection of the other components that are subject to power cross. A UL specified fuse together with a TISP4xxxL3BJ gives a simple approach to meeting the power cross requirements.

### Fuse Values

There are two areas of fuse criteria; surge capability (TIA/EIA-IS-968 (FCC Part 68) impulse) and power cross capability (UL60950 clause 6.4 and annex NAC).

To survive an impulse, a fuse must have a melting  $I^2t$  rating greater than the impulse  $I^2t$ . The fuse  $I^2t$  rating should be specified for the impulse waveshape current as the normal d.c. rating may not result in adiabatic conditions. Alternatively, the fuse may be specified for a rated current under the impulse waveshape conditions.

An exponentially decaying impulse with a current amplitude  $I_{PP}$  and 50 % amplitude decay time of  $t_D$  has an  $I^2t$  value of  $0.72 I_{PP}^2 t_D$ . Test waveforms have tolerances and the formula can be approximated to  $I_{PP}^2 t_D$ , giving about a 40 % allowance to cover tolerances, e.g. +5 % on  $I_{PP}$  and +30 % on  $t_D$ . Using the approximate formula, the  $I^2t$  values for typical waveforms are shown in the table below.

Specification	Amplitude $I_{PP}$ A	Current Wave Shape $t_R / t_D$ ( $\mu$ s)	Melting $I^2t$ $A^2s$
TIA/EIA-IS-968 Type A (FCC Part 68)	200	10/160	6.4
	100	10/560	5.6
TIA/EIA-IS-968 Type B (FCC Part 68)	37.5	5/320	0.45
UL 60950 / ITU-T K.21	37.5	5/310	0.45
Telcordia (formally Bellcore) GR-1089-CORE	500	2/10	2.5
	100	10/1000	10
UL 60950, Annex NAC testing requires that the total $I^2t$ does not exceed 100 $A^2s$ for test 1 K.21 has a.c. induction withstand tests of 1 $A^2s$ (basic) and 10 $A^2s$ (enhanced)			

Fuse power cross current capability can be determined from its time-current curve. The fuse must be rated to break the current at the applied power cross a.c. voltage level.

### Fuses for TIA/EIA-IS-968

To survive both the Type A surges, a fuse  $I^2t$  value of greater than 6.4  $A^2s$  is needed. Fuses such as the Bel SMP 1.25 will meet this criteria and they are rated for 60 A, 600 V a.c. interruption.

Fuses must not operate on the Type B surge. To survive a 37.5 A Type B surge, the fuse needs to have an  $I^2t$  of greater than 0.45  $A^2s$ . A non-operational pass for TIA/EIA-IS-968 Type A impulses is allowed; this could be a design approach with the TISP4xxxL3, which is likely to fail short with Type A impulses. A fuse with an  $I^2t$  greater than 0.45  $A^2s$  and less than 5.6  $A^2s$  would be needed to ensure that the resultant Type A impulse fault mode disconnects the modem from the line (avoiding a permanent off-hook condition). The Bel SMP 500 fuse starts to operate at 60 % of the specified Type A impulse current levels and is rated for 60 A, 600 V a.c. interruption.

### Fuses for ITU-T Recommendation K.21

Like TIA/EIA-IS-968, K.21 requires an operation pass on a 37.5 A, 5/310 transverse current impulse, giving a minimum fuse  $I^2t$  of 0.45  $A^2s$ . This value may be increased when the coordination test requirements are included. Depending on the conformance level, basic or enhanced, an a.c. power induction operational pass requires a minimum fuse  $I^2t$  of either a 1  $A^2s$  or a 10  $A^2s$  level.

## APPLICATIONS INFORMATION

### Fuses for UL 60950

Fuses for the UL 1950 power cross need to break the specified currents at 600 V a.c. - ordinary fuses will not do! Fuse specification terms like *short circuit capabilities to UL 1459 and UL 1950/60950, 40 A, 7 A and 2.2 A at 600 V a.c.* ensure that the 600 V breaking is met.

The requirement of Figure 3, box B, limits the fuse  $I^2t$  to less than 100 A<sup>2</sup>s.

Box C, with its 1.3 A limit gives a flow division. Modems passing the TIA/EIA-IS-968 Type A surge in a non-operational mode could use a fuse of 1 A rating or less and satisfy the 1.3 A limit and move to box D. Modems operationally passing the Type A surge will tend to use a 1.25 A fuse such as the Bel SMP 1.25, and move to box F. Fuses with ratings of 2 A and above may not operate before the wiring simulator fails (typically 3 A d.c.).

## MECHANICAL DATA

### Recommended Printed Wiring Footprint

#### SMB Land Pattern

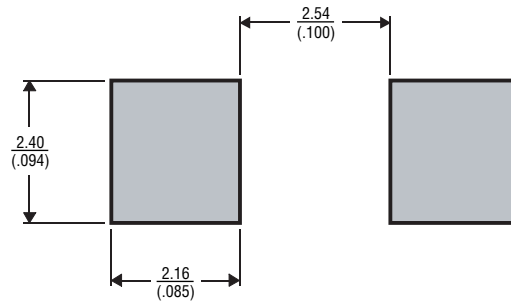

DIMENSIONS ARE:  $\frac{\text{MM}}{\text{(INCHES)}}$

MDXXBIB

### Device Symbolization Code

Devices will be coded as below. As the device parameters are symmetrical, terminal 1 is not identified.

Device	Symbolization Code
TISP4070L3BJ	4070L3
TISP4350L3BJ	4350L3

### Carrier Information

Devices are shipped in one of the carriers below. Unless a specific method of shipment is specified by the customer, devices will be shipped in the most practical carrier. For production quantities, the carrier will be embossed tape reel pack. Evaluation quantities may be shipped in bulk pack or embossed tape.

Carrier	For Standard Termination Finish Order As	For Lead Free Termination Finish Order As
Embossed Tape Reel Pack	TISP4xxxL3BJR	TISP4xxxL3BJR-S
Bulk Pack	TISP4xxxL3BJ	TISP4xxxL3BJ-S

## MECHANICAL DATA

### SMBJ (DO-214AA) Plastic Surface Mount Diode Package

This surface mount package consists of a circuit mounted on a lead frame and encapsulated within a plastic compound. The compound will withstand soldering temperature with no deformation, and circuit performance characteristics will remain stable when operated in high humidity conditions. Leads require no additional cleaning or processing when used in soldered assembly.

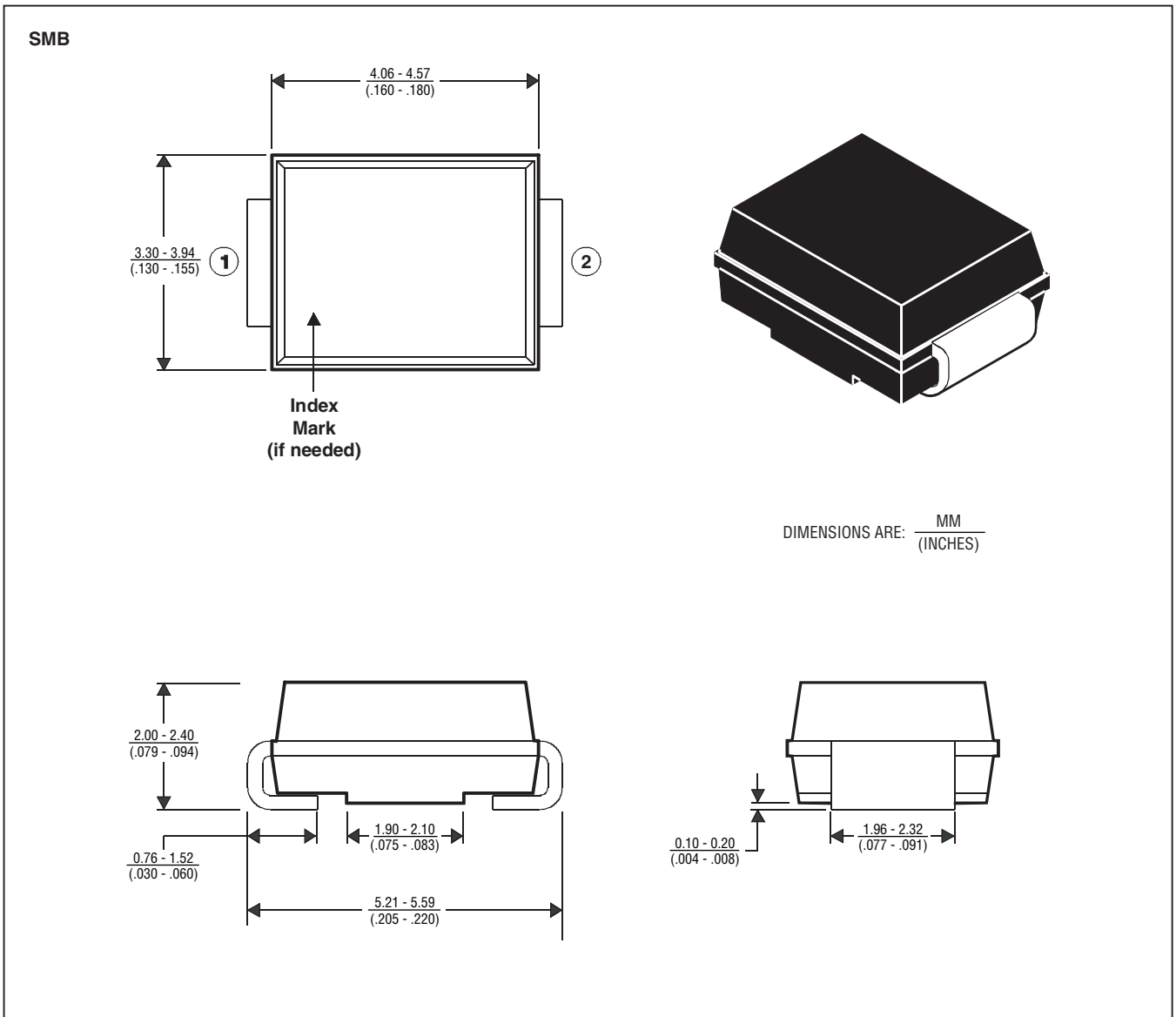

MDXXBHAB

## MECHANICAL DATA

### Tape Dimensions

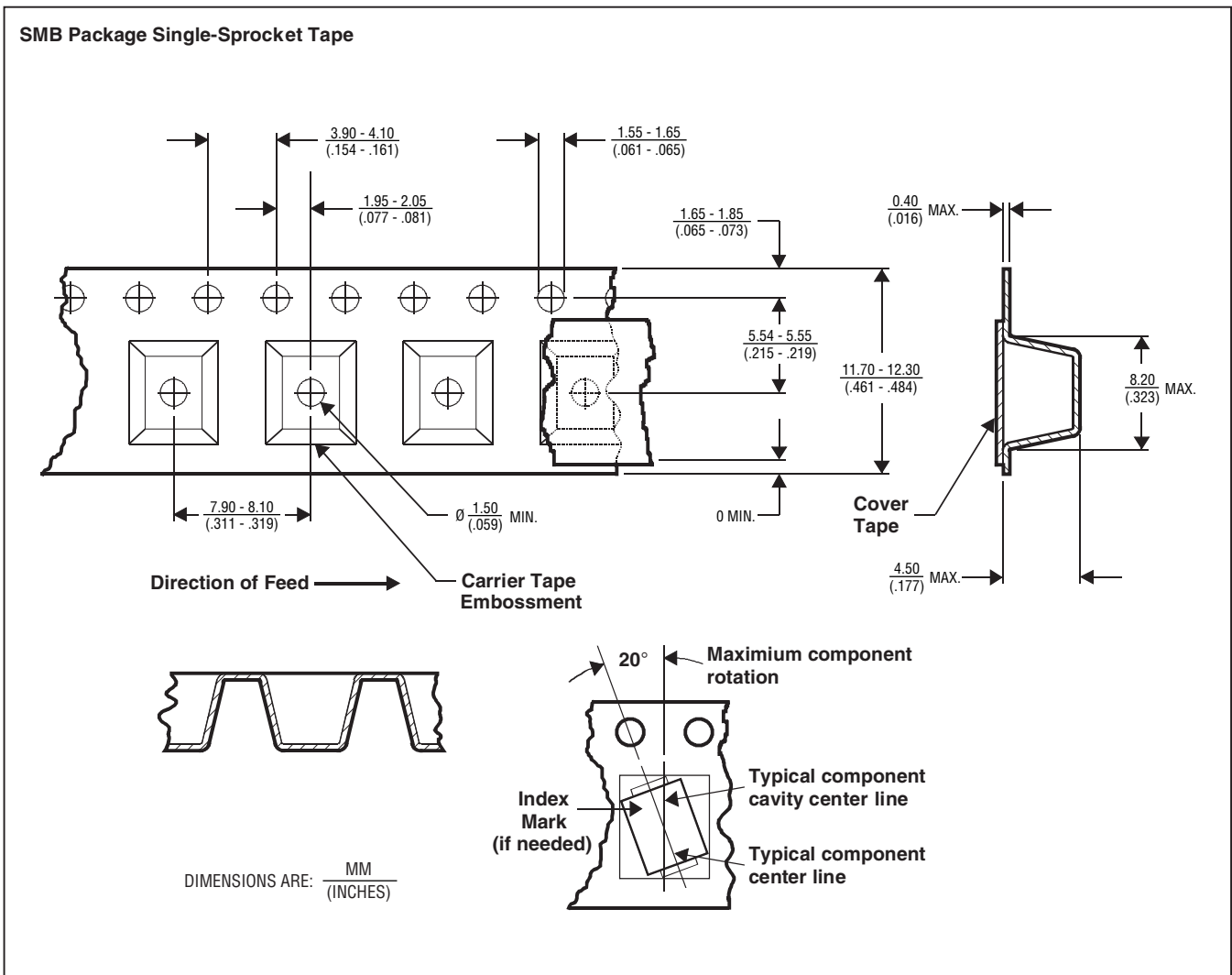

NOTES: A. The clearance between the component and the cavity must be within 0.05 mm (.002 in.) MIN. to 0.65 mm (.026 in.) MAX. so that the component cannot rotate more than 20° within the determined cavity. MDXXBJA

B. Taped devices are supplied on a reel of the following dimensions:-

Reel diameter: 330mm ± 3.0 mm (12.99 ± .118 in.)  
 Reel hub diameter: 75 mm (2.95 in.) MIN.  
 Reel axial hole: 13.0mm ± 0.5 mm (.512 ± .020 in.)

C. 3000 devices are on a reel.