

PART NAME ECNDNDBOXES

PART No. CU-123 TD CU-347 & CU-123-G TD CU-347-G CU-4123 TD CU-4347 & CU-4123-B TD CU-4347-B

REV. DATE 2-2-04

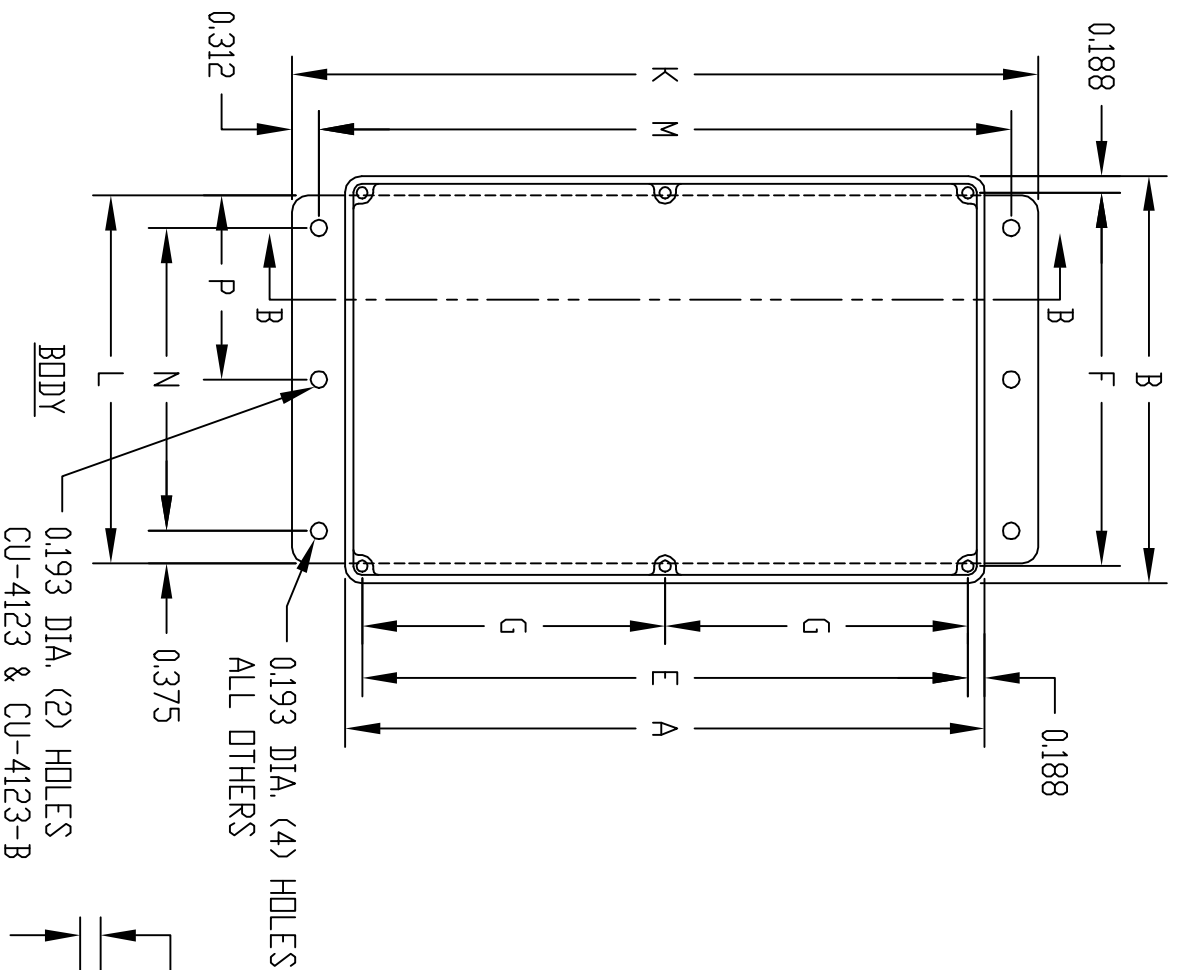
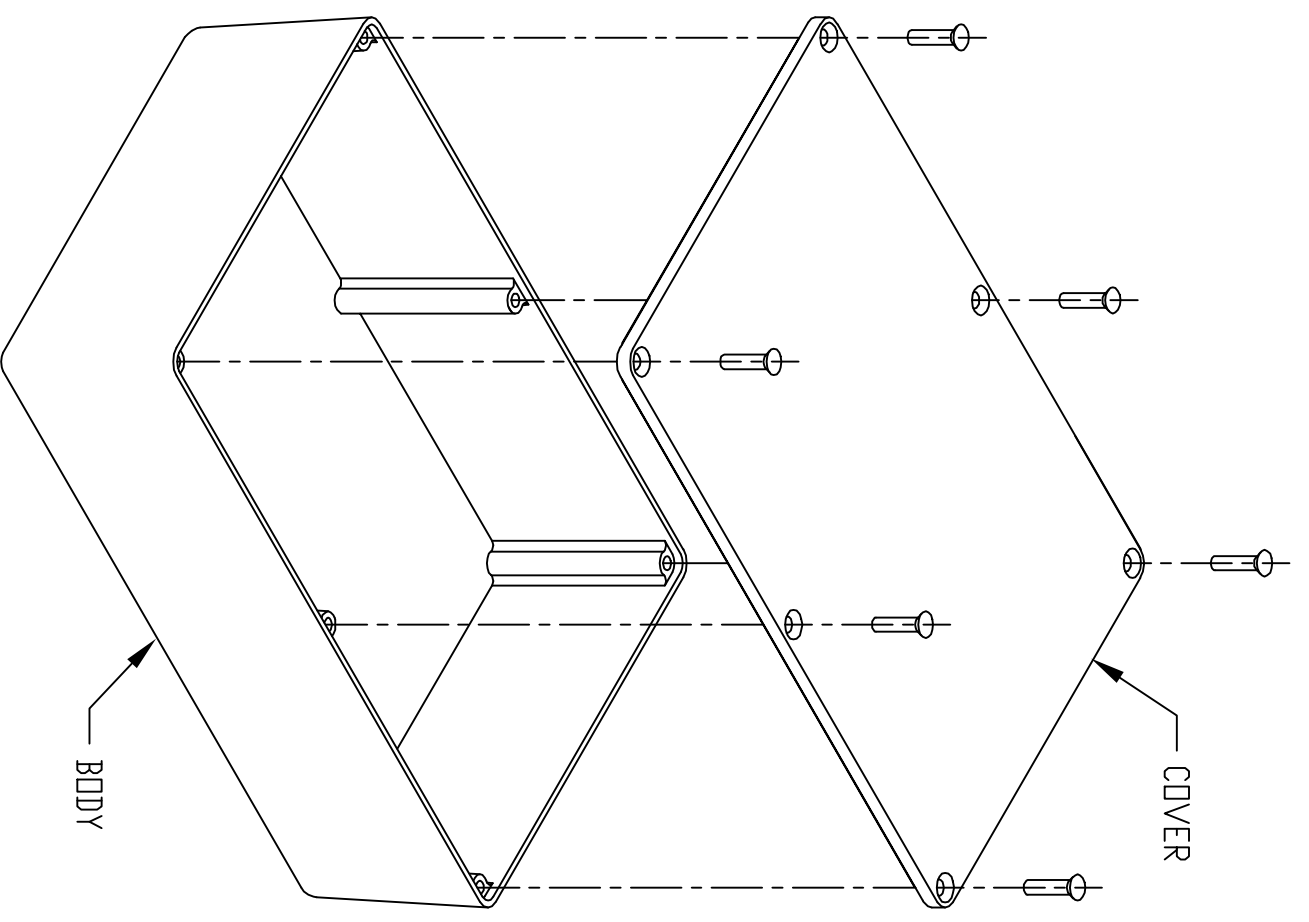
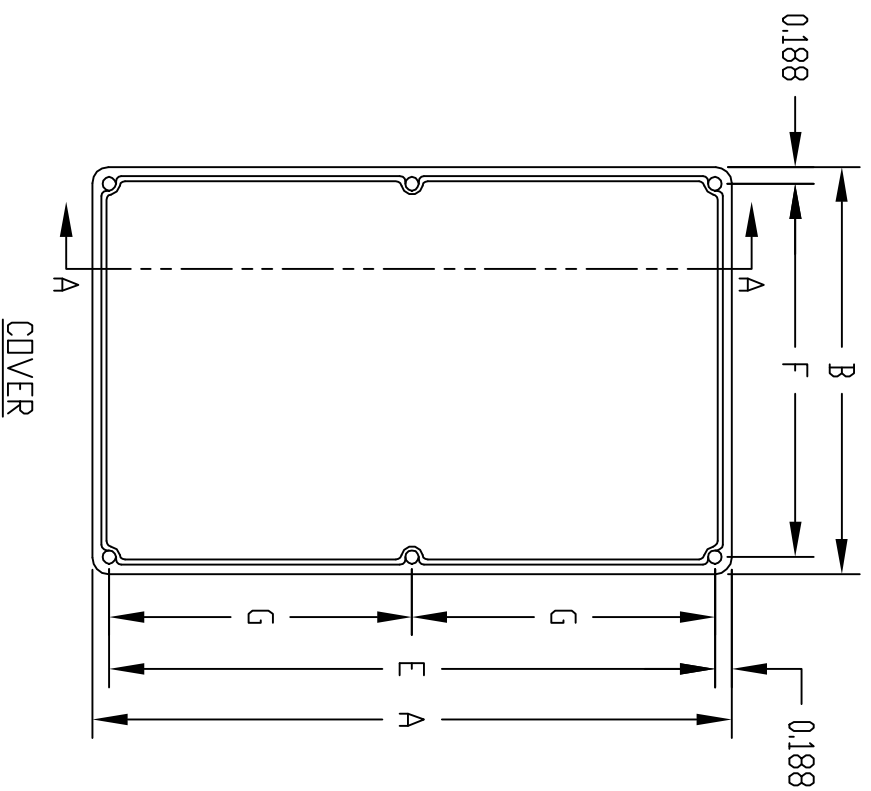

MATERIAL:
ALUMINUM ALLOY #ADC-10

FINISH:
NATURAL (ND SUFFIX)
GRAY (SUFFIX -G)
SMOOTH BLACK (SUFFIX -B)

ALL INTERNAL FILLETS 0.062 RADIUS
ALL INTERNAL ROUNDS 0.125 RADIUS
ALL EXTERNAL ROUNDS 0.125 RADIUS
ALL BOXES ASSEMBLED WITH #6-32 FLAT HD. SCREWS

PART NO. CU-4123 THRU CU-4347 AND CU-4123-B THRU CU-4347-B ARE SUPPLIED WITH A WELDED ON MOUNTING BRACKET ONLY.

* ASSEMBLED HEIGHT

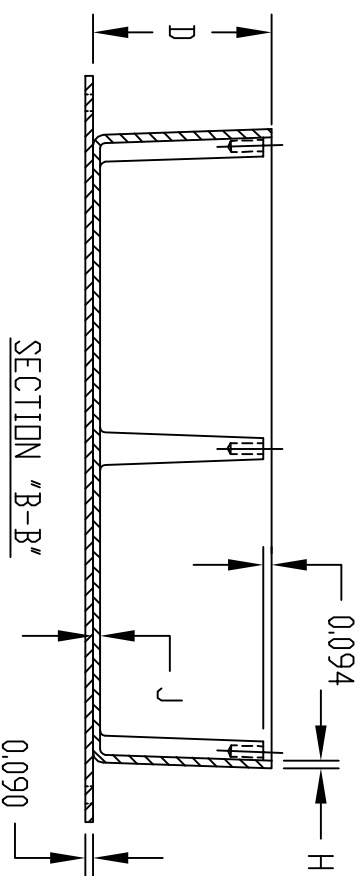
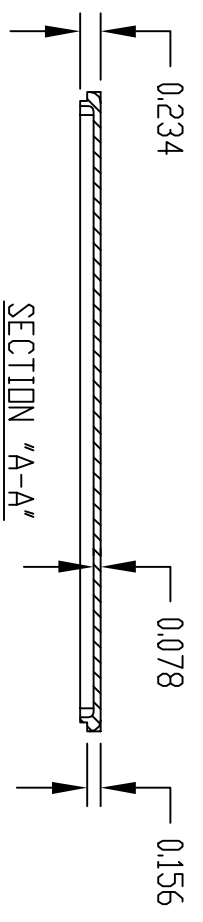

PART NO.	PART NO.	A	B	* C	D	E	F	G	H	J	K	L	M	N	P
CU-123	CU-123-G	3.625	1.500	1.218	1.062	3.250	1.125	---	0.062	0.062	---	---	---	---	---
CU-124	CU-124-G	4.375	2.375	1.218	1.062	4.000	2.000	---	0.062	0.078	---	---	---	---	---
CU-234	CU-234-G	4.688	3.688	2.218	2.062	4.312	3.312	---	0.094	0.078	---	---	---	---	---
CU-247	CU-247-G	7.390	4.703	2.218	2.062	7.000	4.312	3.500	0.094	0.078	---	---	---	---	---
CU-347	CU-347-G	7.390	4.703	3.218	3.062	7.000	4.312	3.500	0.094	0.078	---	---	---	---	---
CU-4123	CU-4123-B	3.625	1.500	1.218	1.062	3.250	1.125	---	0.062	0.062	4.874	1.250	4.250	0.500	0.625
CU-4124	CU-4124-B	4.375	2.375	1.218	1.062	4.000	2.000	---	0.062	0.078	5.624	2.000	5.000	1.250	---
CU-4234	CU-4234-B	4.688	3.688	2.218	2.062	4.312	3.312	---	0.094	0.078	5.874	3.312	5.250	2.562	---
CU-4247	CU-4247-B	7.390	4.703	2.218	2.062	7.000	4.312	3.500	0.094	0.078	8.624	4.250	8.000	3.500	---
CU-4347	CU-4347-B	7.390	4.703	3.218	3.062	7.000	4.312	3.500	0.094	0.078	8.500	4.250	7.876	3.500	---