

PART NAME	POTTING BOX (STYLE B)	PART No.	PB-1558-TF & PB-1559-TF / PB-1574-TF TO PB-1583-TF
-----------	-----------------------	----------	--

MATERIAL: ABS THERMOPLASTIC (CHI MEI POLYLAC PA-765)
 FLAMMABILITY RATING OF 94V-0 AT 0.070" THICKNESS
 AND CONTINUOUS USE TEMPERATURE OF 70° C.)

COLOR: BLACK

FINISH: OUTSIDE SURFACES ARE TEXTURED FINISH.

COVER REDUCES INSIDE HEIGHT BY 0.075,
 EXCEPT ON PB-1577-TF COVER REDUCES
 INSIDE HEIGHT BY 0.060 & PB-1583-TF COVER
 REDUCES INSIDE HEIGHT BY 0.110.

ALL COVERS HAVE SMOOTH SURFACES.

LENGTH AND WIDTH DIMENSIONS ARE
 TAKEN FROM CLOSED END OF THE BOX.
 DIMENSIONS INCREASE SLIGHTLY AT
 OPEN END DUE TO TAPER.

SHIPPED IN PACKAGES OF TEN (10).

ALL DIMENSIONS HAVE ±0.010 TOLERANCE

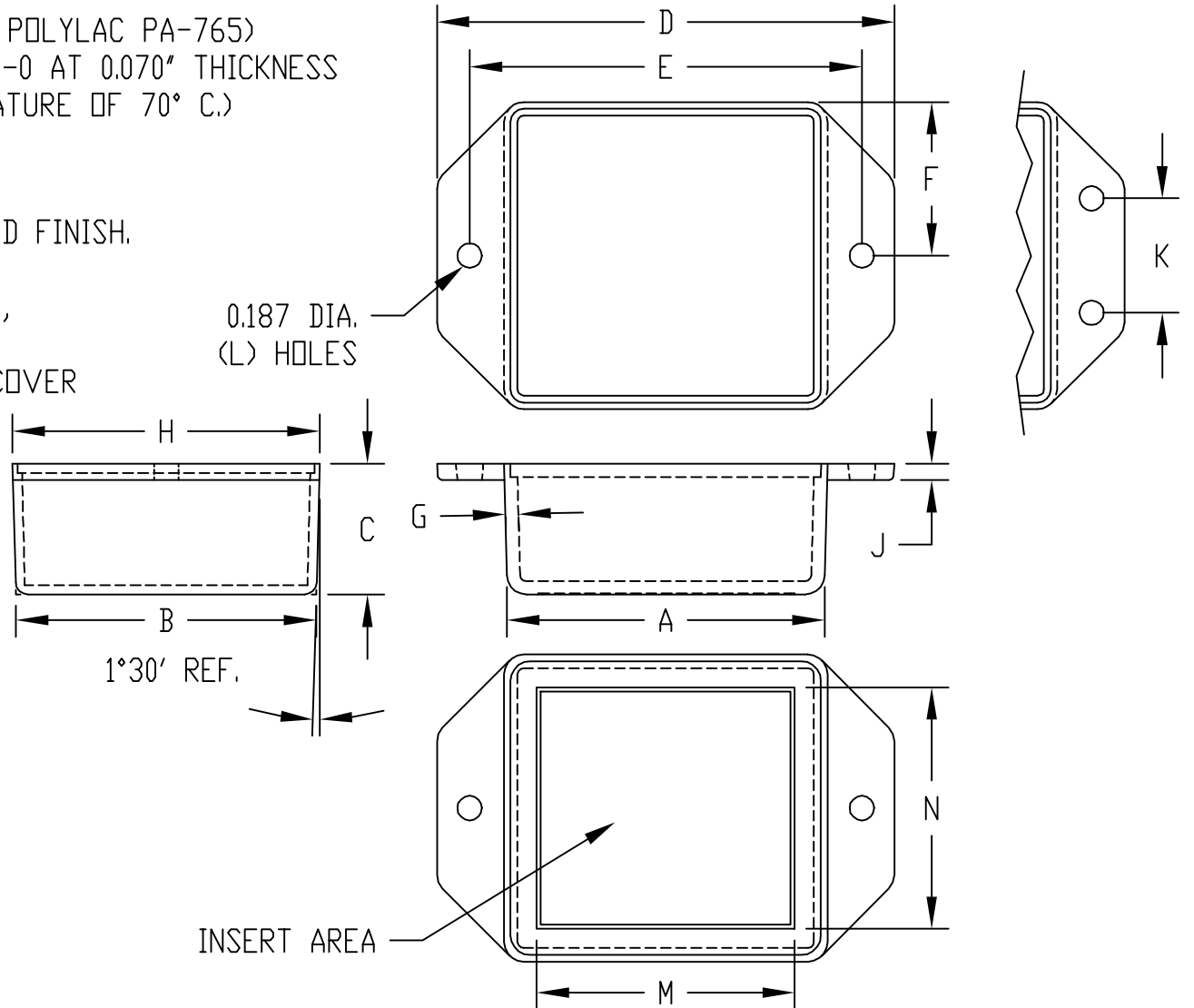

PART No.	A	B	C	D	E	F	G	H	J	K	L	M	N	OPTIONAL COVER
PB-1558-TF	2.000	1.500	1.000	2.875	2.500	0.776	0.070	1.552	0.125	----	2	----	----	PBC-1558-CN
PB-1559-TF	3.000	2.000	1.500	3.875	3.500	1.039	0.070	2.078	0.125	----	2	----	----	PBC-1575-C
PB-1574-TF	2.000	2.000	1.500	2.875	2.500	1.039	0.070	2.078	0.125	----	2	----	----	PBC-1574-C
PB-1575-TF	3.030	2.030	0.900	3.875	3.500	1.039	0.070	2.078	0.125	----	2	----	----	PBC-1575-C
PB-1576-TF	3.000	3.000	1.500	3.875	3.500	1.539	0.070	3.078	0.125	----	2	----	----	PBC-1576-C
PB-1577-TF	1.030	1.030	0.780	1.750	1.375	0.536	0.060	1.072	0.093	----	2	----	----	PBC-1577-C
PB-1578-TF	4.000	2.125	2.000	4.875	4.500	1.115	0.070	2.230	0.125	----	2	3.790	1.906	PBC-1578-C
PB-1579-TF	1.500	1.250	0.800	2.375	2.000	0.646	0.070	1.292	0.125	----	2	----	----	PBC-1579-C
PB-1580-TF	4.000	1.750	1.000	4.875	4.500	0.901	0.070	1.802	0.125	----	2	----	----	PBC-1580-C
PB-1581-TF	2.079	1.280	0.445	2.875	2.438	0.650	0.070	1.300	0.070	----	2	----	----	PBC-1581-C
PB-1582-TF	4.063	2.188	0.900	4.875	4.500	1.115	0.070	2.230	0.125	----	2	----	----	PBC-1578-C
PB-1583-TF	4.375	3.125	2.000	5.500	5.000	----	0.100	3.223	0.125	1.750	4	3.974	2.723	PBC-1583-C

PART NAME	POTTING BOX (STYLE C)	PART No.	PB-1549-BF/PB-1553-BF & PB-1554-BF/PB-1558-BF PB-1559-BF, PB-1574-BF, PB-1576-BF & PB-1577-BF
-----------	-----------------------	----------	--

MATERIAL: ABS THERMOPLASTIC (CHI MEI POLYLAC PA-765)
 FLAMMABILITY RATING OF 94V-0 AT 0.070" THICKNESS
 AND CONTINUOUS USE TEMPERATURE OF 70° C.)

COLOR: BLACK
 FINISH: SMOOTH

COVER REDUCES INSIDE HEIGHT BY 0.100
 EXCEPT ON PB-1574-BF, PB-1576-BF
 & PB-1549-BF COVER REDUCES INSIDE
 HEIGHT BY 0.094. ON PB-1577-BF COVER
 REDUCES INSIDE HEIGHT BY 0.078.

ALL COVERS HAVE SMOOTH SURFACES.

SHIPPED IN PACKAGES OF TEN (10).

ALL DIMENSIONS HAVE ±0.010 TOLERANCE

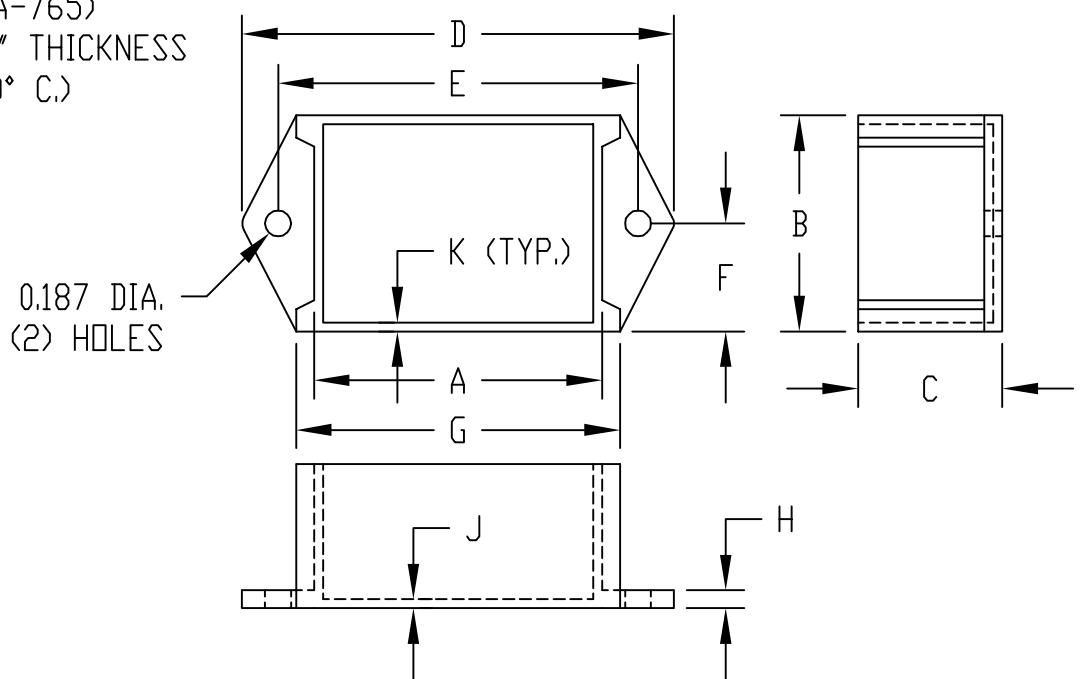

PART No.	A	B	C	D	E	F	G	H	J	K	OPTIONAL COVER
PB-1549-BF	3.050	3.050	0.875	4.000	3.500	1.538	3.324	0.125	0.085	0.082	PBC-1576-CN
PB-1553-BF	3.000	2.000	0.500	4.000	3.500	1.000	3.304	0.125	0.060	0.074	PBC-1559-C
PB-1554-BF	3.000	2.000	1.000	4.000	3.500	1.000	3.304	0.125	0.060	0.074	PBC-1559-C
PB-1558-BF	2.000	1.500	1.000	3.000	2.500	0.750	2.250	0.125	0.063	0.063	PBC-1558-C
PB-1559-BF	3.000	2.000	1.500	4.000	3.500	1.000	3.250	0.125	0.063	0.063	PBC-1559-C
PB-1574-BF	2.000	2.000	1.500	3.000	2.500	1.000	2.300	0.125	0.063	0.050	PBC-1574-CN
PB-1576-BF	3.000	3.000	1.500	4.000	3.500	1.500	3.300	0.125	0.094	0.050	PBC-1576-CN
PB-1577-BF	1.000	1.000	0.750	1.875	1.375	0.500	1.250	0.090	0.063	0.045	PBC-1577-CN