

1.5mm Sealed Header System

SHS



SHS is a complete line of sealed rugged I/O connectors. This product family is designed to perform on electronic control modules that function in extreme environmental conditions commonly found on commercial and off-road vehicles and equipment.

Product Specification

Operating Temperature

-40°C to +125°C

Contact Resistance

< 10 mΩ

Insulation Resistance

>1000 MΩ

Sealing

IP65, IP66, IP67, IP69K

Temperature Life

1008 Hrs @ 125°C

Current Cycling

500 Hrs @ 10 Amp

500 cycles 45 min ON – 15 min OFF

Vibration

10 to 2000 to 10 Hz with 15 g's peak level

Shock

50 g's – 20 pulses

Salt Spray

96 Hrs

Temperature Humidity Cycling

320 Hrs

40 – 8 Hrs cycles -40°C to +85°C @ 85%RH to +125°C

Fluid Resistance

Resistant to most fluids used in industrial applications

Headers

- 18, 30, 48 and 60 I/O
- Post plated pins
- Epoxy sealed pins
- Silicone interface seals and panel gaskets
- Ferrite filtering option for EMI/RFI protection
 - ◆ Attenuation 3 - 7 dB

Harness Connectors

- 18 and 30 position
- Push to seat terminal
- Terminal secondary lock
- Integral grommet wire seal with protective backplate

Contact Cinch for RoHS compliant SHS products

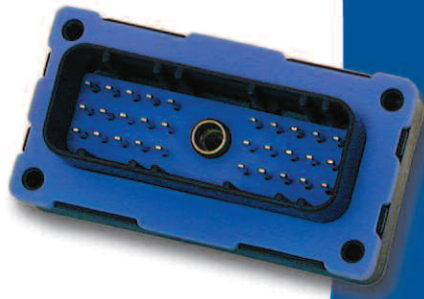
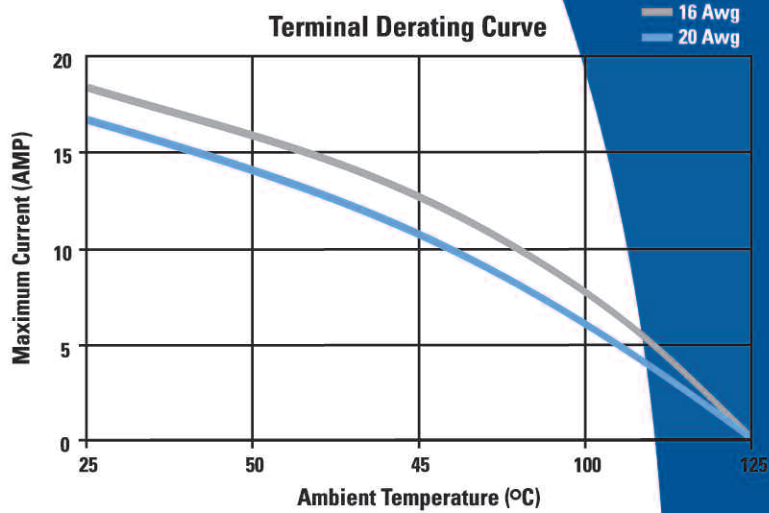

SHS Headers / Harness Connector Matrix

Header		Header Features			Harness Connector	
I/O	P/N	Key	Color	Filter	P/N Mate 1	P/N Mate 2
18	581 01 18 001	A	BLK	Ferrite	581 01 18 023	N/A
18	581 01 18 002	B	NAT	Ferrite	581 01 18 024	N/A
18	581 01 18 011	A	BLK	No Ferrite	581 01 18 023	N/A
18	581 01 18 012	B	NAT	No Ferrite	581 01 18 024	N/A
30	581 01 30 001	A	GREY	Ferrite	581 01 30 027	N/A
30	581 01 30 002	B	BLK	Ferrite	581 01 30 028	N/A
30	581 01 30 011	A	GREY	No Ferrite	581 01 30 027	N/A
30	581 01 30 013	A	BLK	No Ferrite	581 01 30 027	N/A
48	581 01 48 001	A	BLK	Ferrite	581 01 180 23	581 01 30 029
48	581 01 48 002	B	NAT	Ferrite	581 01 18 024	581 01 30 030
48	581 01 48 003	C	GREY	Ferrite	581 01 18 023	581 01 30 027
48	581 01 48 011	A	BLK	No Ferrite	581 01 18 023	581 01 30 029
48	581 01 48 012	B	NAT	No Ferrite	581 01 18 024	581 01 30 030
48	581 01 48 013	C	GREY	No Ferrite	581 01 18 023	581 01 30 027
60	581 01 60 001	A	BLK	Ferrite	581 01 30 029	581 01 30 028
60	581 01 60 002	B	NAT	Ferrite	581 01 30 031	581 01 30 030
60	581 01 60 011	A	BLK	No Ferrite	581 01 30 029	581 01 30 028
60	581 01 60 012	B	NAT	No Ferrite	581 01 30 031	581 01 30 030

SHS Harness Connectors

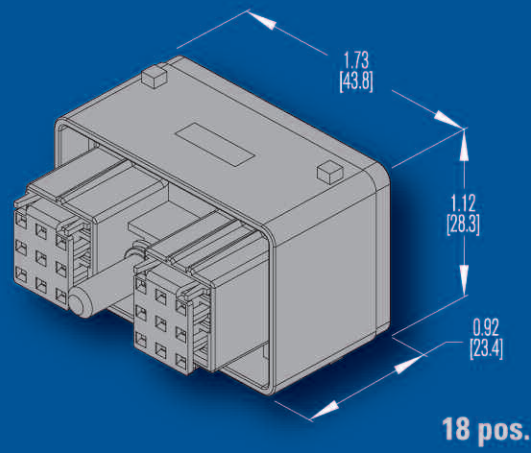

Position	Part Number	Color
18	581 01 18 023	Black
18	581 01 18 034	White
30	581 01 30 027	Grey
30	581 01 30 028	Black
30	581 01 30 029	Black
30	581 01 30 030	White
30	581 01 30 031	White

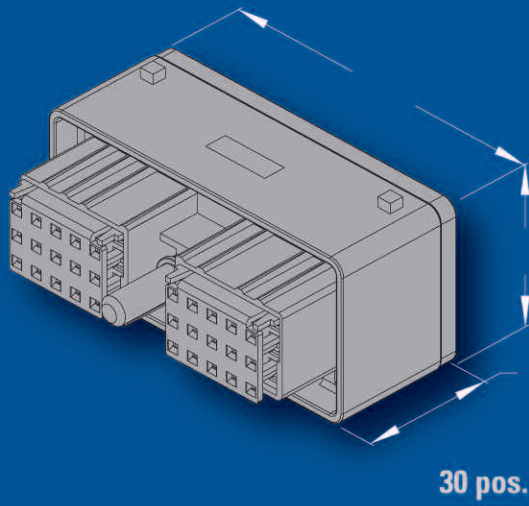

SHS Terminal

Wire Size	Part Number
20GXL, 18TXL	425 00 00 872
18GXL, 16TXL, 16 GXL	425 00 00 873

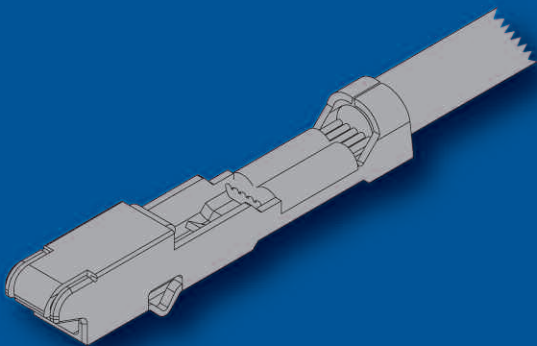

Cavity Seal Plug

Part Number
581 00 00 011

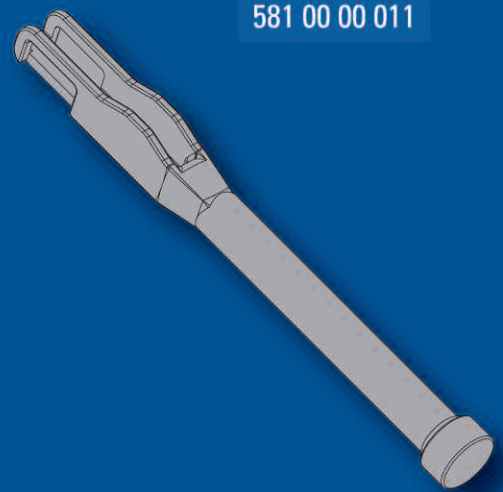

Contact Cinch for connector assembly instructions and application tooling

SHS Headers

I/O	P/N With Ferrite	P/N Without Ferrite	Color
18 I/O	581 01 18 001	581 01 18 011	Black
18 I/O	581 01 18 002	581 01 18 012	Natural
30 I/O	581 01 30 001	581 01 30 011	Grey
30 I/O	581 01 30 002	581 01 30 013	Black
48 I/O	581 01 48 001	581 01 48 011	Black
48 I/O	581 01 48 002	581 01 48 012	Natural
48 I/O	581 01 48 003	581 01 48 013	Grey
60 I/O	581 01 60 001	581 01 60 011	Black
60 I/O	581 01 60 002	581 01 60 012	Natural

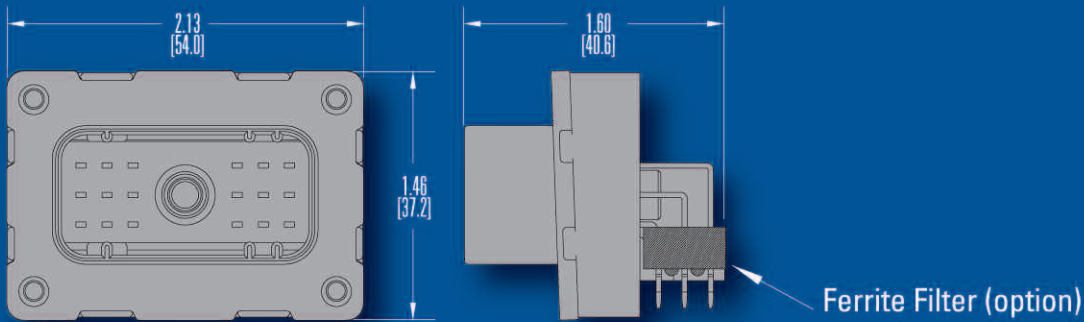

18 I/O

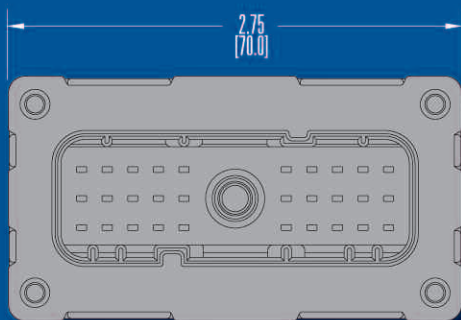

30 I/O

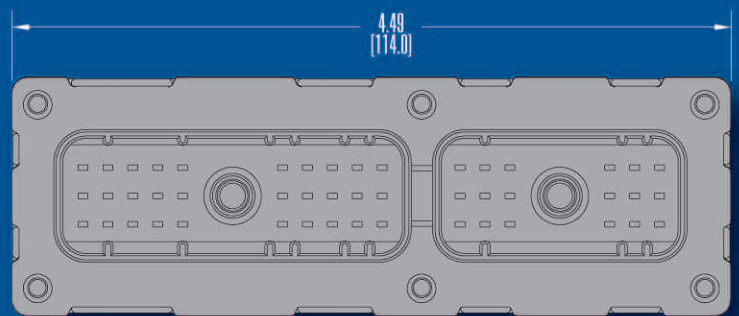

48 I/O

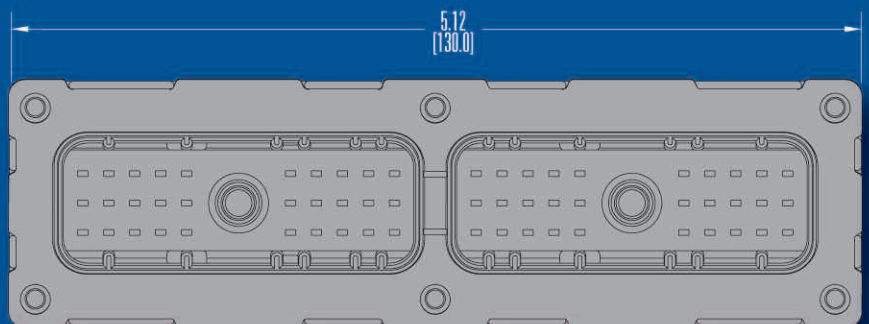

60 I/O

Proven Excellence

For over 70 years, Cinch has been a reliable supplier of a variety of quality connector products to various industries. We are a multi-national manufacturer with manufacturing facilities in the U.S., U.K. and Mexico.

Cinch has applied its extensive expertise in interconnection technology to engineer and manufacture connectors of various complexities using state-of-the-art technology and tooling. Mechanical design is accomplished using Pro/E® 3D solid modeling and AutoCAD® supported by nonlinear and linear Finite Element Analysis, and Mold Flow software.

Our engineers utilize in-house capabilities in high frequency interconnect simulation, SPICE model generation and high frequency testing to develop the optimum product.

All products are validated in Cinch's First Article, mechanical, electrical, and environmental test facilities ensuring the finished products meet our customers' most stringent specifications.

Simply, your connectors are manufactured in state-of-the-art facilities that are committed to customer satisfaction and continuous improvement.



Cinch Connectors
1700 Finley Road
Lombard, IL 60148 USA
Phone: 630.705.6000
1.800.323.9612
Fax: 630.705.6060
E-mail: info@cinch.com



Cinch Connectors Ltd.
Shireoaks Road
Worksop S80 3HA
Nottinghamshire, U.K.
Phone: +44 (0) 1909 474 131
Fax: +44 (0) 1909 478 321
E-mail: info@cinchuk.com