

10326.4

PK 300/4/5,08 DG

PK 300/4/5,08 DG

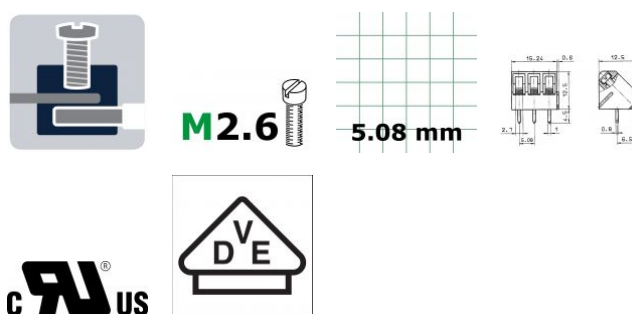

PCB terminal, Screw connection, No. of poles: 4, Width: 20.92 mm, Colour: Dark grey

Business data

Packaging unit	50
Quantity unit	PC
Packaging type	Carton
Type of banding	Without
Weight per piece (not including packaging)	5.37
Weight per piece (including packaging)	5.77
Unit of weight	G
Customs number	85369010
Country of origin	QU

10326.4

PK 300/4/5,08 DG

PK 300/4/5,08 DG

Technical Data

Dimensions

Length	12.5 mm
Length of the pin	4.5 mm
Width	20.92 mm
Width left	2.54 mm
Width right	3.14 mm
Height	12.5 mm
Drill hole diameter	1.3 mm
Diameter of connecting pin	1 mm
Pitch	5.08 mm

Ratings

Rated voltage	250 V
Rated current	24 A
Rated cross-section	1.5 mm ²
Rated impulse voltage	2 kV
Overvoltage category	III
Contamination degree	3

10326.4

PK 300/4/5,08 DG

PK 300/4/5,08 DG

Technical Data

Connection data

Connection principle	Screw connection
Connection type of PCB	Solder connection
Type of attachment to circuit board	Connecting contact
Angle of PCB/wire connection	45°/135° (slanted upwards)
No. of poles	4
Number of levels	1
Wire cross-section single-core (rigid) / stranded, min.	0.14 mm ²
Wire cross-section single core (rigid)/stranded, max.	2.5 mm ²
Wire cross-section stranded, min.	0.14 mm ²
Wire cross-section stranded, max.	1.5 mm ²
Wire cross-section stranded with wire-end ferrules, min.	0.25 mm ²
Wire cross-section stranded with wire-end ferrules, max.	1.5 mm ²
Wire cross-section AWG, min.	22
Wire cross-section AWG, max.	12
Stripping length	7 mm
Screw threading	M 2,6
Torque	0.4 Nm

10326.4

PK 300/4/5,08 DG

PK 300/4/5,08 DG

Technical Data

Materials

Insulation housing	Polyamide 6.6
Flammability class UL 94	V-0
Working temperature, min.	-30 °C
Working temperature, max.	105 °C
Clamping element	Brass
Screws	Steel
Soldering lug	Copper alloy

Further technical data

Storage temperature, min.	-40 °C
Storage temperature, max.	105 °C
Insulation resistance	1*10 ¹³ Ohm x cm
Creepage-current resistance	CTI 600
Glow wire flammability index GWFI	GWFI 850
GWFI after-glow time	30 Sek.
Glow wire ignition temperature GWIT	GWIT 775 °C
GWIT exposure time	5 Sek.
Connection cycles, in compliance with standard	5
Recommended wave soldering temperature	265 °C

10326.4

PK 300/4/5,08 DG

PK 300/4/5,08 DG

Technical Data

Further technical data

Recommended wave soldering duration, min.	3 Sek.
---	--------

Recommended wave soldering duration, max.	4 Sek.
---	--------

10326.4

PK 300/4/5,08 DG

PK 300/4/5,08 DG

Approvals

cUL Recognized

cUL Recognized	C22.2 No 158
cUL Recognized	✓
cUL Usegroup D: rated voltage	300 V
cUL Usegroup D: rated current	15 A
cUL wire cross-section stranded AWG, min.	22
cUL wire cross-section stranded AWG, max.	12
cUL torque	0.5 Nm
cUL wire material	Cu

UL Recognized

UL Recognized	UL 1059
UL Recognized granted	✓
UL Usegroup D: rated voltage	300 V
UL Usegroup D: rated current	15 A
UL wire cross-section stranded AWG, min.	22
UL wire cross-section stranded AWG, max.	12
UL torque	4.43 Lb In
UL wire material	Cu
UL factory wiring	✓

10326.4

PK 300/4/5,08 DG

PK 300/4/5,08 DG

Approvals

UL Recognized

UL field wiring	✓
-----------------	---

VDE approval

VDE approval	DIN EN 60998
--------------	--------------

VDE approval granted	✓
----------------------	---

VDE rated voltage	250 V
-------------------	-------

VDE rated current	24 A
-------------------	------

VDE rated current wire cross-section rigid, max.	24 A
--	------

VDE rated current wire cross-section stranded, max.	24 A
---	------

VDE rated impulse voltage	2 kV
---------------------------	------

VDE wire cross-section rigid, min.	0.5 mm ²
------------------------------------	---------------------

VDE wire cross-section rigid, max.	2.5 mm ²
------------------------------------	---------------------

VDE wire cross-section stranded, min.	0.5 mm ²
---------------------------------------	---------------------

VDE wire cross-section stranded, max.	1.5 mm ²
---------------------------------------	---------------------

VDE screw threading	M 2,6
---------------------	-------

VDE torque	0.4 Nm
------------	--------

VDE overvoltage category	III
--------------------------	-----

VDE contamination degree	3
--------------------------	---

10326.4

PK 300/4/5,08 DG

PK 300/4/5,08 DG

Media



M2.6

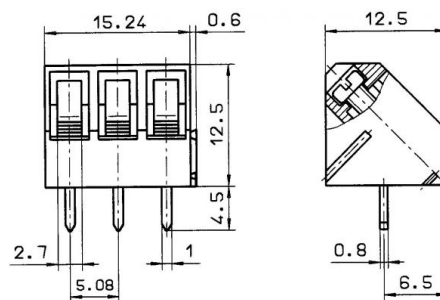
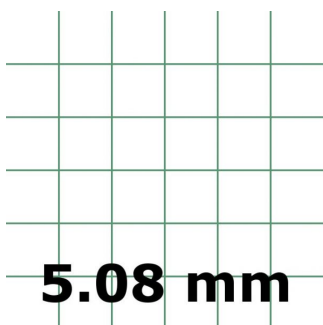

CRV[®] US

