

12057.0

PZK 3191/2/2,50-KD LG

PZK 3191/2/2,50-KD LG

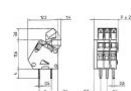
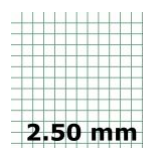

PCB terminal, Tension-spring connection, No. of poles: 2, Width: 7 mm, Colour: Pebble grey

Business data

Packaging unit	50
Quantity unit	PC
Packaging type	Carton
Type of banding	Without
Weight per piece (not including packaging)	0.8
Weight per piece (including packaging)	0.9
Unit of weight	G
Customs number	85369010
Country of origin	QU

12057.0

PZK 3191/2/2,50-KD LG

PZK 3191/2/2,50-KD LG

Technical Data

Dimensions

Length	12.2 mm
Length of the pin	4 mm
Width	7 mm
Width left	2.7 mm
Width right	1.8 mm
Height	11.6 mm
Drill hole diameter	1.1 mm
Diameter of connecting pin	0.8 mm
Pitch	2.5 mm

Ratings

Rated voltage	130 V
Rated current	9 A
Rated cross-section	0.5 mm ²
Rated impulse voltage	1.25 kV
Overvoltage category	III
Contamination degree	3

12057.0

PZK 3191/2/2,50-KD LG

PZK 3191/2/2,50-KD LG

Technical Data

Connection data

Connection principle	Tension-spring connection
Connection type of PCB	Solder connection
Type of attachment to circuit board	Connecting contact
Angle of PCB/wire connection	45°/135° (slanted upwards)
No. of poles	2
Number of levels	1
Wire cross-section single-core (rigid) / stranded, min.	0.08 mm ²
Wire cross-section single core (rigid)/stranded, max.	1 mm ²
Wire cross-section stranded, min.	0.14 mm ²
Wire cross-section stranded, max.	0.5 mm ²
Wire cross-section stranded with wire-end ferrules, min.	0.14 mm ²
Wire cross-section stranded with wire-end ferrules, max.	0.14 mm ²
Wire cross-section AWG, min.	28
Wire cross-section AWG, max.	20
Stripping length	5 mm

12057.0

PZK 3191/2/2,50-KD LG

PZK 3191/2/2,50-KD LG

Technical Data

Materials

Insulation housing	Polyamide 6.6
Flammability class UL 94	V-0
Working temperature, min.	-30 °C
Working temperature, max.	105 °C
Tension spring	Stainless steel
Soldering lug	Copper alloy

Further technical data

Storage temperature, min.	-40 °C
Storage temperature, max.	105 °C
Insulation resistance	1*10 ¹³ Ohm x cm
Creepage-current resistance	CTI 600
Glow wire flammability index GWFI	GWFI 850
GWFI after-glow time	30 Sek.
Glow wire ignition temperature GWIT	GWIT 775 °C
GWIT exposure time	5 Sek.
Connection cycles, in compliance with standard	10
Recommended wave soldering temperature	265 °C
Recommended wave soldering duration, min.	3 Sek.

12057.0

PZK 3191/2/2,50-KD LG

PZK 3191/2/2,50-KD LG

Technical Data

Further technical data

Recommended wave soldering duration, max.	4 Sek.
---	--------

12057.0

PZK 3191/2/2,50-KD LG

PZK 3191/2/2,50-KD LG

Approvals

cUL Recognized

cUL Recognized	CSA 22.2 No.158
cUL Recognized	✓
cUL Usegroup B: rated voltage	150 V
cUL Usegroup B: rated current	4 A
cUL wire cross-section single-core (rigid) AWG, min.	28
cUL wire cross-section single-core (rigid) AWG, max.	20
cUL wire cross-section stranded AWG, min.	28
cUL wire cross-section stranded AWG, max.	20
cUL wire material	Cu

12057.0

PZK 3191/2/2,50-KD LG

PZK 3191/2/2,50-KD LG

Approvals

UL Recognized

UL Recognized	UL 1059
UL Recognized granted	✓
UL Usegroup B: rated voltage	150 V
UL Usegroup B: rated current	4 A
UL wire cross-section single-core (rigid) AWG, min.	28
UL wire cross-section single-core (rigid) AWG, max.	20
UL wire cross-section stranded AWG, min.	28
UL wire cross-section stranded AWG, max.	20
UL wire material	Cu
UL factory wiring	✓
UL field wiring	✓

12057.0

PZK 3191/2/2,50-KD LG

PZK 3191/2/2,50-KD LG

Approvals

VDE approval

VDE approval	DIN EN 60998
VDE approval granted	✓
VDE rated voltage	130 V
VDE rated current	9 A
VDE rated current wire cross-section rigid, max.	9 A
VDE rated impulse voltage	1.25 kV
VDE wire cross-section rigid, min.	0.2 mm ²
VDE wire cross-section rigid, max.	0.5 mm ²
VDE overvoltage category	III
VDE contamination degree	3

12057.0

PZK 3191/2/2,50-KD LG

PZK 3191/2/2,50-KD LG

Media

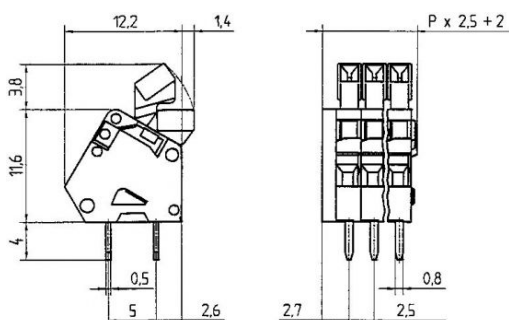
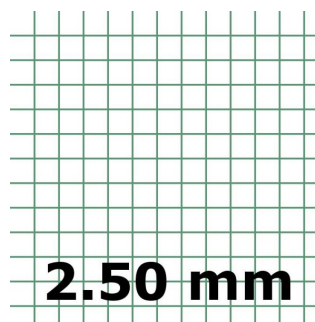

CRU[®] US

