

1492.2

RK 16/IS BG

RK 16/IS BG

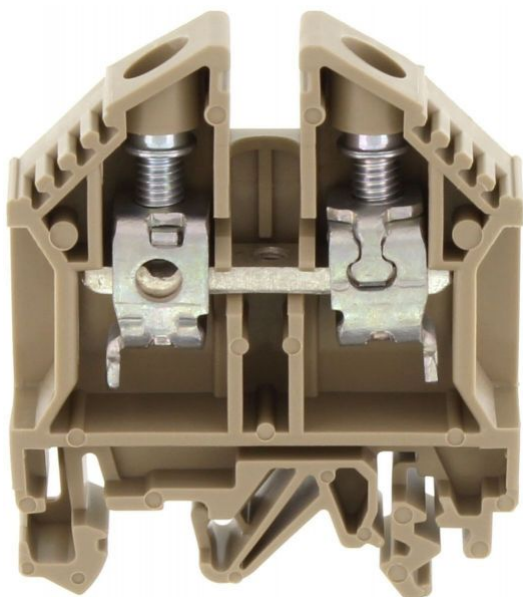

Feed-through terminal, Screw connection, Mounting type: Mounting rail TS 35/7.5 and TS 32, Rated cross-section: 16 mm<sup>2</sup>, Width: 12 mm, Colour: Beige

## Business data

Product description	Feed-through terminal
Packaging unit	50
Quantity unit	PC
Weight per piece (not including packaging)	28
Weight per piece (including packaging)	29.68
Unit of weight	G
Customs number	85369010
Country of origin	DE

1492.2

RK 16/IS BG

RK 16/IS BG

## Technical Data

---

### Dimensions

---

Length	50 mm
Width	12 mm
Height TS 35/7.5	58.5 mm
Height TS 32	63 mm

### Ratings

---

Rated voltage	800 V
Rated current	76 A
Rated cross-section	16 mm <sup>2</sup>
Rated impulse voltage	8 kV
Overvoltage category	III
Contamination degree	3

1492.2

RK 16/IS BG

RK 16/IS BG

## Technical Data

---

### Connection data

Connection principle	Screw connection
Connection position	Lateral
Connections	2
Number of terminals per level	2
Number of levels	1
Wire cross-section single-core (rigid) / stranded, min.	2.5 mm <sup>2</sup>
Wire cross-section single core (rigid)/stranded, max.	25 mm <sup>2</sup>
Wire cross-section stranded, min.	70 mm <sup>2</sup>
Wire cross-section stranded, max.	240 mm <sup>2</sup>
Wire cross-section stranded with wire-end ferrules, min.	2.5 mm <sup>2</sup>
Wire cross-section stranded with wire-end ferrules, max.	16 mm <sup>2</sup>
Wire cross-section AWG, min.	10
Wire cross-section AWG, max.	6
Stripping length	15 mm
Screw head	Inner hex (Allen)
Screw threading	M 5
Tightening torque, min.	2 Nm
Tightening torque, max.	4 Nm

1492.2

RK 16/IS BG

RK 16/IS BG

## Technical Data

---

### Materials

---

Insulation housing	Polyamide 6.6
--------------------	---------------

Flammability class UL 94	V-2
--------------------------	-----

Working temperature, min.	-40 °C
---------------------------	--------

Working temperature, max.	105 °C
---------------------------	--------

### Further technical data

---

Mounting type	Mounting rail TS 35/7.5 and TS 32
---------------	-----------------------------------

Gauge plug acc. to EN 60 947-1	B7
--------------------------------	----

Number of cross-connection channels	1
-------------------------------------	---

End plate required	✓
--------------------	---

1492.2

RK 16/IS BG

RK 16/IS BG

## Approvals

---

### Standards and regulations

---

EAC approval	TR ZU 004/2011
--------------	----------------

EAC approval granted	✓
----------------------	---

### CSA approval

---

CSA approval	C22.2 No 158
--------------	--------------

CSA approval granted	✓
----------------------	---

CSA Usegroup C: rated voltage	600 V
-------------------------------	-------

CSA Usegroup C: rated current	70 A
-------------------------------	------

CSA wire cross-section AWG, min.	10
----------------------------------	----

CSA wire cross-section AWG, max.	6
----------------------------------	---

CSA stripping length	15 mm
----------------------	-------

CSA torque, max.	4 Nm
------------------	------

CSA torque, min.	2 Nm
------------------	------

1492.2

RK 16/IS BG

RK 16/IS BG

## Approvals

---

### German Lloyd approval

---

GL approval	IEC 60947-7-1
GL approval granted	✓
GL rated voltage	750 V
GL rated current	82 A
GL rated cross-section	16 mm <sup>2</sup>
GL environmental category	C

### KEMA KEUR approval

---

KEMA KEUR approval	EN 60947-7-1
KEMA KEUR approval granted	✓
KEMA rated voltage	800 V
KEMA rated current	76 A
KEMA rated impulse voltage	8 kV
KEMA wire cross-section single core (rigid), min.	2.5 mm <sup>2</sup>
KEMA wire cross-section single-core (rigid), max.	25 mm <sup>2</sup>
KEMA wire cross-section stranded, min.	2.5 mm <sup>2</sup>
KEMA wire cross-section stranded, max.	16 mm <sup>2</sup>

1492.2

RK 16/IS BG

RK 16/IS BG

## Approvals

---

### UL Recognized

UL Recognized	UL 1059
UL Recognized granted	✓
UL Usegroup C: rated voltage	600 V
UL Usegroup C: rated current	65 A
UL wire cross-section single-core (rigid) AWG, min.	10
UL wire cross-section single-core (rigid) AWG, max.	6
UL wire cross-section stranded AWG, min.	10
UL wire cross-section stranded AWG, max.	6
UL torque	10.5 Lb In
UL wire material	Cu
UL factory wiring	✓
UL field wiring	✓

1492.2

RK 16/IS BG

RK 16/IS BG

Media

---

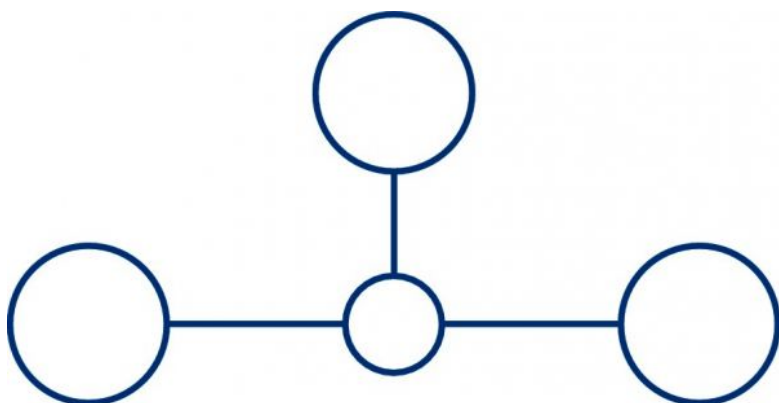

**M5**

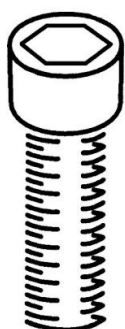

**EAC**

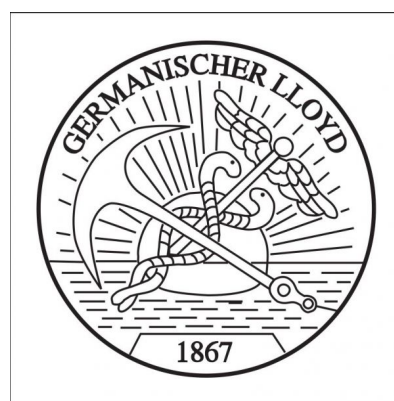



1492.2

RK 16/IS BG

RK 16/IS BG

Media

---



1492.2

RK 16/IS BG

RK 16/IS BG

## Accessories

---

### Cover

---



Cover, Length: 26.5 mm, Width: 12 mm, Colour: White

### In general

Order number	Article designation	GTIN (EAN)	Packaging unit
2969.0	AD 1/12	4044211056988	20 PC

---



Cover, Length: 30 mm, Width: 10.7 mm, Colour: Yellow

### In general

Order number	Article designation	GTIN (EAN)	Packaging unit
2819.0	AD 1/12/B	4044211055455	20 PC

---

1492.2

RK 16/IS BG

RK 16/IS BG

## Accessories

---

### End plate

---

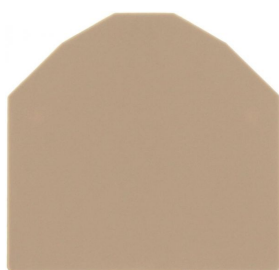

End plate, Width: 1.5 mm, Colour: Beige

### In general

Order number	Article designation	GTIN (EAN)	Packaging unit
2104.2	AP 16	4044211049164	20 PC

### End bracket

---



End stop, Mounting type: Mounting rail TS 35/7.5,  
Width: 9.5 mm, Colour: Beige

### In general

Order number	Article designation	GTIN (EAN)	Packaging unit
2828.0	ES 35/K/ST	4044211055547	50 PC

1492.2

RK 16/IS BG

RK 16/IS BG

## Accessories

---

### Cross connector

---



Cross-connector, No. of poles: 10, Mounting type: Can be screwed on, Width: 115.3 mm, Rated cross-section: 16 mm<sup>2</sup>, Colour: natural

### In general

Order number	Article designation	GTIN (EAN)	Packaging unit
2115.0	Q 10	4044211049294	10 PC

---

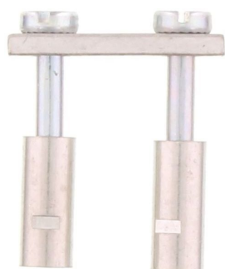

Cross-connector, No. of poles: 2, Mounting type: Can be screwed on, Width: 20.1 mm, Rated cross-section: 16 mm<sup>2</sup>, Colour: natural

### In general

Order number	Article designation	GTIN (EAN)	Packaging unit
2112.0	Q 2	4044211049263	20 PC

---

1492.2

RK 16/IS BG

RK 16/IS BG

## Accessories

---

### Cross connector

---

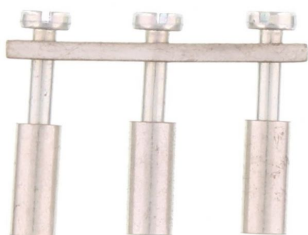

Cross-connector, No. of poles: 3, Mounting type: Can be screwed on, Width: 32 mm, Rated cross-section: 16 mm<sup>2</sup>, Colour: natural

### In general

Order number	Article designation	GTIN (EAN)	Packaging unit
2113.0	Q 3	4044211049270	20 PC

---

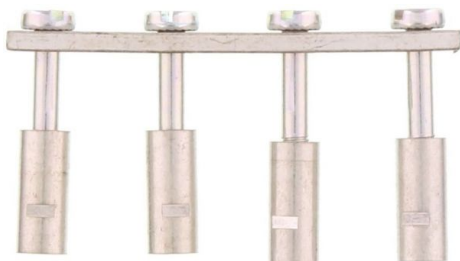

Cross-connector, No. of poles: 4, Mounting type: Can be screwed on, Width: 43.9 mm, Rated cross-section: 16 mm<sup>2</sup>, Colour: natural

### In general

Order number	Article designation	GTIN (EAN)	Packaging unit
2114.0	Q 4	4044211049287	10 PC

---

1492.2

RK 16/IS BG

RK 16/IS BG

## Accessories

---

### Quick-marking

---

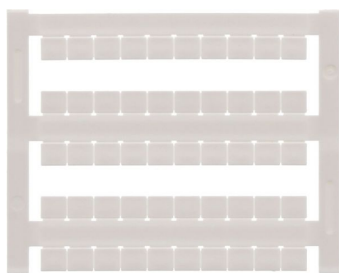

Terminal marker / Pocket Maxicard, Length: 5 mm,  
Width: 6 mm, Colour: White

---

### In general

Order number	Article designation	GTIN (EAN)	Packaging unit
4702.7	PMC SB 6/50 WH	4044211089986	500 PC

---

### Partition plate

---

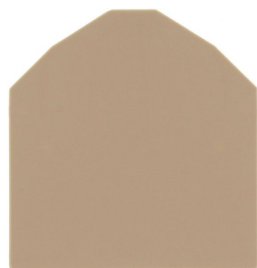

Partition plate, Width: 1.5 mm, Colour: Beige

---

### In general

Order number	Article designation	GTIN (EAN)	Packaging unit
2105.2	TW 16	4044211049195	20 PC

---