

2314.2

RKD 4/LED1(RD)/60V DC BG

RKD 4/LED1(RD)/60V DC BG

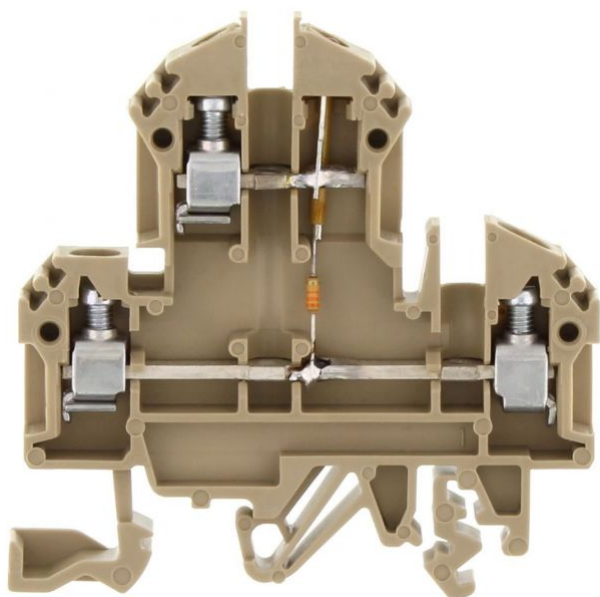

Double-level terminal with electronic components, Screw connection, Mounting type: Mounting rail TS 35/7.5 and TS 32, Rated cross-section: 4 mm², Width: 6 mm, Colour: Beige

Business data

| | |
|--|---|
| Product description | Double-level terminals with electronic components |
| Packaging unit | 100 |
| Quantity unit | PC |
| Weight per piece (not including packaging) | 12.6 |
| Weight per piece (including packaging) | 13.37 |
| Unit of weight | G |
| Customs number | 85369010 |
| Country of origin | DE |

2314.2

RKD 4/LED1(RD)/60V DC BG

RKD 4/LED1(RD)/60V DC BG

Technical Data

Dimensions

| | |
|------------------|---------|
| Length | 60.2 mm |
| Width | 6 mm |
| Height TS 35/7.5 | 61 mm |
| Height TS 32 | 65.5 mm |

Ratings

| | |
|-----------------------|-------------------|
| Rated voltage | 60 DC V |
| Rated current | 10 A |
| Rated cross-section | 4 mm ² |
| Rated impulse voltage | 6 kV |
| Overvoltage category | III |
| Contamination degree | 3 |

2314.2

RKD 4/LED1(RD)/60V DC BG

RKD 4/LED1(RD)/60V DC BG

Technical Data

Connection data

| | |
|--|---------------------|
| Connection principle | Screw connection |
| Connection position | Lateral |
| Number of terminals per level | 2 |
| Number of levels | 2 |
| Wire cross-section single-core (rigid) / stranded, min. | 0.2 mm ² |
| Wire cross-section single core (rigid)/stranded, max. | 4 mm ² |
| Wire cross-section stranded, min. | 0.2 mm ² |
| Wire cross-section stranded, max. | 4 mm ² |
| Wire cross-section stranded with wire-end ferrules, min. | 0.2 mm ² |
| Wire cross-section stranded with wire-end ferrules, max. | 4 mm ² |
| Wire cross-section AWG, min. | 22 |
| Wire cross-section AWG, max. | 12 |
| Stripping length | 9 mm |
| Screw head | Slotted |
| Screw threading | M 3 |
| Tightening torque, min. | 0.5 Nm |
| Tightening torque, max. | 1 Nm |

2314.2

RKD 4/LED1(RD)/60V DC BG

RKD 4/LED1(RD)/60V DC BG

Technical Data

Materials

| | |
|---------------------------|---------------|
| Insulation housing | Polyamide 6.6 |
| Flammability class UL 94 | V-2 |
| Working temperature, min. | -40 °C |
| Working temperature, max. | 105 °C |

Further technical data

| | |
|---------------------------------------|-----------------------------------|
| Mounting type | Mounting rail TS 35/7.5 and TS 32 |
| Gauge plug acc. to EN 60 947-1 | A4 |
| Number of cross-connection channels | 2 |
| End plate required | ✓ |
| Voltage illuminated display | 60 DC V |
| Cross-current via illuminated display | 5 mA |
| Colour of lamp | Red |

2314.2

RKD 4/LED1(RD)/60V DC BG

RKD 4/LED1(RD)/60V DC BG

Approvals

Standards and regulations

| | |
|--------------|----------------|
| EAC approval | TR ZU 004/2011 |
|--------------|----------------|

| | |
|----------------------|---|
| EAC approval granted | ✓ |
|----------------------|---|

CSA approval

| | |
|--------------|--------------|
| CSA approval | C22.2 No 158 |
|--------------|--------------|

| | |
|----------------------|---|
| CSA approval granted | ✓ |
|----------------------|---|

| | |
|-------------------------------|-------|
| CSA Usegroup C: rated voltage | 300 V |
|-------------------------------|-------|

| | |
|-------------------------------|------|
| CSA Usegroup C: rated current | 25 A |
|-------------------------------|------|

| | |
|----------------------------------|----|
| CSA wire cross-section AWG, min. | 22 |
|----------------------------------|----|

| | |
|----------------------------------|----|
| CSA wire cross-section AWG, max. | 12 |
|----------------------------------|----|

| | |
|----------------------|------|
| CSA stripping length | 9 mm |
|----------------------|------|

| | |
|------------------|------|
| CSA torque, max. | 1 Nm |
|------------------|------|

| | |
|------------------|--------|
| CSA torque, min. | 0.5 Nm |
|------------------|--------|

2314.2

RKD 4/LED1(RD)/60V DC BG

RKD 4/LED1(RD)/60V DC BG

Approvals

German Lloyd approval

| | |
|---------------------------|-------------------|
| GL approval | IEC 60947-7-1 |
| GL approval granted | ✓ |
| GL rated voltage | 500 V |
| GL rated current | 34 A |
| GL rated cross-section | 4 mm ² |
| GL environmental category | C |

KEMA KEUR approval

| | |
|---|---------------------|
| KEMA KEUR approval | EN 60947-7-1 |
| KEMA KEUR approval granted | ✓ |
| KEMA rated voltage | 500 V |
| KEMA rated current | 32 A |
| KEMA rated impulse voltage | 6 kV |
| KEMA wire cross-section single core (rigid), min. | 0.2 mm ² |
| KEMA wire cross-section single-core (rigid), max. | 4 mm ² |
| KEMA wire cross-section stranded, min. | 0.2 mm ² |
| KEMA wire cross-section stranded, max. | 4 mm ² |

2314.2

RKD 4/LED1(RD)/60V DC BG

RKD 4/LED1(RD)/60V DC BG

Approvals

UL Recognized

| | |
|---|---------|
| UL Recognized | UL 1059 |
| UL Recognized granted | ✓ |
| UL Usegroup C: rated voltage | 300 V |
| UL Usegroup C: rated current | 30 A |
| UL wire cross-section single-core (rigid) AWG, min. | 22 |
| UL wire cross-section single-core (rigid) AWG, max. | 10 |
| UL wire cross-section stranded AWG, min. | 22 |
| UL wire cross-section stranded AWG, max. | 10 |
| UL torque | 7 Lb In |
| UL wire material | Cu |
| UL factory wiring | ✓ |
| UL field wiring | ✓ |

2314.2

RKD 4/LED1(RD)/60V DC BG

RKD 4/LED1(RD)/60V DC BG

Media

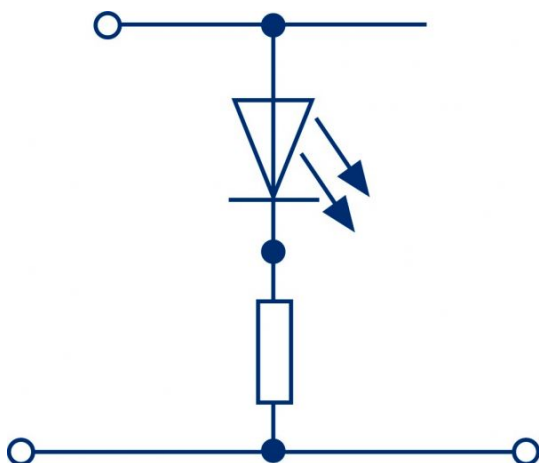

M3

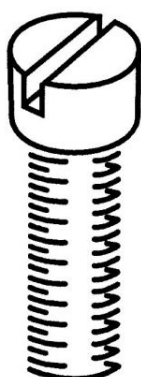

EAC

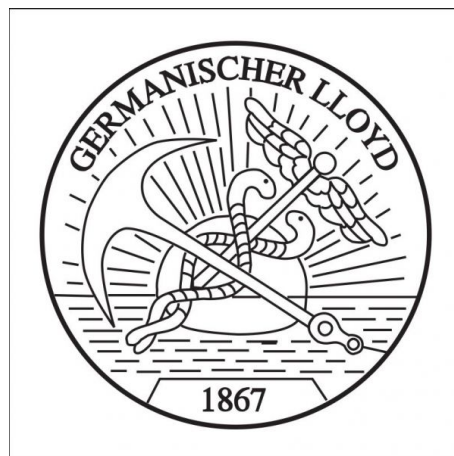

2314.2

RKD 4/LED1(RD)/60V DC BG

RKD 4/LED1(RD)/60V DC BG

Media



2314.2

RKD 4/LED1(RD)/60V DC BG

RKD 4/LED1(RD)/60V DC BG

Accessories

End plate

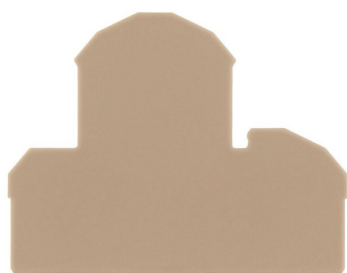

End plate, Width: 1.5 mm, Colour: Beige

In general

| Order number | Article designation | GTIN (EAN) | Packaging unit |
|--------------|---------------------|---------------|----------------|
| 2101.2 | AP 4 | 4044211151652 | 20 PC |

Insulation plate



Insulation plate, Colour: Beige

In general

| Order number | Article designation | GTIN (EAN) | Packaging unit |
|--------------|---------------------|---------------|----------------|
| 2566.2 | TRS 3 | 4044211053567 | 100 PC |

2314.2

RKD 4/LED1(RD)/60V DC BG

RKD 4/LED1(RD)/60V DC BG

Accessories

Cross connector



Cross-connector, No. of poles: 10, Mounting type: Can be screwed on, Width: 59.3 mm, Rated cross-section: 4 mm², Colour: natural

In general

| Order number | Article designation | GTIN (EAN) | Packaging unit |
|--------------|---------------------|---------------|----------------|
| 2090.0 | Q 10 | 4044211048983 | 10 PC |

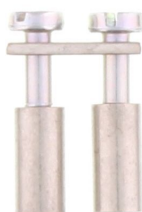

Cross-connector, No. of poles: 2, Mounting type: Can be screwed on, Width: 10.5 mm, Rated cross-section: 4 mm², Colour: natural

In general

| Order number | Article designation | GTIN (EAN) | Packaging unit |
|--------------|---------------------|---------------|----------------|
| 2087.0 | Q 2 | 4044211048952 | 50 PC |

2314.2

RKD 4/LED1(RD)/60V DC BG

RKD 4/LED1(RD)/60V DC BG

Accessories

Cross connector



Cross-connector, No. of poles: 3, Mounting type: Can be screwed on, Width: 16.6 mm, Rated cross-section: 4 mm², Colour: natural

In general

| Order number | Article designation | GTIN (EAN) | Packaging unit |
|--------------|---------------------|---------------|----------------|
| 2088.0 | Q 3 | 4044211048969 | 50 PC |



Cross-connector, No. of poles: 4, Mounting type: Can be screwed on, Width: 22.7 mm, Rated cross-section: 4 mm², Colour: natural

In general

| Order number | Article designation | GTIN (EAN) | Packaging unit |
|--------------|---------------------|---------------|----------------|
| 2089.0 | Q 4 | 4044211048976 | 20 PC |

2314.2

RKD 4/LED1(RD)/60V DC BG

RKD 4/LED1(RD)/60V DC BG

Accessories

End bracket

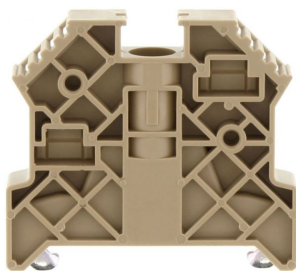

End stop, Mounting type: Mounting rail TS 35/7.5,
Width: 9.5 mm, Colour: Beige

In general

| Order number | Article designation | GTIN (EAN) | Packaging unit |
|--------------|---------------------|---------------|----------------|
| 2828.0 | ES 35/K/ST | 4044211055547 | 50 PC |

Screw driver



Screwdriver with bare blade, Colour: Black-grey

In general

| Order number | Article designation | GTIN (EAN) | Packaging unit |
|--------------|---------------------|---------------|----------------|
| 1086.0 | SDB 0,6x3,5 | 4044211014797 | 1 PC |

2314.2

RKD 4/LED1(RD)/60V DC BG

RKD 4/LED1(RD)/60V DC BG

Accessories

Quick-marking

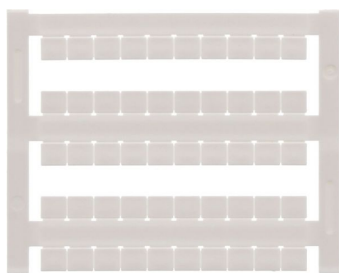

Terminal marker / Pocket Maxicard, Length: 5 mm,
Width: 6 mm, Colour: White

In general

| Order number | Article designation | GTIN (EAN) | Packaging unit |
|--------------|---------------------|---------------|----------------|
| 4702.7 | PMC SB 6/50 WH | 4044211089986 | 500 PC |

Jacks



Socket plug, M 2.5, Colour: natural

In general

| Order number | Article designation | GTIN (EAN) | Packaging unit |
|--------------|---------------------|---------------|----------------|
| 2075.0 | STB 8,5/2,3 | 4044211048839 | 50 PC |

2314.2

RKD 4/LED1(RD)/60V DC BG

RKD 4/LED1(RD)/60V DC BG

Accessories

Test plug



Test plug, Colour: Red

In general

| Order number | Article designation | GTIN (EAN) | Packaging unit |
|--------------|---------------------|---------------|----------------|
| 2007.0 | PS 2,3 | 4044211048105 | 20 PC |
