

2584.2

RKDG 4 BG

RKDG 4 BG

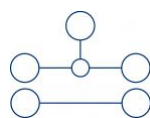
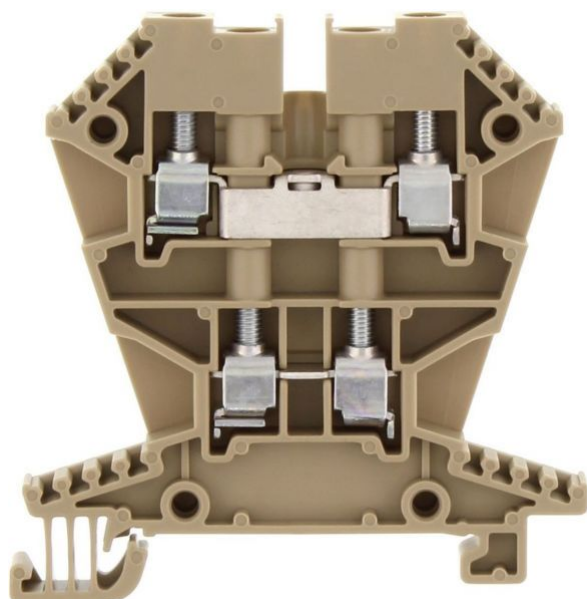

M3



Double-level terminal, Screw connection, Mounting type: Mounting rail TS 35/7.5, Rated cross-section: 4 mm², Width: 6 mm, Colour: Beige

Business data

Product description	Double-level terminal
Packaging unit	100
Quantity unit	PC
Weight per piece (not including packaging)	15.2
Weight per piece (including packaging)	16.06
Unit of weight	G
Customs number	85369010
Country of origin	DE

2584.2

RKDG 4 BG

RKDG 4 BG

Technical Data

Dimensions

Length	58.5 mm
Width	6 mm
Height TS 35/7.5	60 mm

Ratings

Rated voltage	500 V
Rated current	32 A
Rated cross-section	4 mm ²
Rated impulse voltage	6 kV
Overvoltage category	III
Contamination degree	3

2584.2

RKDG 4 BG

RKDG 4 BG

Technical Data

Connection data

Connection principle	Screw connection
Connection position	Lateral
Connections	2 x 2
Number of terminals per level	2
Number of levels	2
Wire cross-section single-core (rigid) / stranded, min.	0.2 mm ²
Wire cross-section single core (rigid)/stranded, max.	4 mm ²
Wire cross-section stranded, min.	0.2 mm ²
Wire cross-section stranded, max.	4 mm ²
Wire cross-section stranded with wire-end ferrules, min.	0.2 mm ²
Wire cross-section stranded with wire-end ferrules, max.	4 mm ²
Wire cross-section AWG, min.	22
Wire cross-section AWG, max.	12
Stripping length	9 mm
Screw head	Slotted
Screw threading	M 3
Tightening torque, min.	0.5 Nm
Tightening torque, max.	1 Nm

2584.2

RKDG 4 BG

RKDG 4 BG

Technical Data

Materials

Insulation housing	Polyamide 6.6
Flammability class UL 94	V-2
Working temperature, min.	-40 °C
Working temperature, max.	105 °C

Further technical data

Mounting type	Mounting rail TS 35/7,5
Gauge plug acc. to EN 60 947-1	A4
Number of cross-connection channels	1
End plate required	✓

2584.2

RKDG 4 BG

RKDG 4 BG

Approvals

Standards and regulations

EAC approval	TR ZU 004/2011
--------------	----------------

EAC approval granted	✓
----------------------	---

KEMA KEUR approval

KEMA KEUR approval	EN 60947-7-1
--------------------	--------------

KEMA KEUR approval granted	✓
----------------------------	---

KEMA rated voltage	500 V
--------------------	-------

KEMA rated current	32 A
--------------------	------

KEMA rated impulse voltage	6 kV
----------------------------	------

KEMA wire cross-section single core (rigid), min.	0.2 mm ²
---	---------------------

KEMA wire cross-section single-core (rigid), max.	4 mm ²
---	-------------------

KEMA wire cross-section stranded, min.	0.2 mm ²
--	---------------------

KEMA wire cross-section stranded, max.	4 mm ²
--	-------------------

2584.2

RKDG 4 BG

RKDG 4 BG

Media

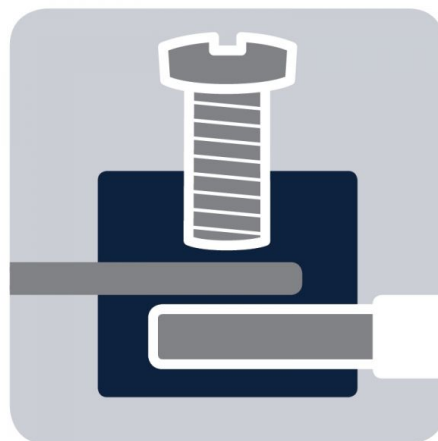
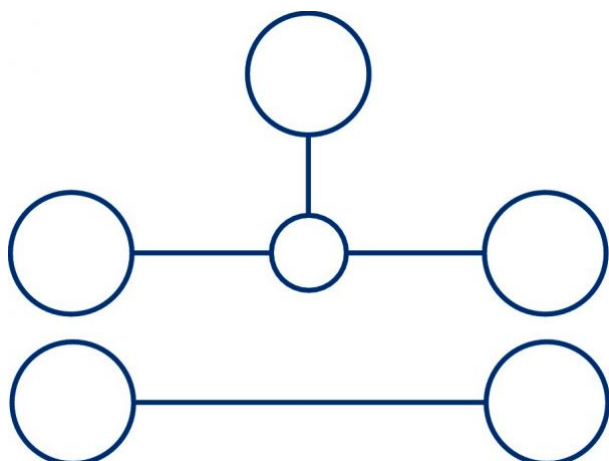

M3

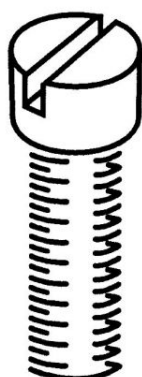

2584.2

RKDG 4 BG

RKDG 4 BG

Accessories

End plate

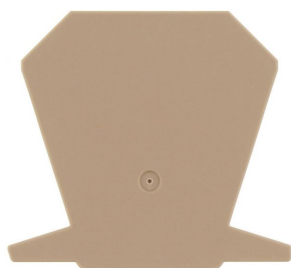

End plate, Width: 1.5 mm, Colour: Beige

In general

Order number	Article designation	GTIN (EAN)	Packaging unit
2586.2	APG 4	4044211049089	20 PC

Cross connector



Cross-connector, No. of poles: 10, Mounting type: Can be screwed on, Width: 59.3 mm, Rated cross-section: 4 mm², Colour: natural

In general

Order number	Article designation	GTIN (EAN)	Packaging unit
2090.0	Q 10	4044211048983	10 PC

2584.2

RKDG 4 BG

RKDG 4 BG

Accessories

Cross connector

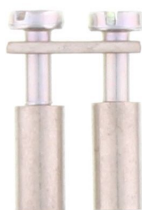

Cross-connector, No. of poles: 2, Mounting type: Can be screwed on, Width: 10.5 mm, Rated cross-section: 4 mm², Colour: natural

In general

Order number	Article designation	GTIN (EAN)	Packaging unit
2087.0	Q 2	4044211048952	50 PC



Cross-connector, No. of poles: 3, Mounting type: Can be screwed on, Width: 16.6 mm, Rated cross-section: 4 mm², Colour: natural

In general

Order number	Article designation	GTIN (EAN)	Packaging unit
2088.0	Q 3	4044211048969	50 PC

2584.2

RKDG 4 BG

RKDG 4 BG

Accessories

Cross connector



Cross-connector, No. of poles: 4, Mounting type: Can be screwed on, Width: 22.7 mm, Rated cross-section: 4 mm², Colour: natural

In general

Order number	Article designation	GTIN (EAN)	Packaging unit
2089.0	Q 4	4044211048976	20 PC

End bracket



End stop, Mounting type: Mounting rail TS 35/7.5, Width: 9.5 mm, Colour: Beige

In general

Order number	Article designation	GTIN (EAN)	Packaging unit
2828.0	ES 35/K/ST	4044211055547	50 PC

2584.2

RKDG 4 BG

RKDG 4 BG

Accessories

Screw driver



Screwdriver with bare blade, Colour: Black-grey

In general

Order number	Article designation	GTIN (EAN)	Packaging unit
1086.0	SDB 0,6x3,5	4044211014797	1 PC

Quick-marking

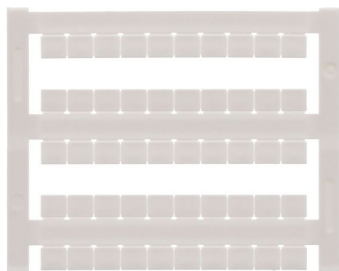

Terminal marker / Pocket Maxicard, Length: 5 mm,
Width: 6 mm, Colour: White

In general

Order number	Article designation	GTIN (EAN)	Packaging unit
4702.7	PMC SB 6/50 WH	4044211089986	500 PC