

**LOW-PROFILE SLIDE SWITCHES**

# CUS SERIES

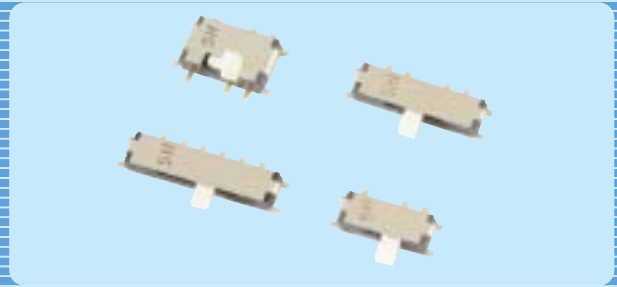

**Outline dimensions**

- **1P2T** : 2.6 mm × 6.7 mm × 1.4 mm
- **1P3T** : 2.6 mm × 9.7 mm × 1.4 mm
- **1P4T** : 2.6 mm × 11.3 mm × 1.4 mm

- **2P2T** : 4.1 mm × 6.7 mm × 1.4 mm

## FEATURES

- Low-profile of 1.4 mm
- RoHS compliant (Lead-free, Cadmium-free)

## APPLICATIONS

- Mobile stereo · LCD TV · Camcorder

## PART NUMBER DESIGNATION

**C U S - 1 2 T B**

**Series name**

**No. of poles**

- 1 : 1 pole
- 2 : 2 poles

**No. of contacts**

- 2 : 2 contacts
- 3 : 3 contacts
- 4 : 4 contacts

**Shape of terminal**

B : Gull wing

**Form of packaging**

T : Taping

## LIST OF PART NUMBERS

No. of poles	No. of contacts	Shape of terminal	Form of packaging	Part number	Pieces in package
1	2	B (Gull wing)	Taping	CUS-12TB	2,500 pcs./reel
	3			CUS-13TB	
	4			CUS-14TB	
2	2			CUS-22TB	1,400 pcs./reel

## SPECIFICATIONS

Item	Specification	
<b>Standard characteristics</b>	Operating Temp. range	- 20 ~ 70 °C
	Storage Temp. range	- 40 ~ 85 °C
	Sealing	Non-washable
<b>Electrical characteristics</b>	Non-switching	DC50 V 100 mA
	Switching	DC4 V 300 mA
	Contact resistance	70 mΩ maximum
	Insulation resistance	100 MΩ minimum (DC 100 V)
	Dielectric strength	AC100 V 60 s

Item	Specification	
<b>Mechanical characteristics</b>	Stroke	1.5 mm
	Operation force	1.5 ± 1.2 N {0.15 ± 0.12 kgf} 2 ± 1.7 N {0.2 ± 0.17 kgf}
	Load life	10,000 cycles minimum
	Soldering heat	Reflow peak 250 ~ 255 °C over 230 °C 30 s
<b>Pieces in package</b>	Taping	1P2T, 1P3T, 1P4T : 2,500 pcs./reel 2P2T : 1,400 pcs./reel

## OUTLINE DIMENSIONS

### ● CUS-12B

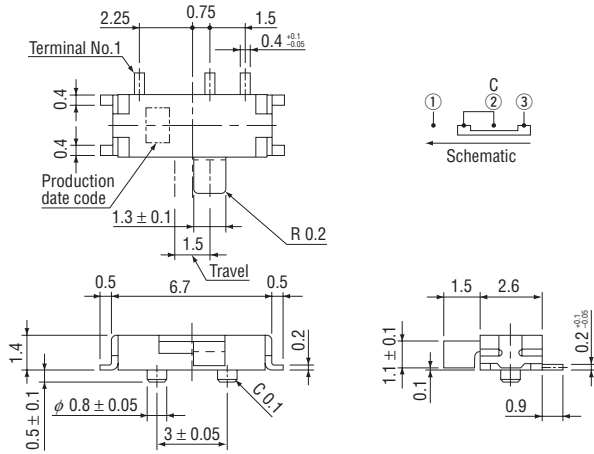

### ● CUS-13B

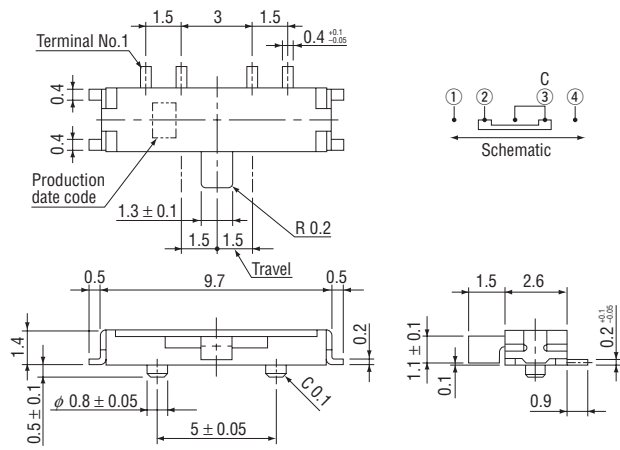

### ● CUS-14B

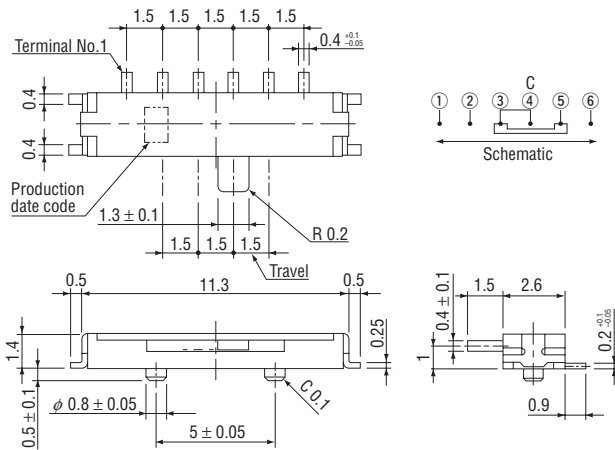

### ● CUS-22B

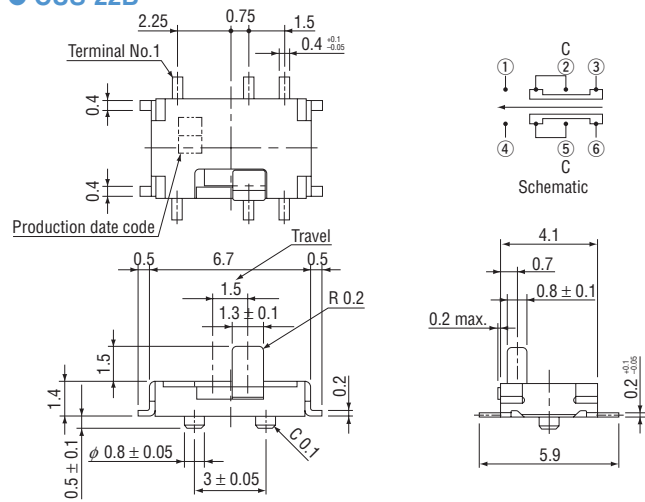

## RECOMMENDED P.C.B. PAD OUTLINE DIMENSIONS

### ● 1P2T

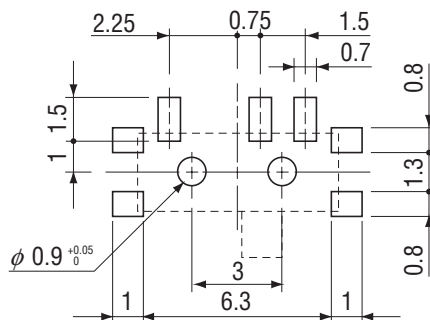

### ● 1P3T

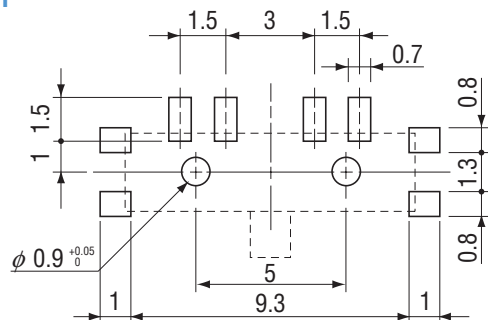

### ● 1P4T

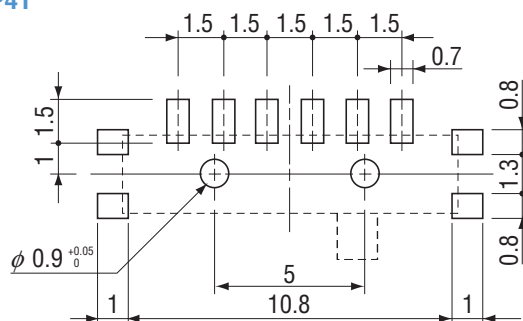

### ● 2P2T

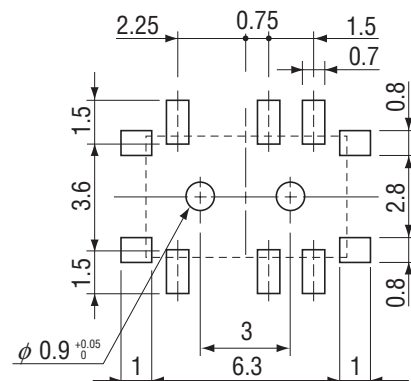

## PACKAGING SPECIFICATIONS

Taping version is packaged in 2500 pcs. per reel (1400 pcs. for CUS-22).

Taping version is boxed with 1 reel (2500 pcs. or 1400 pcs.). Maximum number of consecutive missing pieces = 2. Leader length and reel dimension are shown in the diagrams below.

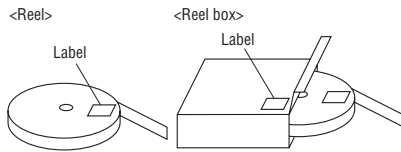

- Reel & embossed tape materials  
Embossed tape : Plastic  
Reel : Plastic
- Embossed tape pull strength  
10 N {1.02 kgf} minimum

### ● Embossed tape dimensions

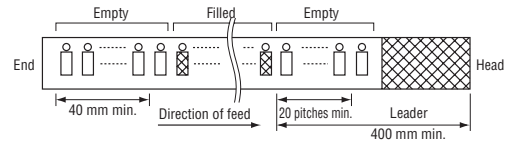

### ● Test method for peeling strength of seal tape

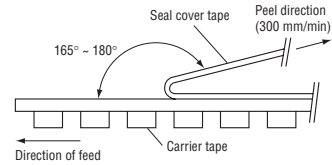

Peeling strength of seal tape :

0.1 ~ 1.3 N {10.2 ~ 132.7gf}  
{ } : Reference only

### ● CUS-12TB

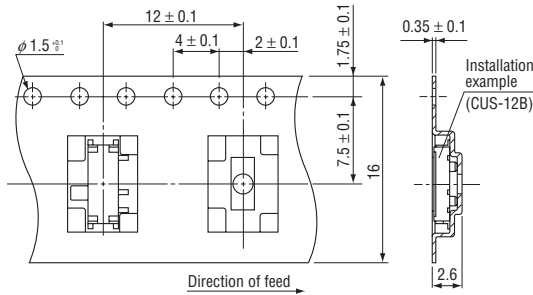

### ● CUS-13TB, CUS-14TB

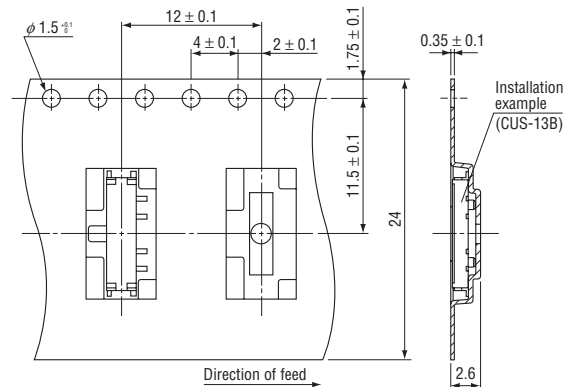

### ● CUS-22TB

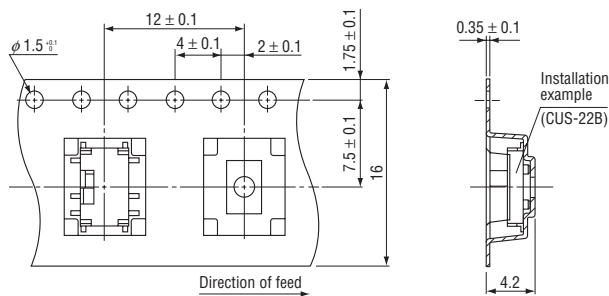

<Reel dimensions>

(Unit : mm)

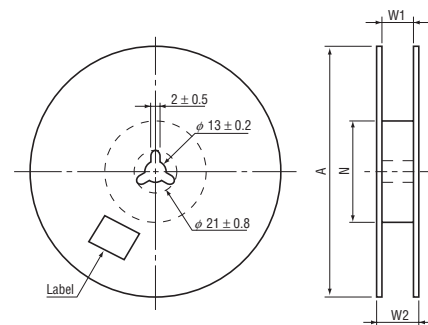

Part number	A	W <sub>1</sub>	W <sub>2</sub>	N
12TB, 22TB	φ 330 ± 2	17.4 ± 1	21.4 ± 1	φ 80 ± 1
13TB, 14TB	φ 330 ± 2	25.4 ± 1	29.4 ± 1	φ 80 ± 1

## SOLDERING CONDITIONS

- Manual soldering 350 °C 3 s maximum

