

REV.	DESCRIPTION	DATE
B	Updated rating	3/6/2007
C	added contact resistance	8/20/2010
D	added pin designations	9/15/2010

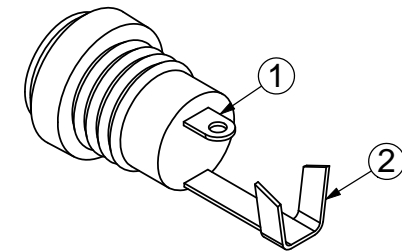
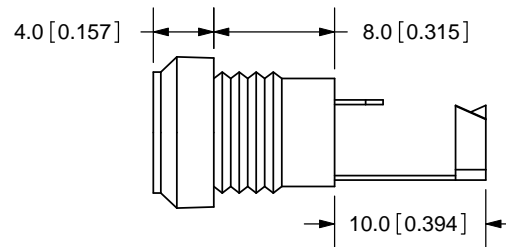
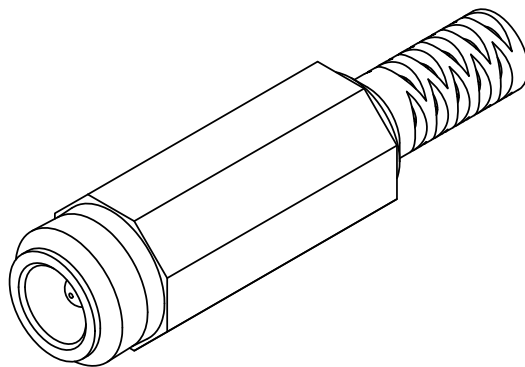
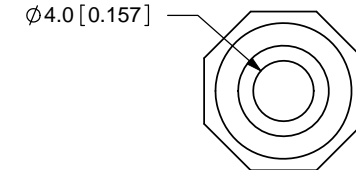
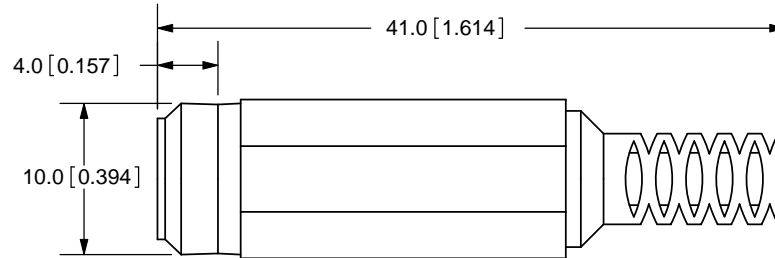
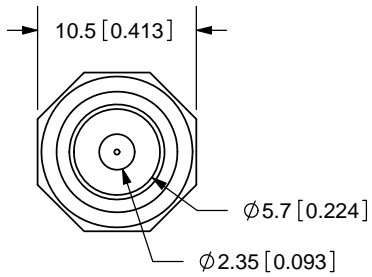
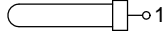
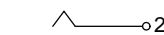

TOLERANCE:  
±0.3mm

**SPECIFICATIONS:**  
 RATING: 24V DC @ 4A  
 CONTACT RESISTANCE: 50m OHMS MAX  
 INSULATION RESISTANCE: 100M OHMS MIN: 500V DC  
 VOLTAGE WITHSTAND: 500V AC R.M.S. FOR 1 MINUTE  
 LIFE: 5,000 CYCLES

MODEL NO.	PR-002B
SCHEMATIC	 1
	 2

CENTER PIN DIAMETER 2.35mm Dia.

	MATERIAL	PLATING
CONTACT PIN	PBS	Nickel
CAP	PE	
TERMINAL 1	BSR	Nickel
TERMINAL 2	BSR	Nickel
PIN	BSBM	Nickel
RING	BSBM	Nickel
BODY	PA	



20050 SW 112th Ave.  
 Tualatin, OR 97062  
 Phone: 503-612-2300  
 800-275-4899  
 Fax: 503-612-2383  
 Website: www.cui.com

TITLE: DC POWER PLUGS		REV: D
PART NO. PR-002B	UNITS: MM [INCHES]	
DRAWN BY: ZRJ	APPROVED BY:	SCALE: 2:1

PC FILE NAME:  
PR-002B

COPYRIGHT 2010 BY CUI INC.