

Specifications
 Rated Voltage: 16VDC
 Rated Current: 300MA
 Contact Resistance: 100 mOHMS or less under all conditions including after life testing.
 Insulation Resistance: 100 M OHMS or greater at 500VDC.
 Dielectric Withstand Voltage: 250VAC RMS for 1 minute.
 Life: 5,000 cycles min.

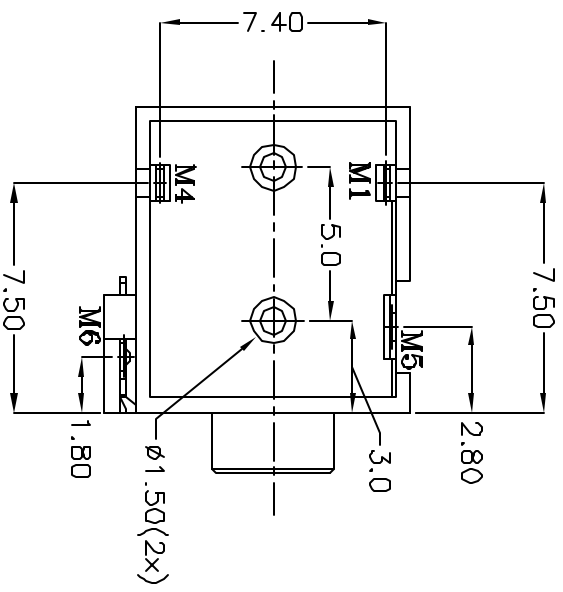

Bottom View

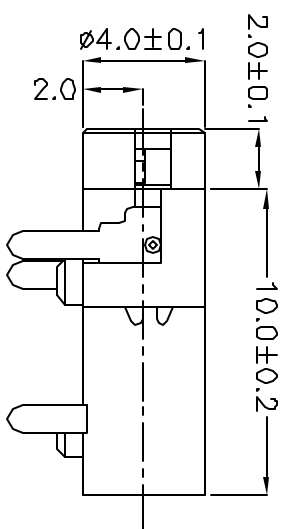
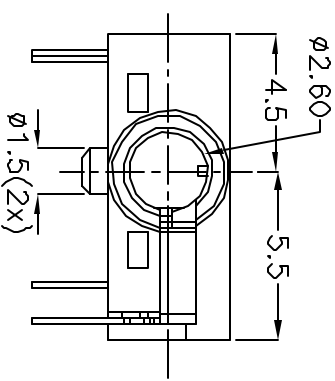
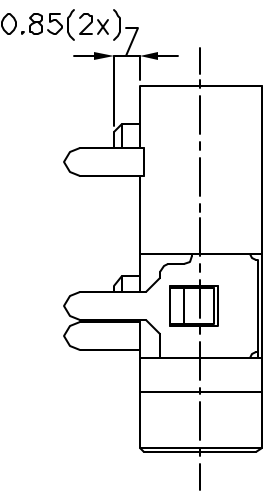
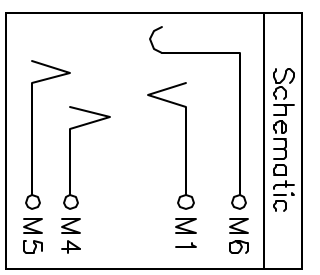
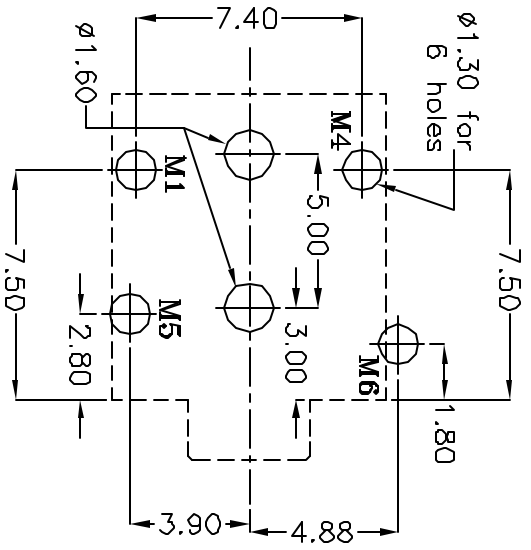

PC Board Layout
Top View

Item	Name	Material	Finish	Qty	Note
6	Ground(M6)	PBS	Au	1	3OT
5	Extra Ring(M5)	PBS	Au	1	3OT
4	Tip Contact(M4)	Ti-Cu	Au	1	2OT
3	Ring Contact(M1)	Ti-Cu	Au	1	2OT
2	Cover(P2-ST)	PY6T		1	UL-94V-0
1	Housing(P1-LCP)	LCP		1	UL-94V-0

CUI INC
 9815 SW Allen, Suite 103
 Beaverton, OR 97005
 Phone: (503) 643-4899
 800-276-4899
 Fax: (503) 372-1266
 Website: www.cui.com

TITLE: 2.5mm Audio Jack w/4 Conductors
 PART NO. SJ-42514 UNITS: Millimeters

DRAWN BY: Todd R. White APPROVED BY: SCALE: 4x