

Specifications
 Rated Voltage: 16VDC
 Rated Current: 300mA
 Contact Resistance: 100 mOHMS or less under all conditions including after life testing.
 Insulation Resistance: 100 M OHMS or greater at 500VDC
 Voltage: 250V AC RMS for 1 Minute
 Life: 5,000 cycles min.

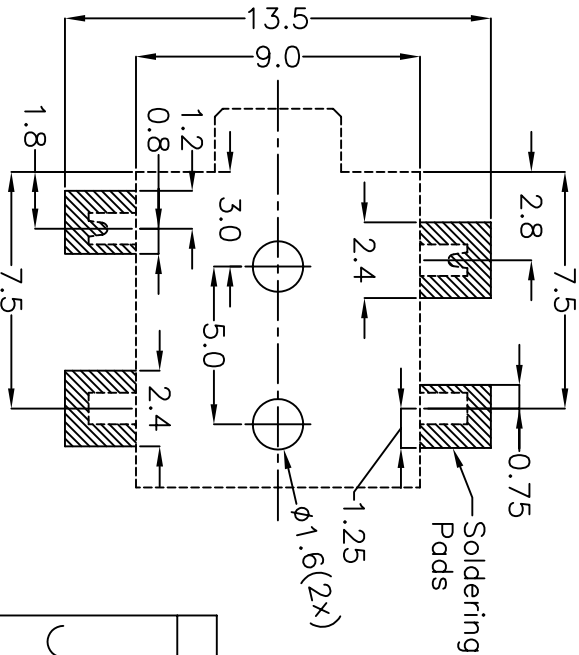

Pad Layout
Top View

6	Ground<M6>	PBS		Gold Flash 30T
5	Signal<M5>	PBS		Gold Flash 30T
4	Tip Contact<M4>	Ti-Cu Alloy		Gold Flash 20T
3	Ring Contact<M1>	Ti-Cu Alloy		Gold Flash 20T
2	Cover	PY6T	Black	UL94V-0 Rated
1	Plastic Housing<P1>	Polyamide	Black	UL94V-0 Rated
lm	Term	Material	Color	Plating Remark

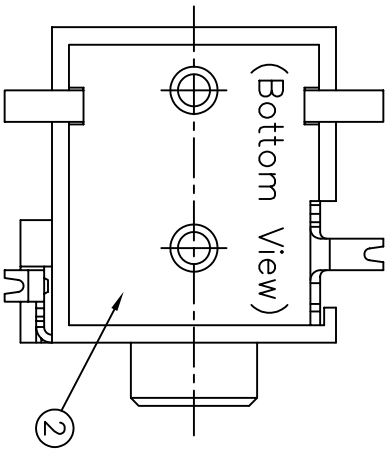
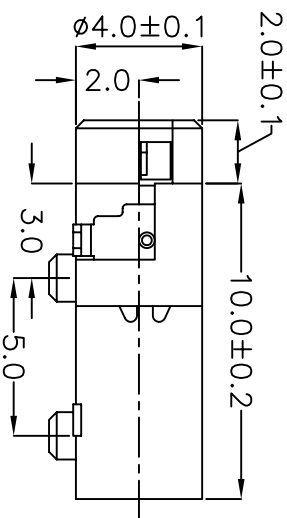
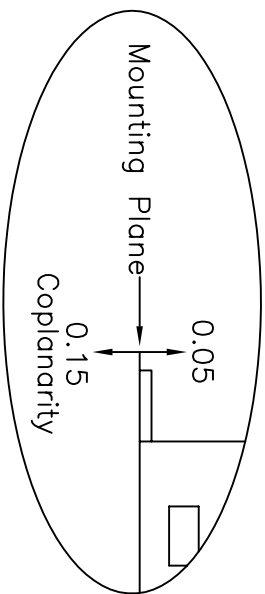
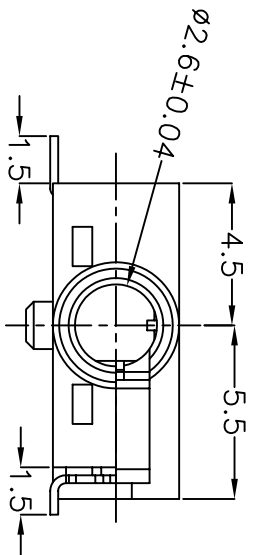
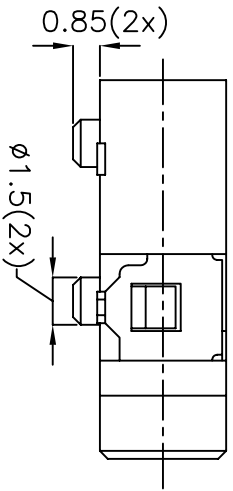
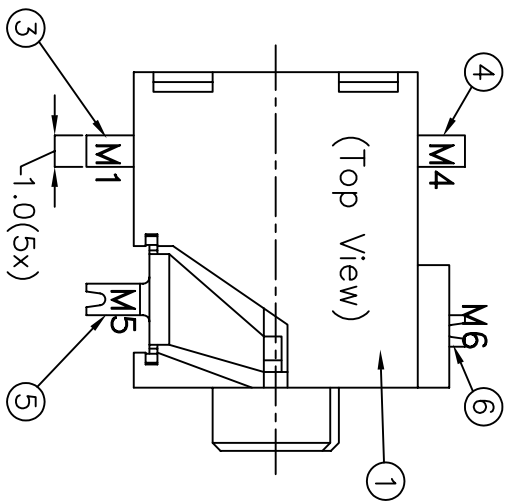
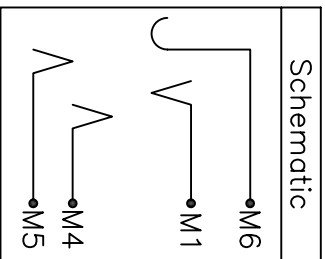

9615 SW Allen, Suite 103
 Beaverton, OR 97005
 Phone: (503) 643-4899
 800-275-4899
 Fax: (503) 372-1266
 Website: www.cui.com

TITLE: SMT Audio Jack w/4 Conductors 2.5mm

PART NO. SJ-42514-SMT UNITS: Millimeters

DRAWN BY: Todd R. White APPROVED BY: SCALE: 4x