

MODEL: CMS-34348N | **DESCRIPTION:** SPEAKER**FEATURES**

- miniature speaker
- 380 Hz resonant frequency
- Nd-Fe-B magnet

**SPECIFICATIONS**

| parameter | conditions/description | min | typ | max | units |
|-------------------------|--|-----|-----|--------|--------------------|
| input power | maximum power: IEC-60268-5, filter 60s on/120s off, 10 cycles at room temp | | 3.0 | 4.0 | W |
| impedance | at 1.0 kHz, 1.0 V | 6.8 | 8 | 9.2 | Ω |
| resonant frequency (Fo) | at 1.0 V | 304 | 380 | 456 | Hz |
| frequency response | output SPL -10 dB | Fo | | 10,000 | Hz |
| sound pressure level | at 1.0 W, 0.5 m ave, at 0.8, 1.0, 1.2, 1.5 kHz | 77 | 80 | 83 | dB |
| | at 3.0 W, 0.5 m ave, at 0.8, 1.0, 1.2, 1.5 kHz | 82 | 85 | 88 | dB |
| distortion | at 1.0 kHz, 1.0 W | | | 5 | % |
| buzz, rattle, etc. | must be normal at sine wave between Fo ~ 20,000 Hz | | 4.9 | | V |
| dimensions | 34 x 34 x 14.5 | | | | mm |
| magnet | Nd-Fe-B | | | | |
| material | ABS77D | | | | |
| cone material | mylar | | | | |
| terminal | solder terminals | | | | |
| weight | | | 30 | | g |
| operating temperature | | -20 | | 55 | $^{\circ}\text{C}$ |
| storage temperature | | -30 | | 65 | $^{\circ}\text{C}$ |
| RoHS | yes | | | | |

Notes: 1. All specifications measured at 5~35 $^{\circ}\text{C}$, humidity at 45~85%, under 86~106 kPa pressure, unless otherwise noted.

SOLDERABILITY

| parameter | conditions/description | min | typ | max | units |
|----------------|------------------------|-----|-----|-----|--------------------|
| hand soldering | for maximum 3 seconds | 370 | 380 | 390 | $^{\circ}\text{C}$ |

MECHANICAL DRAWING

units: mm
tolerance: ±0.5 mm

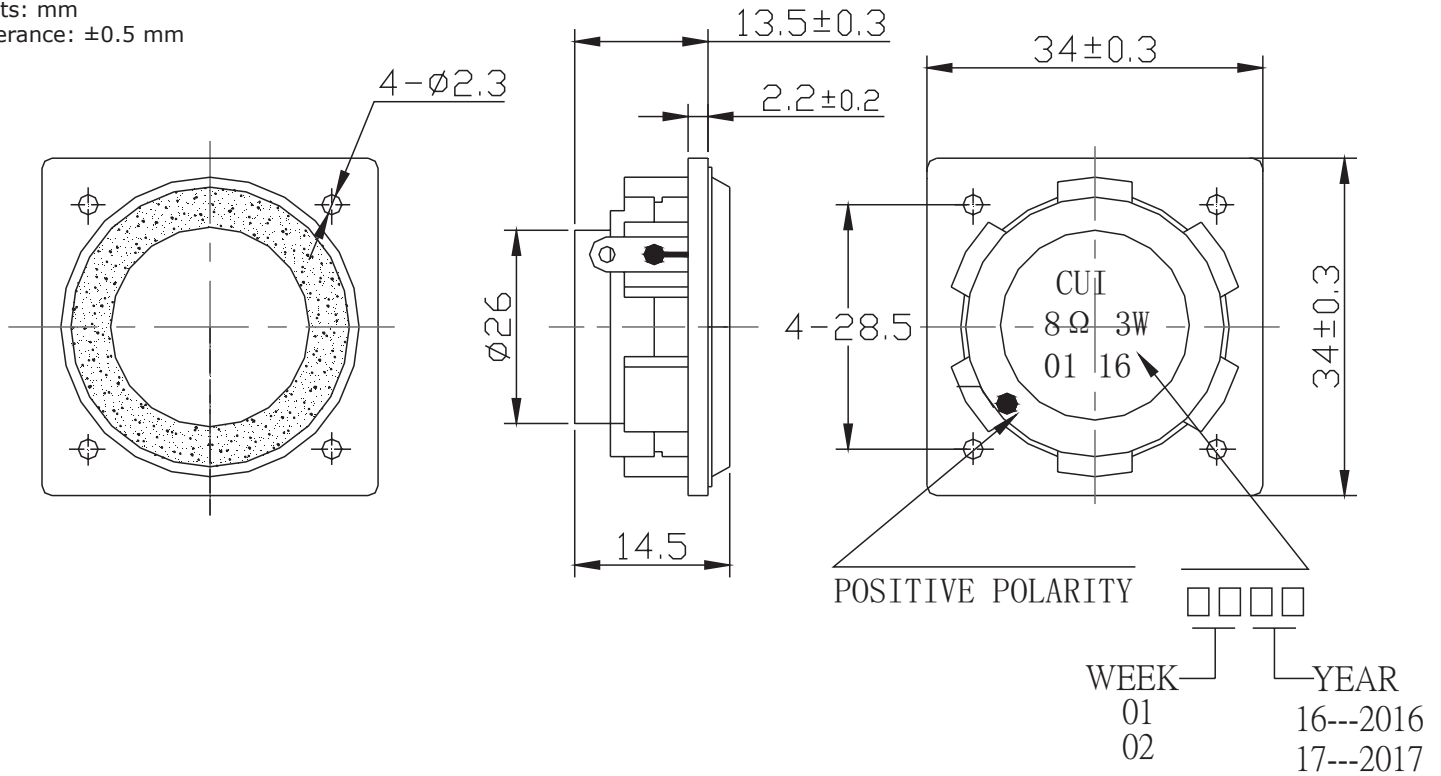

FREQUENCY RESPONSE CURVE

Frequency Response.Magn dB re 20.00µ PA AT 1 W / 0.5 m

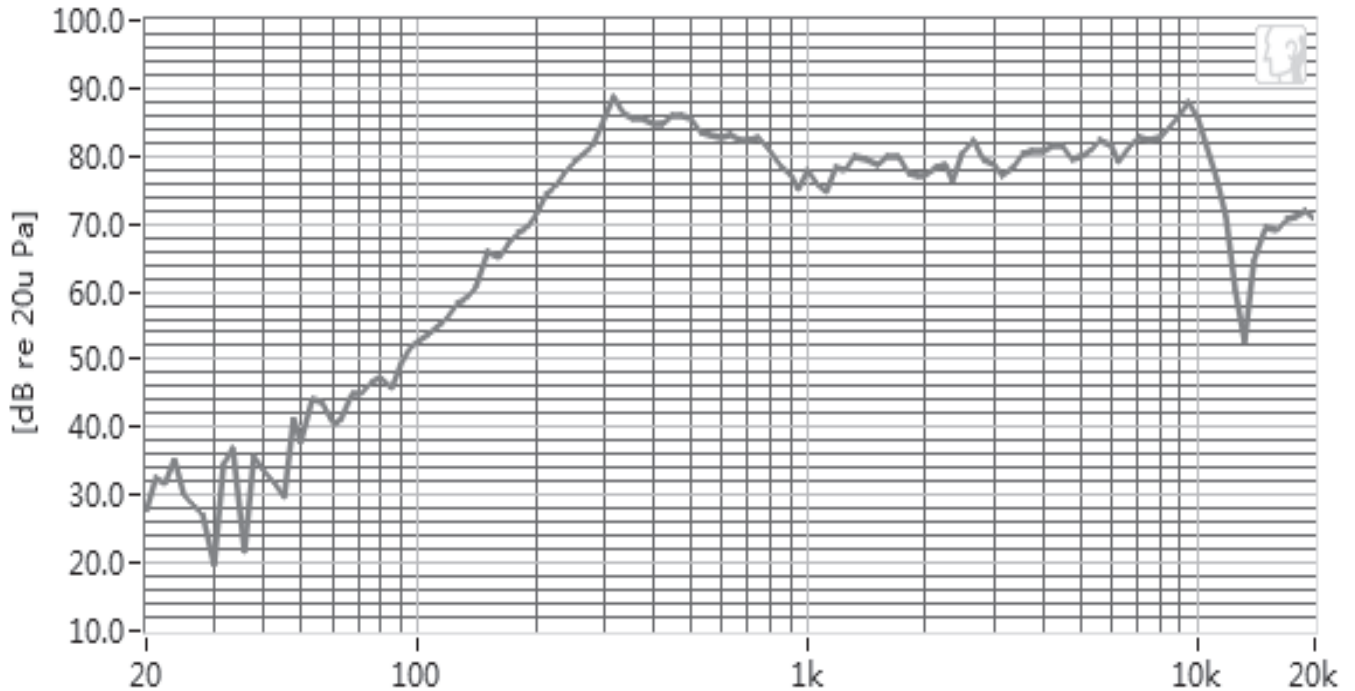

PACKAGING

units: mm

Tray Size: 400 x 200 x 18 mm
 Carton Size: 420 x 215 x 275 mm
 Tray QTY: 20 pcs per tray
 Carton QTY: 280 pcs per carton

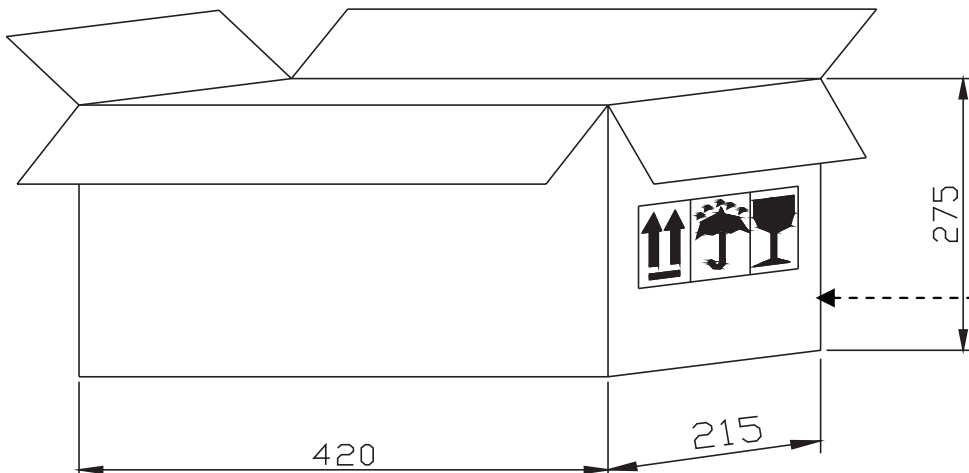
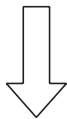
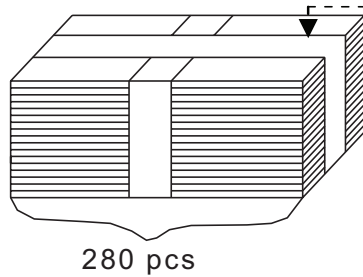
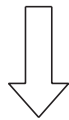
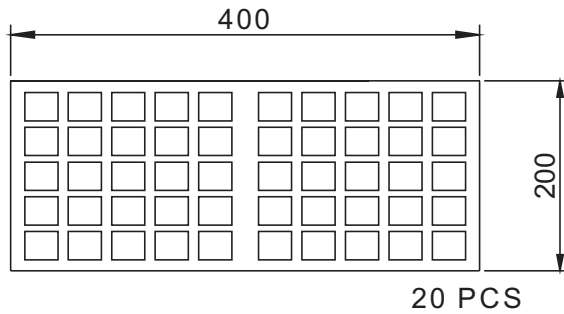

| | |
|-----------|--|
| Lot No. | XXXXXXXXXX |
| Model No. | CUI Inv#. XXXXXXXXXXXX CUI Part#. XXXXXXXXXXXX |
| Quantity. | XXXX Pcs |
| Date: | DD MM YY  |
| | MADE IN CHINA |
| | CUI Inc |

* The label stucked on inner boxes and the outer of carton.

REVISION HISTORY

| rev. | description | date |
|------|-----------------|------------|
| 1.0 | initial release | 06/28/2016 |
| 1.01 | brand update | 01/23/2020 |

The revision history provided is for informational purposes only and is believed to be accurate.

CUI DEVICES

CUI Devices offers a one (1) year limited warranty. Complete warranty information is listed on our website.

CUI Devices reserves the right to make changes to the product at any time without notice. Information provided by CUI Devices is believed to be accurate and reliable. However, no responsibility is assumed by CUI Devices for its use, nor for any infringements of patents or other rights of third parties which may result from its use.

CUI Devices products are not authorized or warranted for use as critical components in equipment that requires an extremely high level of reliability. A critical component is any component of a life support device or system whose failure to perform can be reasonably expected to cause the failure of the life support device or system, or to affect its safety or effectiveness.