

MODEL: PJ-097H | **DESCRIPTION:** DC POWER JACK**FEATURES**

- 8 A rating
- shielded
- panel mount
- 3 conductor
- signal pin

**SPECIFICATIONS**

parameter	conditions/description	min	typ	max	units
rated input voltage			24		Vdc
rated input current	power pin signal pin			8.0 1.0	A A
contact resistance ¹	between terminal and mating plug between terminal in a closed circuit			50 30	mΩ mΩ
insulation resistance	at 500 Vdc between adjacent contacts	100			MΩ
voltage withstand	for 1 minute, 0.5 mA between adjacent contacts			500	Vac
insertion/withdrawal force		0.3		3	kg
operating temperature		-25		85	°C
life	at a rate of 24 cycles/minute		5,000		cycles
flammability rating	UL94V-0				
RoHS	yes				

Note: 1. When measured at a current of less than 100 mA/1 kHz
2. All specifications measured at 10~35°C, humidity at 45~85%, under standard atmospheric pressure, unless otherwise noted.

SOLDERABILITY

parameter	conditions/description	min	typ	max	units
hand soldering	for 3~4 seconds	340	350	360	°C

MECHANICAL DRAWING

units: mm
 tolerance:
 X.X ± 0.2 mm
 X.XX ± 0.10 mm
 X.XXX ± 0.050 mm

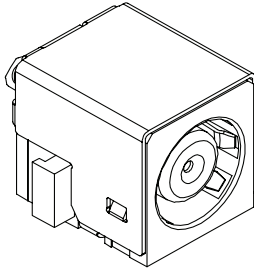

	MATERIAL	PLATING
terminal 1	copper alloy	gold flashed
terminal 2	copper alloy	gold flashed
terminal 3	copper alloy	gold flashed
shield	brass	nickel
insulator	PA10T	

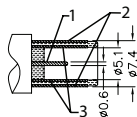
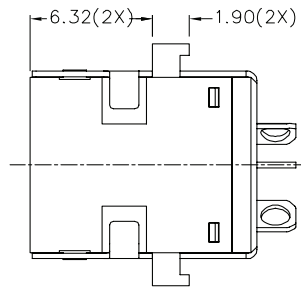
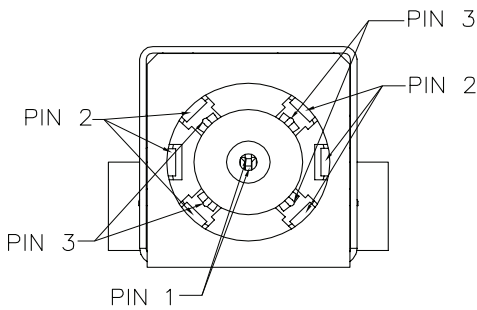
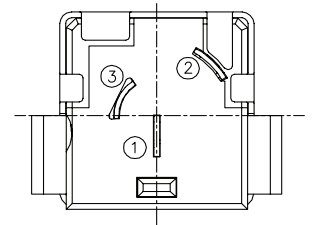
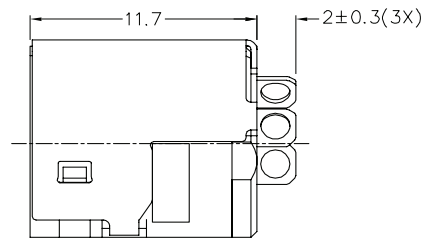
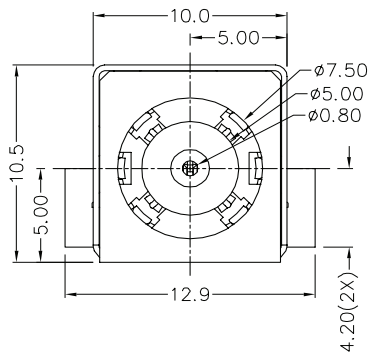

MATING PLUG
 Jack Insertion Depth: 9.2 mm

SCHEMATIC	3(V+)
	1(S)
	2(V-)
Model	PJ-097H
terminal 1	signal pin
terminal 2	outer sleeve
terminal 3	inner sleeve

REVISION HISTORY

rev.	description	date
1.0	initial release	12/17/2018
1.01	brand update	11/06/2019

The revision history provided is for informational purposes only and is believed to be accurate.

CUI DEVICES

CUI Devices offers a one (1) year limited warranty. Complete warranty information is listed on our website.

CUI Devices reserves the right to make changes to the product at any time without notice. Information provided by CUI Devices is believed to be accurate and reliable. However, no responsibility is assumed by CUI Devices for its use, nor for any infringements of patents or other rights of third parties which may result from its use.

CUI Devices products are not authorized or warranted for use as critical components in equipment that requires an extremely high level of reliability. A critical component is any component of a life support device or system whose failure to perform can be reasonably expected to cause the failure of the life support device or system, or to affect its safety or effectiveness.