

TOP VIEW

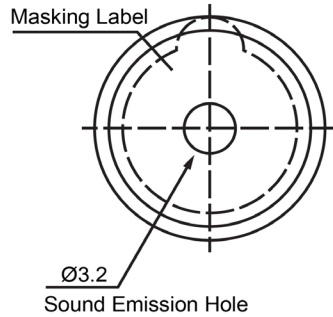

SIDE VIEW

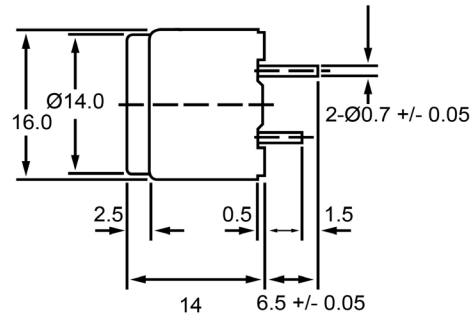

BOTTOM VIEW

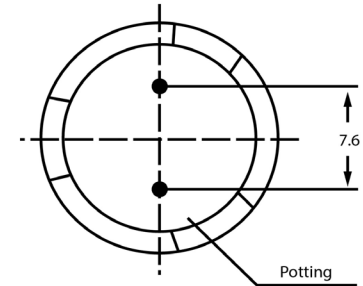

Specifications			Notes	Revision History					
Description	Value	Unit		Version	Description	Date	Approved		
Technology	Electro-Mechanical		1) All dimensions are in mm unless otherwise noted 2) All parts meet RoHS 	1	Released from Engineering	10/21/2013	J.S		
Resonant Frequency	2,300	(Hz)							
Rated Voltage	6	(V)							
SPL @ 10cm	85	(dBA)							
Tone	Single Tone								
Mount Type	Thru Hole								
Voltage Range	4 ~ 8	(V)							
Max Rated Current	30	(mA)							
Housing Material	NORYL								
Operating Temperature	-40 ~ +85	°C							
Storage Temperature	-40 ~ +85	°C							
Weight	7	(g)							
				Electro-Mechanical Indicator		IE162306-1			
				Drawn by A.B.	Date 10/21/2013	Checked by C.E.	Date 10/21/2013	Approved by J.S	Date 10/21/2013