

## NERGIZI

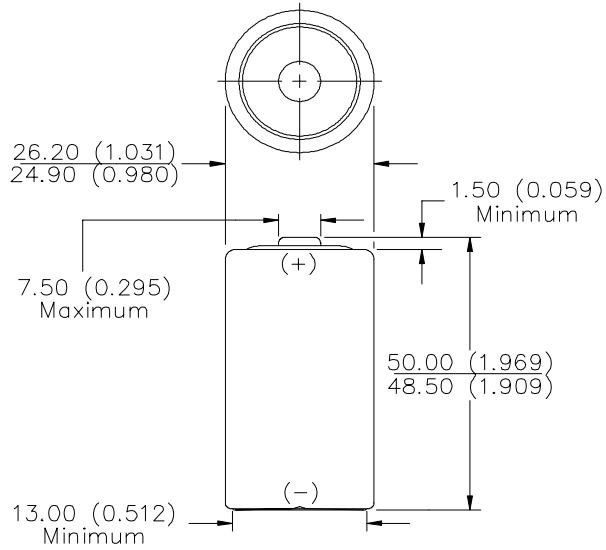

### SUPER HEAVY DUTY

**Chemical System:** Zinc-Manganese Dioxide (Zn/MnO<sub>2</sub>)  
(No Added Mercury or Cadmium)

**Designation:** ANSI-14D, IEC-R14

**Battery Voltage:** 1.5 Volts

**Operating Temp:** -18°C to 55°C (0°F to 130°F)

**Average Weight:** 45.0 grams (1.6 oz.)

**Volume:** 25 cubic centimeters (1.5 cubic inch)

**Average Capacity:** 3800 mAh to 0.8 volts  
(Rated at 25 mA continuous at 21°C)

**Cell:** One No. 35 (size "C")

**Jacket:** Metal

**TYPICAL TEMPERATURE EFFECT**  
3.9 ohm - 4 hours/day to 0.75 volts

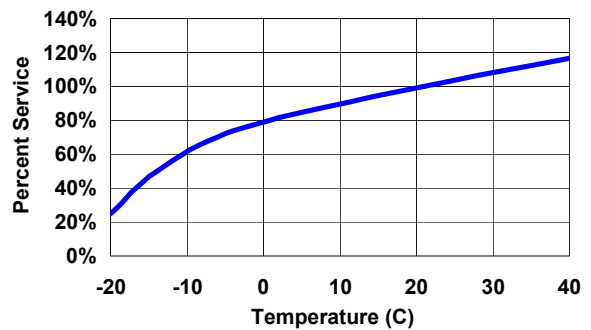

**CONSTANT RESISTANCE PERFORMANCE**  
Typical Service

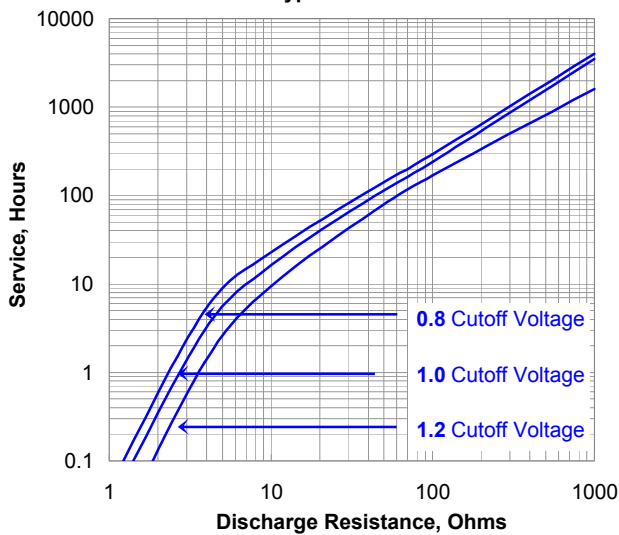

**CONSTANT CURRENT DISCHARGE**  
Typical Service

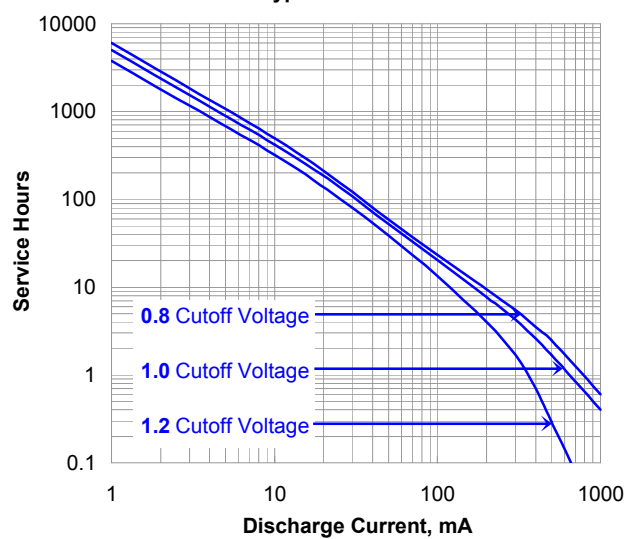

## ENERGIZER NO. 1235

### ANSI Industry Standard Tests @ 20° C

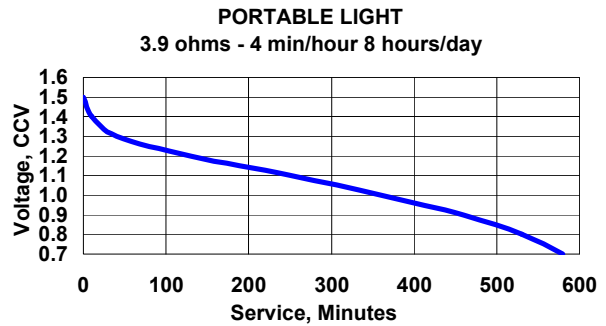
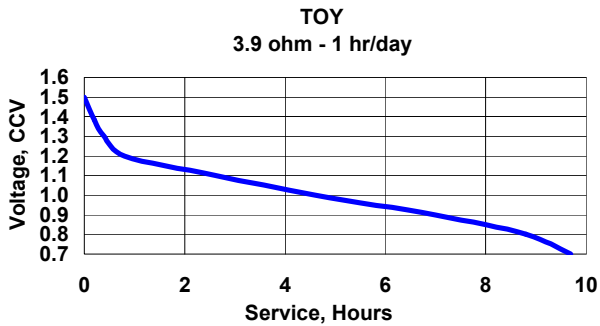
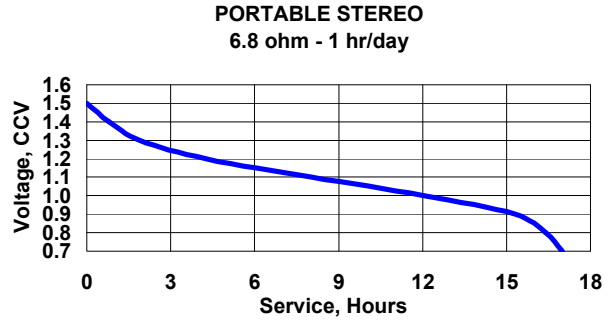
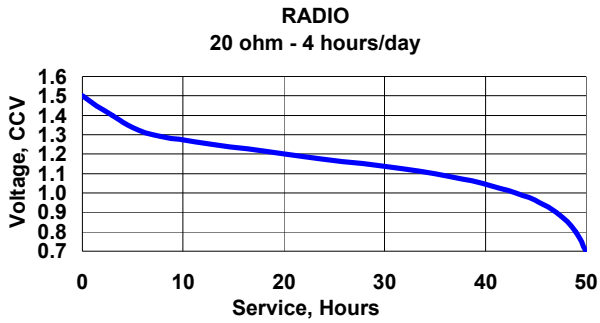

#### Important Notice

This data sheet contains information specific to batteries manufactured at the time of its publication.

**Contents herein do not constitute a warranty.**

Copyright © Eveready Battery Co. - All rights reserved