

# ZK4 PI-Spring Terminal Blocks Feed-through

Combine high performance with compact dimensions:

- 1000 V IEC 600 V UL,
- Opt for the best marking visibility thanks to the up-front, flat marker zone, which lets you mark up to eight digits or increase the font size.

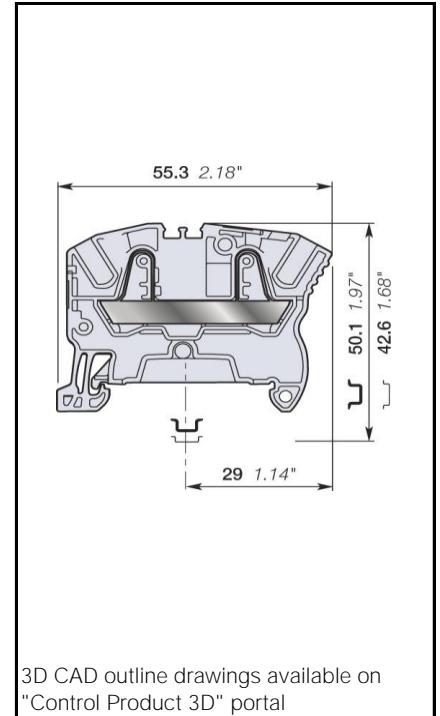
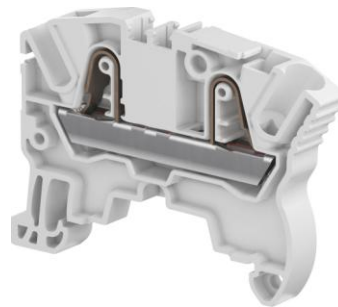

	PI-Spring Terminal Blocks	4 mm <sup>2</sup>
		10 AWG
6 mm 0.236 in Spacing		

### Ordering Details

Color	Type	Order Code	EAN Code	Pack <sup>(ing)</sup>	Weight (1 pce)	g
Grey	ZK4	1SNK706010R0000	3472597060106	50		7.9
Blue	ZK4-BL	1SNK706020R0000	3472597060205	50		7.9
Orange	ZK4-OR	1SNK706030R0000	3472597060304	50		7.9

### Declarations and Certificates

CE	CB	RoHS	USR CNR		Gost R	ATEX	IECEX	
							ATEX Declaration	

## Declarations and Certificates





	CE	1SND225150C10*
	CB	1SND162016A02*
	RoHs	1SND230535F02*
	USR CNR	1SND162012A02*
	CSA	1SND162014A02*
	GOST R	1SND161005A11*
	ATEX	1SND162009A17*
	IECEX	1SND162010A17*
	BV	1SND162013A02*
Atex Declaration	Atex Declaration	1SND225085C10*

## Explosive Atmosphere: ATEX Classification

Group Category	Protection Method
IM2 II 2 GD Ex eb I/IC/IIIC	Ex e: increased security
In the presence of explosive dust atmosphere, terminal blocks are to be installed in certified enclosure II 2D	

## General Information

The following information must be strictly adhered to in order to guarantee the terminal block electrical, mechanical and environmental performance.

Protection	IEC 60947-1	IP20	NEMA250				
Rail		TH 35-7.5, TH 35-15					
Wire stripping length		12.5 mm	0.492 in				
		Screw clamp	Screw rail contact (Maximum value)	Disconnect device			
Operating tool		Flat screwdriver					
Torque		3.5 mm	0.138 in				

## Material Specifications

Insulating material	Polyamide
CTI	600 V
Flammability	UL94 V0
	NF F 16101 I2F2
	Needle flame test.C 60615-11-5 Compliant

## Connecting capacity per clamp

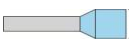
		PI Spring			
1 Rigid - Solid / Stranded conductor	Norme	IEC60947-7-1	UL1059		
	Value	0.5 ... 6 mm <sup>2</sup>	26 ... 10 AWG		
1 Flexible conductor	Norme	IEC60947-7-1			
	Value	0.5 ... 4 mm <sup>2</sup>			
1 Flexible conductor with non insulated ferrule	Norme	Manufacturer data	Manufacturer data		
	Value	0.5 ... 4 mm <sup>2</sup>	26 ... 12 AWG		
1 Flexible conductor with insulated ferrule	Norme	Manufacturer data	Manufacturer data		
	Value	0.5 ... 4 mm <sup>2</sup>	26 ... 12 AWG		
Gauge			2.9 mm		
		IEC 60947-1			
Ferrule maximum outer diameter or conductor insulation maximum outer diameter		∅ Max.	Manufacturer data	5.35 mm	

The "Connecting capacity with ferrule" data is guaranteed with ABB crimping tool PS-3 (crimping capacity up to 10 mm<sup>2</sup>).

As part of its on-going product improvement, ABB reserves the right to modify the characteristics or the products described in this document. The information given is not contractual. For further details please contact the ABB company marketing these products in your country.

## Multi Connecting capacity per clamp

2 Rigid - Solid / Stranded conductors	Norme			
	Value			
2 Flexible conductors	Norme			
	Value			
2 Flexible conductors with twin ferrule	Norme	Manufacturer data	Manufacturer data	
	Value	0.5 ... 1 mm <sup>2</sup>	26 ... 18 AWG	

Don't mix solid and flexible conductors in the same clamp

Don't mix solid or flexible conductors of different sizes in the same clamp

The "Connecting capacity with ferrule" data is guaranteed with ABB crimping tool PS-3 (crimping capacity up to 10 mm<sup>2</sup>)

## Cross section

Rated cross section	IEC60947-7-1	4 mm <sup>2</sup>	UL1059	10 AWG
Maximum Cross section	Manufacturer data	6 mm <sup>2</sup>	Manufacturer data	10 AWG

## Electrical characteristics

### Current

Rated current		IEC60947-7-1	32 A
	Field and factory wiring Cat.2	UL 1059	30 A
	Factory wiring Cat.1	UL 1059	
		CSA-C-22.2 n°158	30 A
Maximum Exe current		IEC/EN 60079-7	29 A
Rated short-time withstand current 1 s (I <sub>cw</sub> )		IEC60947-7-1	480 A
Short-time withstand current	0.5 s	Manufacturer data	
	5 s	Manufacturer data	
	10 s	Manufacturer data	
	30 s	Manufacturer data	
	1 min	Manufacturer data	
Rated short-circuit withstand current		CSA-C-22.2 n°158	
Max. current (45° temperature increase) / Max. cross section (mm <sup>2</sup> )		Manufacturer data	40 A   6 mm <sup>2</sup>
Maximum short circuit current (1s)		Manufacturer data	480 A

## Short Circuit Current Rating (SCCR) SA UL 1059 supplement

SCCR		UL 1059	100 kA
With the following configurations:			
	Suitable conductor wire range		10 AWG
	Maximum voltage		600 V
	Fuse class / Max. amp. Rating	J	175 A
		T	175 A
		RK1	100 A
		RK5	60 A
		G	60 A
		CC	30 A

## Voltage

Rated voltage	IEC 60947-1	1000 V
Rated voltage	UL 1059	600 V
Use Group	UL 1059	B, C, D
Rated voltage	CSA-C-22.2 n°158	600 V
Rated voltage Ex e	IEC/ EN 60079-7	630 V
Rated impulse withstand voltage	IEC 60947-1	8000 V
Dielectric test voltage	IEC 60947-1	2200 V
Pollution degree	IEC 60947-1	3
Overvoltage category	IEC 60947-1	III

## Temperature range

Ambient temperature min/max	Storage	-55 ... +110 °C	-67 ... +230 °F
	Installing	-5 ... +40 °C	-23 ... +104 °F
	Service	-55 ... +110 °C	-67 ... +230 °F

Current Derating curve for continuous service temperature

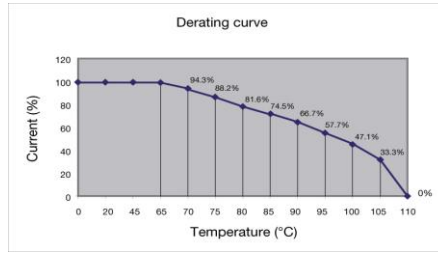

## Dissipated power

Maximum dissipated power at rated current	IEC 60947-1	1 W
Maximum dissipated power at maximum Exe current	IEC 60079-7	0.9 W

## Rated power dissipation at an ambient temperature of 23 °C - IEC 60947-7-3

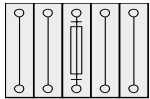
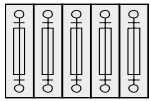
Separate arrangement / Overload and short-circuit protection	 <p>1 fuse and 4 feed-through blocks</p>	
Separate arrangement / Exclusive short-circuit protection		
Compound arrangement / Overload and short-circuit protection	 <p>5 fuse blocks</p>	
Compound arrangement / Exclusive short-circuit protection		

## Environmental Characteristics

### Additional climatic tests

Dry heat	Conditions	IEC 60068-2 2	Compliant
		Temperature	110 °C
		Duration of test	96 h
Cyclic damp heat	Conditions	IEC 60068-2 30	Compliant
		Temperature	55 °C
		Relative humidity	95 %
		Number of cycles (1 cycle = 24h)	2
Cold	Conditions	IEC 60068-2 1	Compliant
		Temperature	-55 °C
		Duration of test	96 h
Damp heat steady state	Conditions	IEC 60068-2 78	Compliant
		Temperature	40 °C
		Relative humidity	93 %
		Duration of test	96 h

## Corrosion

Salt mist	Conditions	IEC 60068-2 11	Compliant
		Duration of test	1000 h
		Concentration	5 %
SO <sub>2</sub>	Conditions	ISO 6988	Compliant
		Duration of test	48 h
		Concentration	0.2 dm <sup>3</sup>
Flowing mixed gas corrosion test	Conditions	IEC 60068-2 60	Compliant
		Number of the test method	3
		Duration of test	21 j

As part of its on-going product improvement, ABB reserves the right to modify the characteristics or the products described in this document. The information given is not contractual. For further details please contact the ABB company marketing these products in your country.

## Vibrations and shocks

Sinusoidal vibrations		IEC 60068-2-6	Compliant
	Conditions	Frequency range	5 ... 100 Hz
		Number of cycles	1
		Acceleration	7 m/s <sup>2</sup>
Functional random vibrations		IEC 61373	Compliant
Category 1 Class B 3 axes	Conditions	Duration of test	20 mn
		Frequency range	5 ... 150 Hz
		Acceleration	1 m/s <sup>2</sup>
Long life testing at increased random vibrations		IEC 61373	Compliant
Category 1 Class B 3 axes	Conditions	Duration of test	5 h
		Frequency range	5 ... 150 Hz
		Acceleration	5.7 m/s <sup>2</sup>
Shock		IEC 61373	Compliant
Category 1 Class B 3 axes	Conditions	Duration of test	30 ms
		Acceleration	5 G

## ZK4 Terminal Block Accessories Compatibility

Some accessories may modify the terminal block's rating. See complete information in the accessories catalog page.

Description	Type	Order Code	Pack <sup>(ing)</sup> pieces	Weight g (1 pce)
1 End Stops	BAM3	1SNK900001R0000	50	13.80
	BAZ1	1SNK900002R0000	20	5.30
	BAZH1	1SNK900102R0000	20	23.90
2 End Sections	EK2.5	1SNK705910R0000	20	1.8
3 Jumper Bars	JB6-2	1SNK906302R0000	50	1.30
	JB6-3	1SNK906303R0000	50	2.10
	JB6-4	1SNK906304R0000	50	2.90
	JB6-5	1SNK906305R0000	50	3.60
	JB6-10	1SNK906310R0000	20	7.40
	JB6-50	1SNK906350R0000	10	38.10
4 Circuit Separators	CS-R2	1SNK900106R0000	20	3.8
	CS-R3	1SNK900107R0000	20	6.4
5 Test Adapters	TP2	1SNK900203R0000	20	1.73
	TP4	1SNK900205R0000	20	2.41
6 Test Connectors	TC5-R1	1SNK900201R0000	10	5.23
7 Spacers	ES-TC6	1SNK900105R0000	10	0.80
8 Mounting Rails	PR3.G2	1SNA164800R0300	2	
	PR4	1SNA168500R1200	2	915.00
	PR5	1SNA168700R2200	2	
	PR30	1SNA173220R0500	2	328.00
	PR3.Z2	1SNA174300R1700	2	
	PR50	1SNA178529R0400	2	1 288.00
9 Tools	PS-3	1SNK900650R0000	1	380.00
10 Terminal Block Markers	MC512	1SNK140000R0000	22	9.00
	MC512-YL	1SNK140004R0000	22	9.00
	MC512PA	1SNK149999R0000	20	10.00
	MC612	1SNK150000R0000	22	10.00
	MC612-YL	1SNK150004R0000	22	10.00
	MC612PA	1SNK159999R0000	20	11.00
	PROCAP5	1SNK900609R0000	20	0.69
	UMH	1SNK900611R0000	10	0.20
	PROCAP6	1SNK900612R0000	20	0.78
	SAT6	1SNK900615R0000	5	6.00

As part of its on-going product improvement, ABB reserves the right to modify the characteristics or the products described in this document. The information given is not contractual. For further details please contact the ABB company marketing these products in your country.

# Contact us

ABB France  
Low Voltage Products Division  
Export Department  
10, rue Ampère Z.I. - B.P. 114  
F-69685 Chassieu cedex / France  
Tel. +33 (0)4 7222 1722  
Fax +33 (0)4 7222 1935

#### Note

*We reserve the right to make technical changes or modify the contents of this document without prior notice. With regard to purchase orders, the agreed particulars shall prevail. ABB does not accept any responsibility whatsoever for potential errors or possible lack of information in this document.*

*We reserve all rights in this document and in the subject matter and illustrations contained therein. Any reproduction, disclosure to third parties or utilization of its contents – in whole or in parts – is forbidden without prior written consent of ABB.*

Copyright© 2011 ABB  
All rights reserved

1SNK162045D0201 - PDF