

UNCONTROLLED DOCUMENT

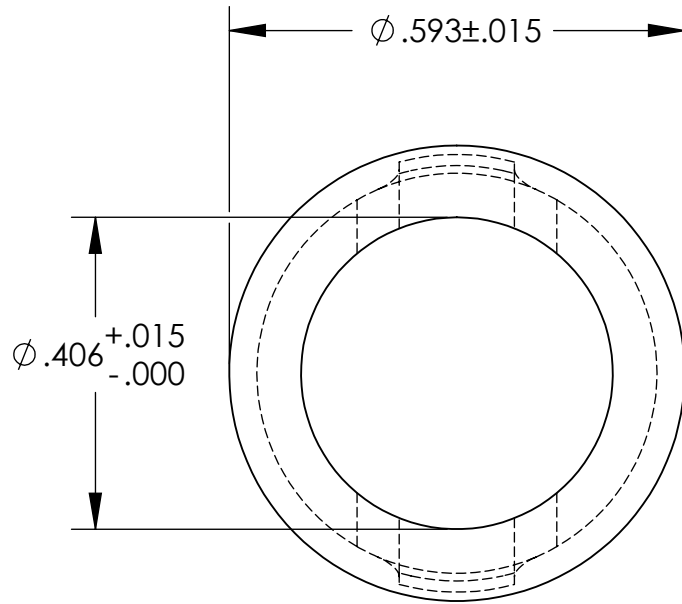

NOTES:
HOLE SIZE: .531
MAXIMUM PANEL THICKNESS: 1/16"
MATERIAL: HEAT STABILIZED NYLON 6; BLACK

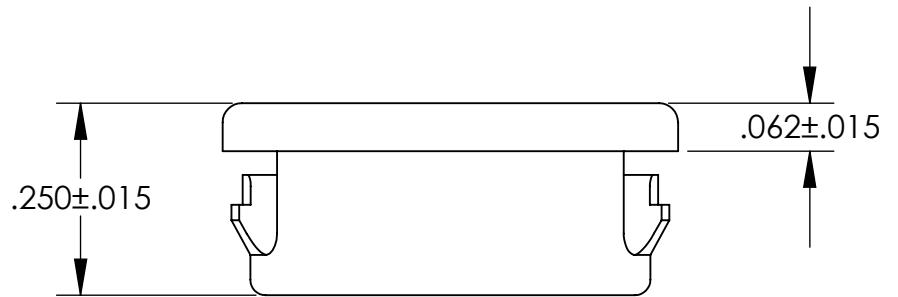
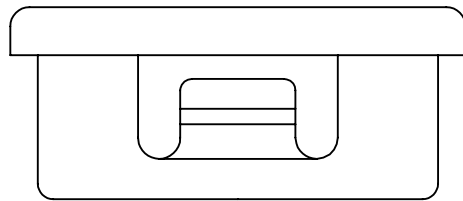

TOLERANCES UNLESS NOTED

- ±.005 ON DIMENSIONS THRU .625
- ±.008 ON DIMENSIONS .626 THRU 1.000
- ±.010 ON DIMENSIONS 1.001 THRU 1.500
- ±.015 ON DIMENSIONS LARGER THAN 1.500
- ±.015 ON FRACTIONAL DIMENSIONS

**WE RESERVE THE RIGHT
TO DISCONTINUE ITEMS,
CHANGE SPECIFICATIONS
OR DESIGN AT ANY TIME
WITHOUT NOTICE AND
WITHOUT INCURRING
ANY OBLIGATIONS**

PROPERTY OF
MICRO PLASTICS INC.

CATALOG DRAWING
MINIATURE INSULATING BUSHING
MICRO P/N 22MP01040
DWG. # 22MP01040
FILE SERVER\ENG\WEB

MATERIAL: AS NOTED

DATE

SCALE
1:1

JDD