

UNCONTROLLED DOCUMENT

NOTES:
HOLE SIZE: .750
MAXIMUM PANEL THICKNESS: .125
MATERIAL: HEAT STABILIZED NYLON 6; BLACK

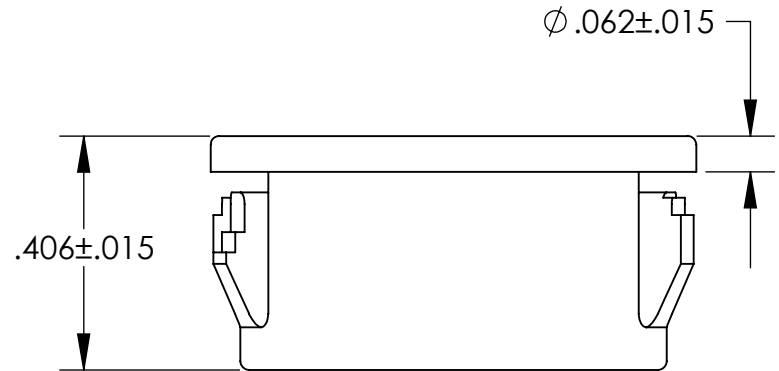
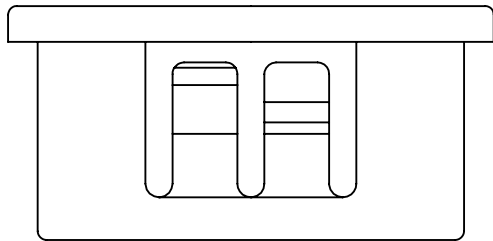
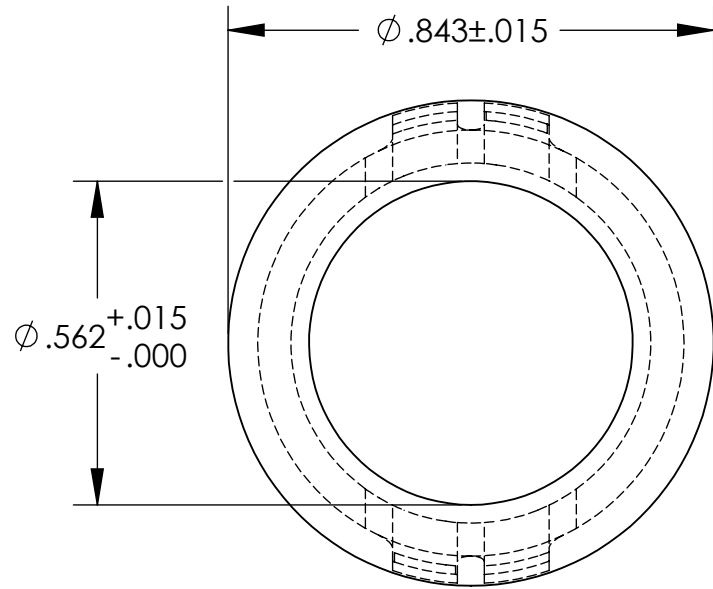

TOLERANCES UNLESS NOTED

- $\pm .005$ ON DIMENSIONS THRU .625
- $\pm .008$ ON DIMENSIONS .626 THRU 1.000
- $\pm .010$ ON DIMENSIONS 1.001 THRU 1.500
- $\pm .015$ ON DIMENSIONS LARGER THAN 1.500
- $\pm .015$ ON FRACTIONAL DIMENSIONS

**WE RESERVE THE RIGHT
TO DISCONTINUE ITEMS,
CHANGE SPECIFICATIONS
OR DESIGN AT ANY TIME
WITHOUT NOTICE AND
WITHOUT INCURRING
ANY OBLIGATIONS**

PROPERTY OF
MICRO PLASTICS INC.

CATALOG DRAWING
STANDARD INSULATING BUSHING
MICRO P/N 22MP07509
DWG. # 22MP07509
FILE SERVER\ENG\WEB

MATERIAL: AS NOTED

DATE

SCALE
3:1

JDD