

UNCONTROLLED DOCUMENT

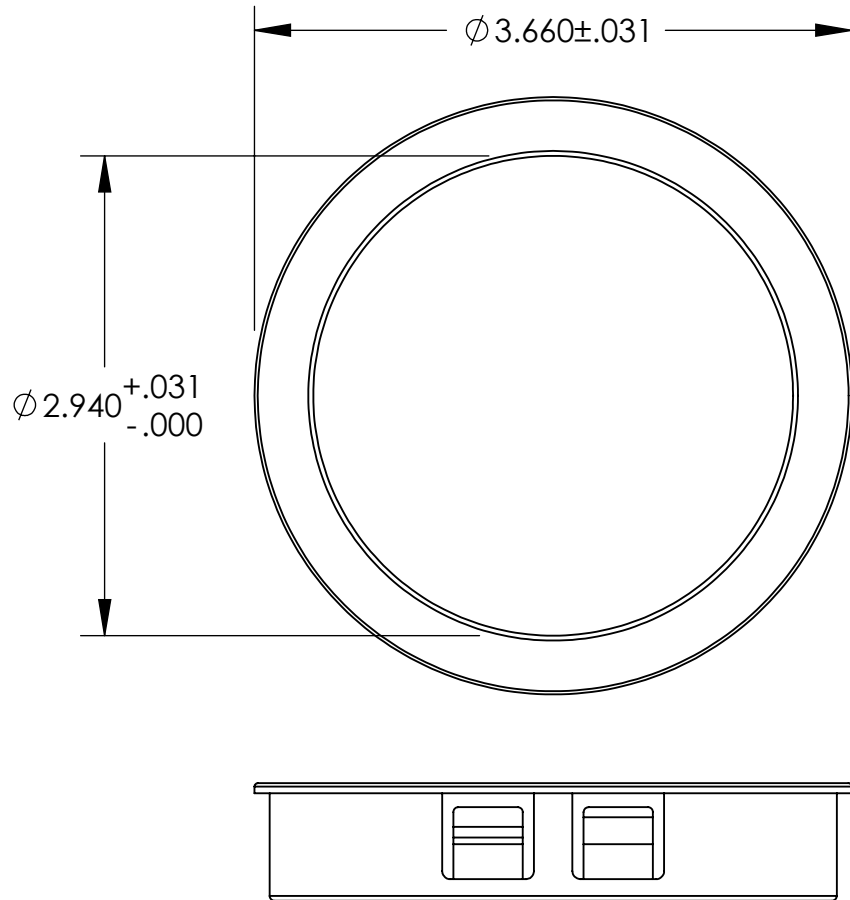

NOTES:
 HOLE SIZE: 3.500
 MAXIMUM PANEL THICKNESS: .250

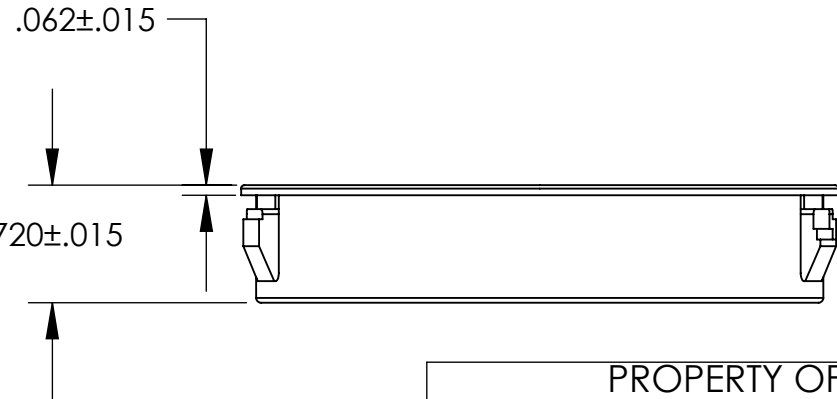

TOLERANCES UNLESS NOTED

- $\pm .005$ ON DIMENSIONS THRU $.625$
- $\pm .008$ ON DIMENSIONS $.626$ THRU 1.000
- $\pm .010$ ON DIMENSIONS 1.001 THRU 1.500
- $\pm .015$ ON DIMENSIONS LARGER THAN 1.500
- $\pm .015$ ON FRACTIONAL DIMENSIONS

WE RESERVE THE RIGHT
 TO DISCONTINUE ITEMS,
 CHANGE SPECIFICATIONS
 OR DESIGN AT ANY TIME
 WITHOUT NOTICE AND
 WITHOUT INCURRING
 ANY OBLIGATIONS

PROPERTY OF
MICRO PLASTICS INC.

CATALOG DRAWING
 STANDARD INSULATING BUSHING
 MICRO P/N 22MP35047
 DWG. # 22MP35047
 FILE SERVER\ENG\WEB

MATERIAL: HEAT STABILIZED NYLON BLACK

DATE	SCALE 0.85:1	TA
------	-----------------	-----------