

UNCONTROLLED DOCUMENT

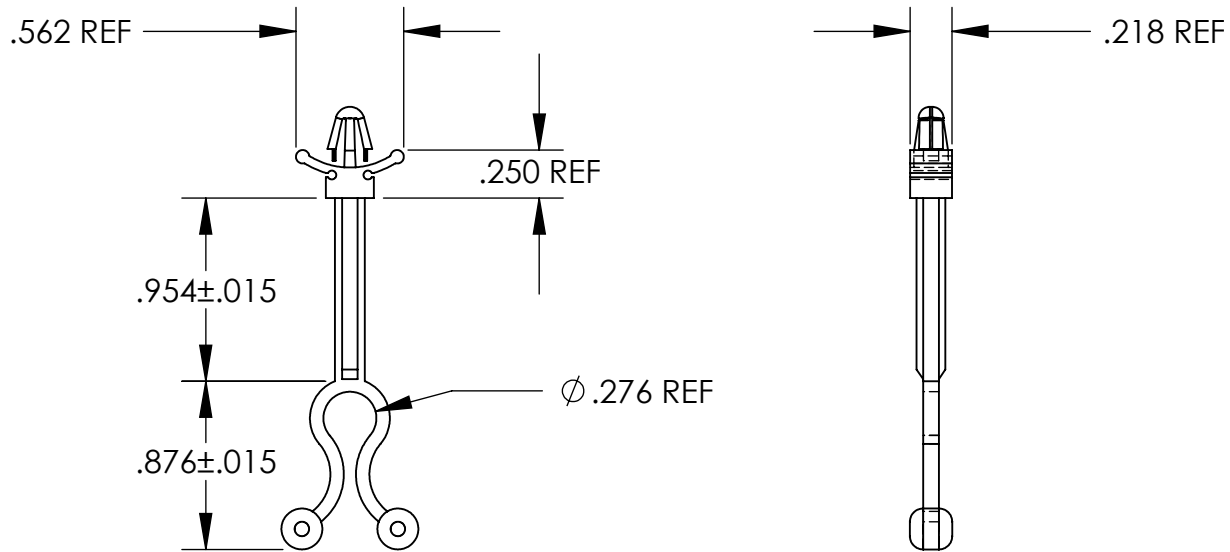

NOTES:
HOLE SIZE - .187
PANEL THICKNESS - .030/.078

TOLERANCES UNLESS NOTED

- $\pm .005$ ON DIMENSIONS THRU $.625$
- $\pm .008$ ON DIMENSIONS $.626$ THRU 1.000
- $\pm .010$ ON DIMENSIONS 1.001 THRU 1.500
- $\pm .015$ ON DIMENSIONS LARGER THAN 1.500
- $\pm .015$ ON FRACTIONAL DIMENSIONS

**WE RESERVE THE RIGHT
TO DISCONTINUE ITEMS,
CHANGE SPECIFICATIONS
OR DESIGN AT ANY TIME
WITHOUT NOTICE AND
WITHOUT INCURRING
ANY OBLIGATIONS**

PROPERTY OF
MICRO PLASTICS INC.

CATALOG DRAWING
"EZ" TL SUPPORT 187 DIA HOLE
MICRO P/N 23EZO250N0954
DWG. # 23EZO250N0954
FILE SERVER\ENG\WEB

MATERIAL: NYLON 6/6

DATE

SCALE
1:1

SD