

UNCONTROLLED DOCUMENT

NOTES:
HOLE SIZE .156
PANEL THICKNESS .062

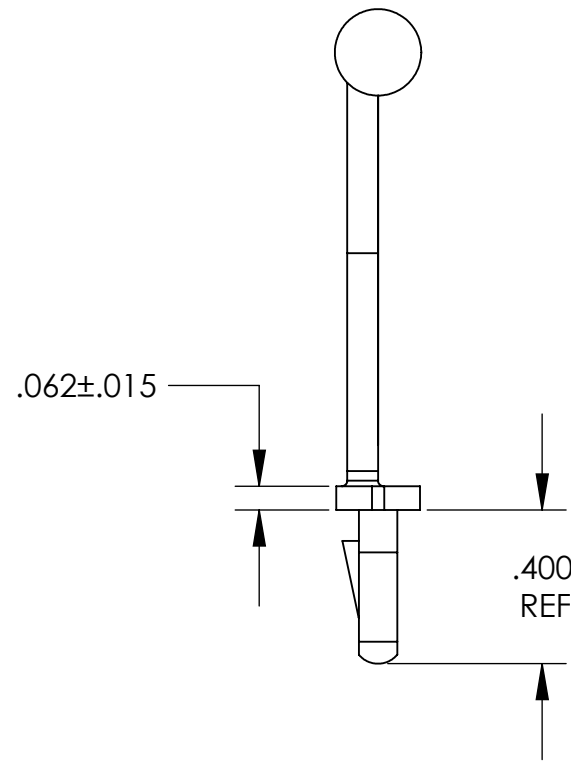
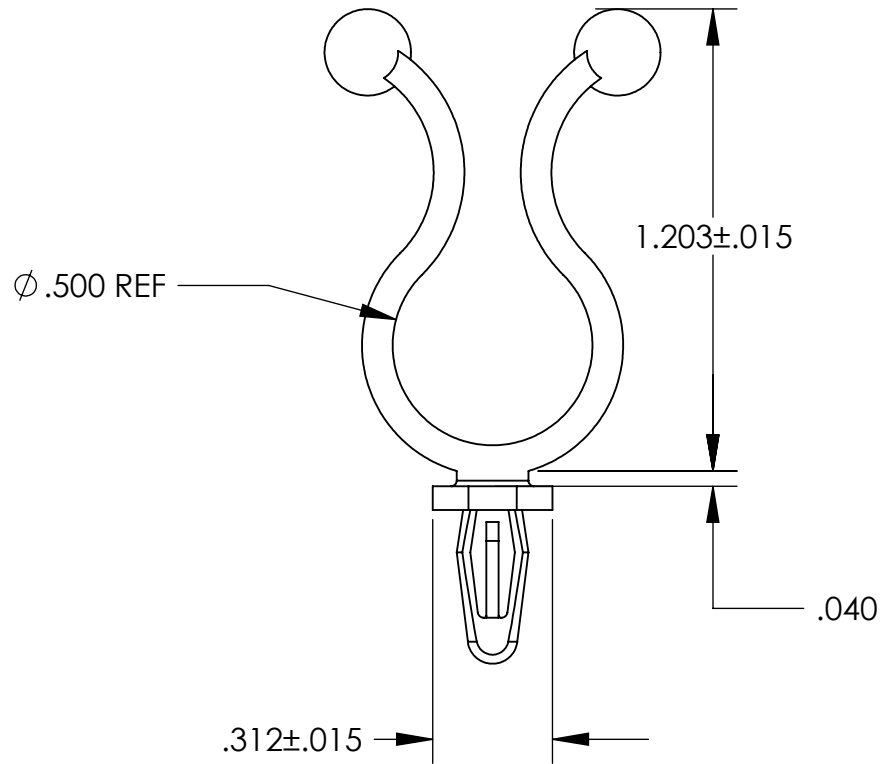

TOLERANCES UNLESS NOTED

- $\pm .005$ ON DIMENSIONS THRU $.625$
- $\pm .008$ ON DIMENSIONS $.626$ THRU 1.000
- $\pm .010$ ON DIMENSIONS 1.001 THRU 1.500
- $\pm .015$ ON DIMENSIONS LARGER THAN 1.500
- $\pm .015$ ON FRACTIONAL DIMENSIONS

**WE RESERVE THE RIGHT
TO DISCONTINUE ITEMS,
CHANGE SPECIFICATIONS
OR DESIGN AT ANY TIME
WITHOUT NOTICE AND
WITHOUT INCURRING
ANY OBLIGATIONS**

PROPERTY OF
MICRO PLASTICS INC.

CATALOG DRAWING
"EZ" TL SUPPORT 156 DIA HOLE
MICRO P/N 23EZO500C0040
DWG. # 23EZO500C0040
FILE SERVER\ENG\WEB

MATERIAL: NYLON 6/6

DATE

SCALE
2:1

SD