

Tous droits strictement réservés. Reproduction ou communication à des tiers interdite sous quelque forme que ce soit sans autorisation écrite du propriétaire. Propriété de FCI. Droits de reproduction FCI.

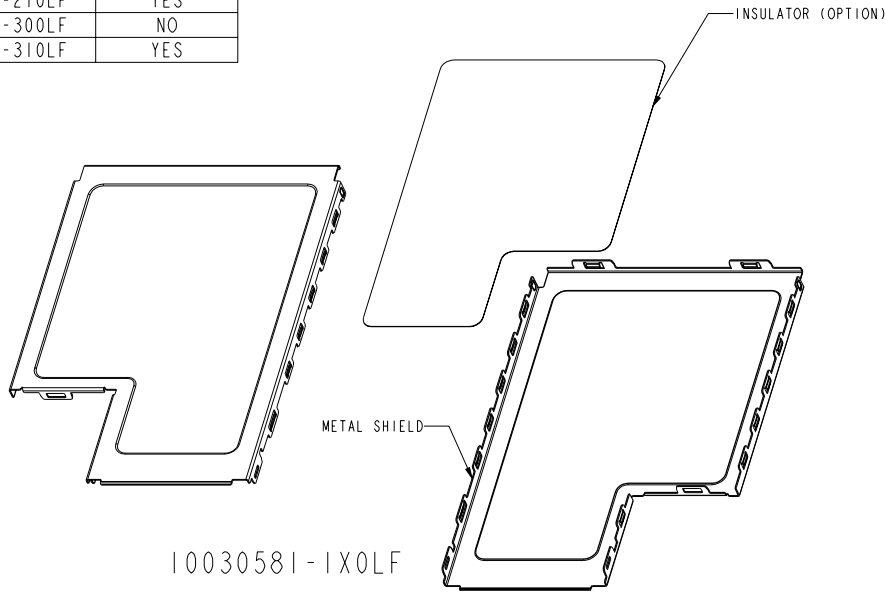

All rights strictly reserved. Reproduction or issue to third parties in any form whatever is not permitted without written authority from the proprietor. Property of FCI. Copyright FCI.

PRODUCT NO.	INSULATOR
10030581-100LF	NO
10030581-110LF	YES
10030581-200LF	NO
10030581-210LF	YES
10030581-300LF	NO
10030581-310LF	YES



10030581-1X0LF

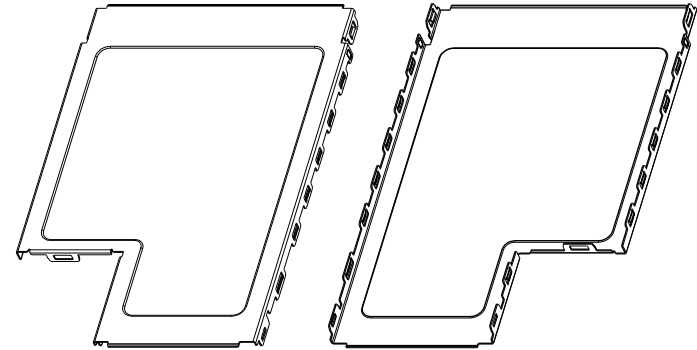

10030581-2X0LF

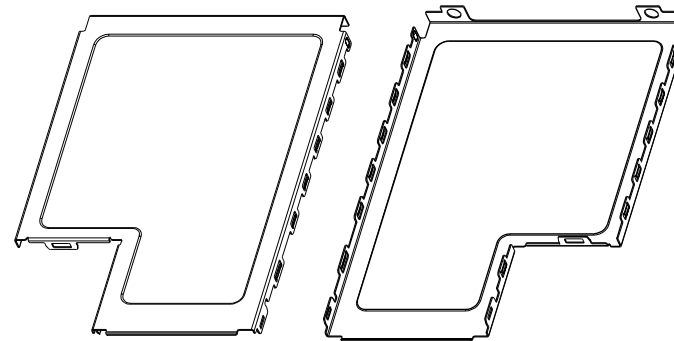

10030581-3X0LF

NOTES:

- MATERIAL PROPERTIES:  
METAL SHIELD : STAINLESS STEEL, SURFACE FINISH : MATTE.  
INSULATOR : POLYESTER FILM WITH ADHESIVE, 3M 1350 OR EQUIVALENT.

- PART NUMBER SCHEME:  
10030581- X X 0 L F

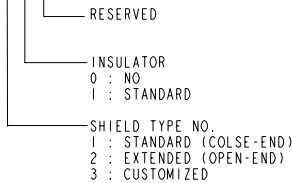

- PRODUCT PERFORMANCE PER SPEC. GS-12-292.
- PACKAGING SPEC. PER GS-14-927.

tolerance unless otherwise specified	
linear	.X ± .30 .XX ± .15 .XXX ± .08
angles	X° ± 2°

A FCI		www.fciconnect.com		tolerance	projection	size	Scale	
Dr	DAVID TENG	10/04/04	Product family	✓		A4	1.000	
Eng	DAVID TENG	10/04/04	Spec ref					
Chr	PAUL WANG	10/04/04	Material					
Appr	JOSEPH HSIA	10/04/04						
Title				EXPRESSCARD/54 MODULE CARD KIT TOP SHIELD SUB-ASSEMBLY		dwg no	10030581	Rev. E
catalog no				CUSTOMER DRAWING		sheet 1 of 4		

rev	ecn no	dr	date
A	T04-0382	D T	11/04/04
B	T05-0099	D T	05/09/05
C	T05-0152	D T	07/11/05
D	T05-0228	D T	10/18/05
E	T06-0015	D T	01/16/06

Tous droits strictement réservés. Reproduction ou communication à des tiers interdite sous quelque forme que ce soit sans autorisation écrite du propriétaire. Propriété de FCI. Droits de reproduction FCI.



All rights strictly reserved. Reproduction or issue to third parties in any form whatever is not permitted without written authority from the proprietor. Property of FCI. Copyright FCI.

PRODUCT NO.  
10030581-1X0LF

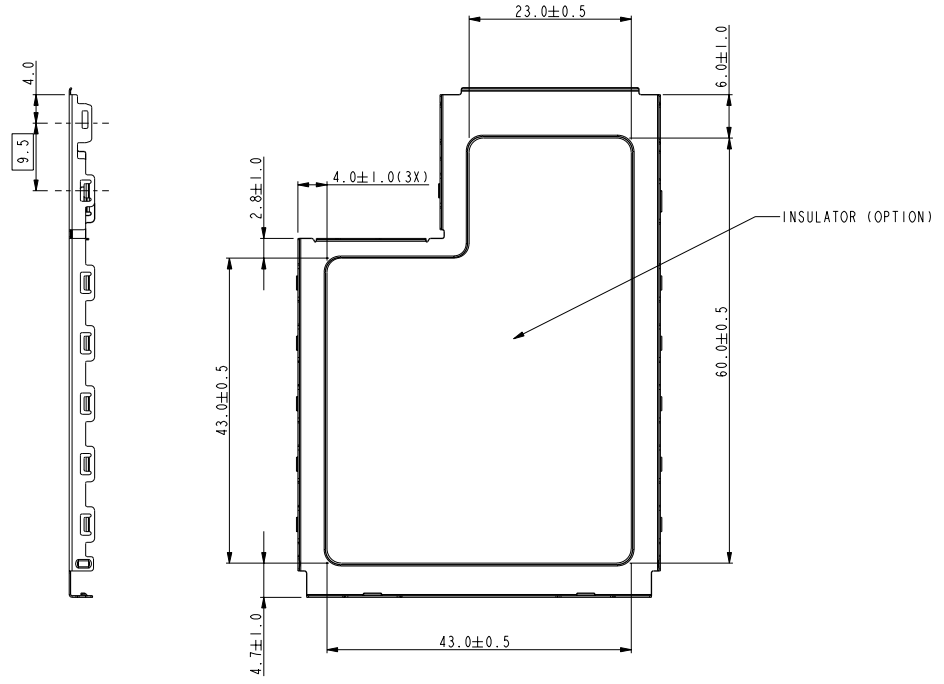
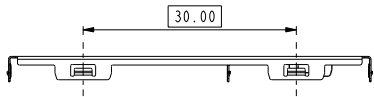
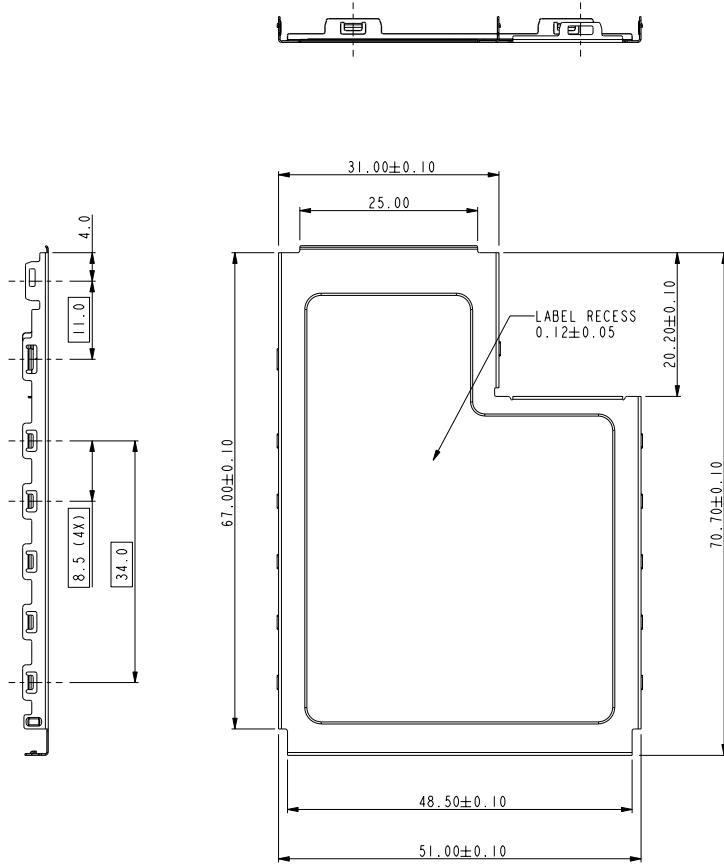

tolerance unless otherwise specified	
linear	.X ± .30
	.XX ± .15
	.XXX ± .08
angles	X° ± 2°

www.fciconnect.com		✓	tolerance	projection	MM
Dr	DAVID TENG	10/04/04	Product family	size	A4
Eng	DAVID TENG	10/04/04	Spec ref	Scale	1.000
Chr	PAUL WANG	10/04/04	Material	ECN	
Appr	JOSEPH HSIA	10/04/04			
Title			EXPRESSCARD/54 MODULE CARD KIT	dwg no	10030581
			TOP SHIELD SUB-ASSEMBLY	Rev.	E
catalog no			CUSTOMER DRAWING	sheet 2 of 4	



Tous droits strictement réservés. Reproduction ou communication à des tiers interdite sous quelque forme que ce soit sans autorisation écrite du propriétaire. Propriété de c FCI. Droits de reproduction FCI.

All rights strictly reserved. Reproduction or issue to third parties in any form whatever is not permitted without written authority from the proprietor. Property of FCI. Copyright FCI.

PRODUCT NO.  
10030581-2X0LF

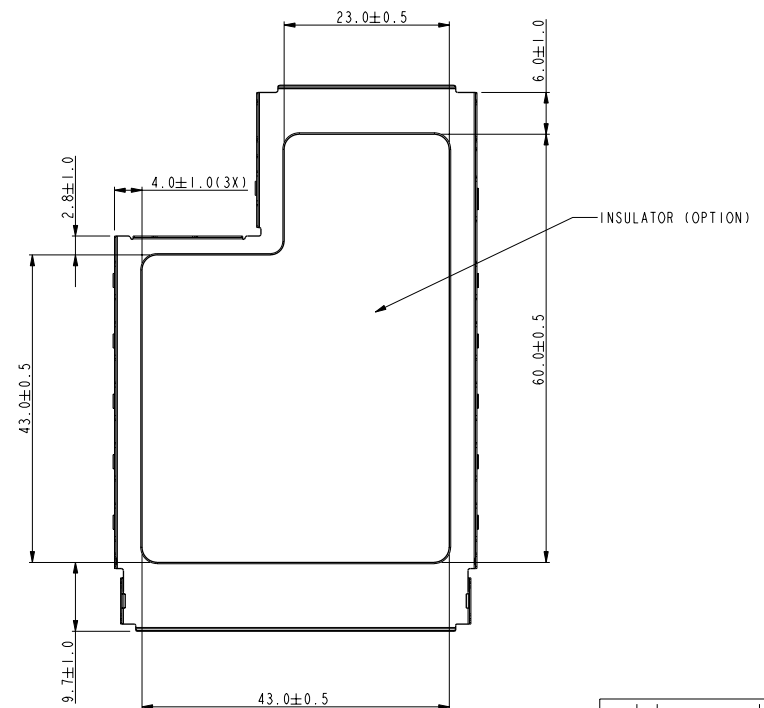
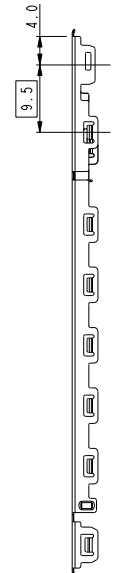
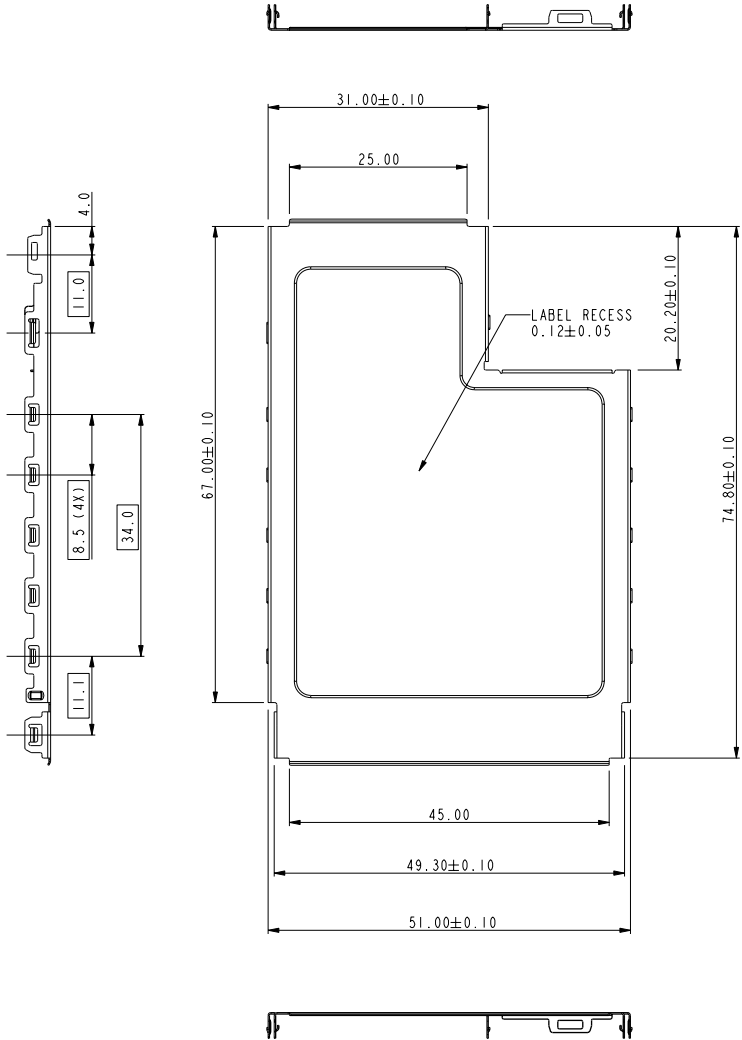

tolerance unless otherwise specified	
linear	.X ± .30
	.XX ± .15
	.XXX ± .08
angles	X° ± 2°

Dr	DAVID TENG	05/09/05	Product family	tolerance	projection	size	Scale
	Eng	DAVID TENG	05/09/05				
Chr	PAUL WANG	05/09/05	Material	✓	MM	ECN	
Appr	JOSEPH HISA	05/09/05					
Title			EXPRESSCARS/54 MODULE CARD KIT TOP SHIELD SUB-ASSEMBLY	dwg no		10030581	Rev.
catalog no				CUSTOMER DRAWING		sheet 3 of 4	E

Tous droits strictement réservés. Reproduction ou communication à des tiers interdite sous quelque forme que ce soit sans autorisation écrite du propriétaire. Propriété de c FCI. Droits de reproduction FCI.



All rights strictly reserved. Reproduction or issue to third parties in any form whatever is not permitted without written authority from the proprietor Property of FCI. Copyright FCI.

PRODUCT NO.  
10030581-3X0LF

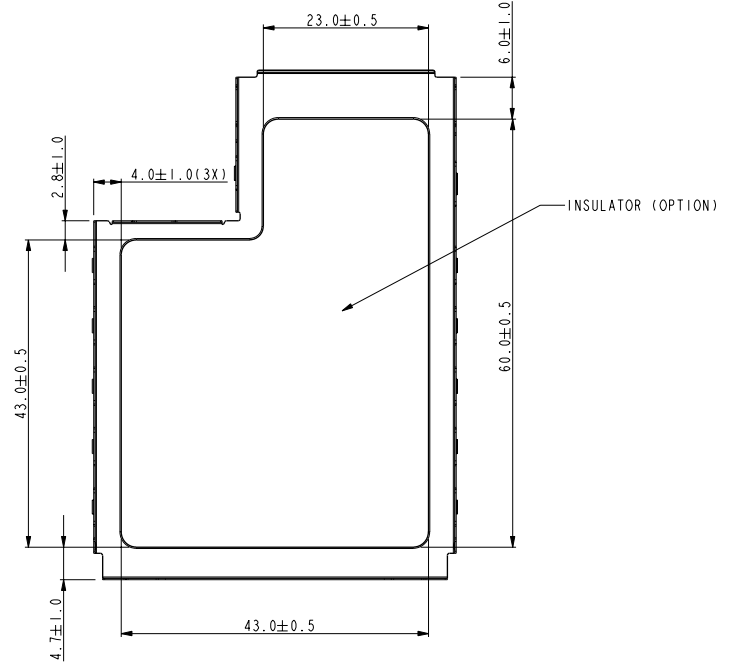
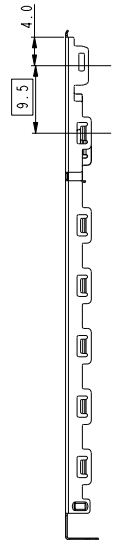
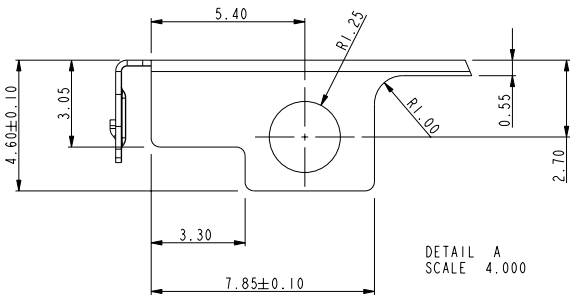
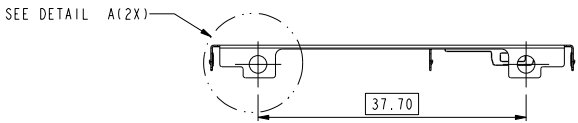
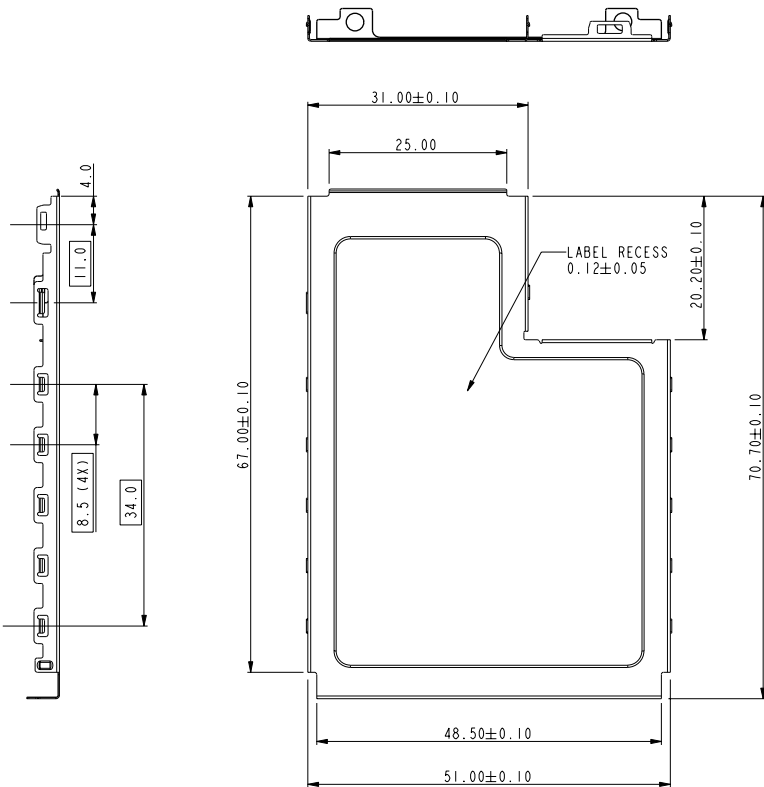

tolerance unless otherwise specified	
linear	.X ± .30
	.XX ± .15
	.XXX ± .08
angles	X° ± 2°

Dr	DAVID TENG	11/08/05	Product family	✓	tolerance	projection	size	Scale
	DAVID TENG	01/16/06	Spec ref	*		MM	A4	1.000
Chr	PAUL WANG	01/16/06	Material	*	ECN	*		
Appr	JOSEPH HSIA	01/16/06						
Title		EXPRESSCARS/54 MODULE CARD KIT TOP SHIELD SUB-ASSEMBLY		dwg no		10030581		Rev.
catalog no		CUSTOMER DRAWING		sheet 4 of 4				E