

Jun.1.2020 Copyright 2020 HIROSE ELECTRIC CO., LTD. All Rights Reserved.
 In case of consideration for using Automotive equipment / device which demand high reliability, kindly contact our sales window correspondents.

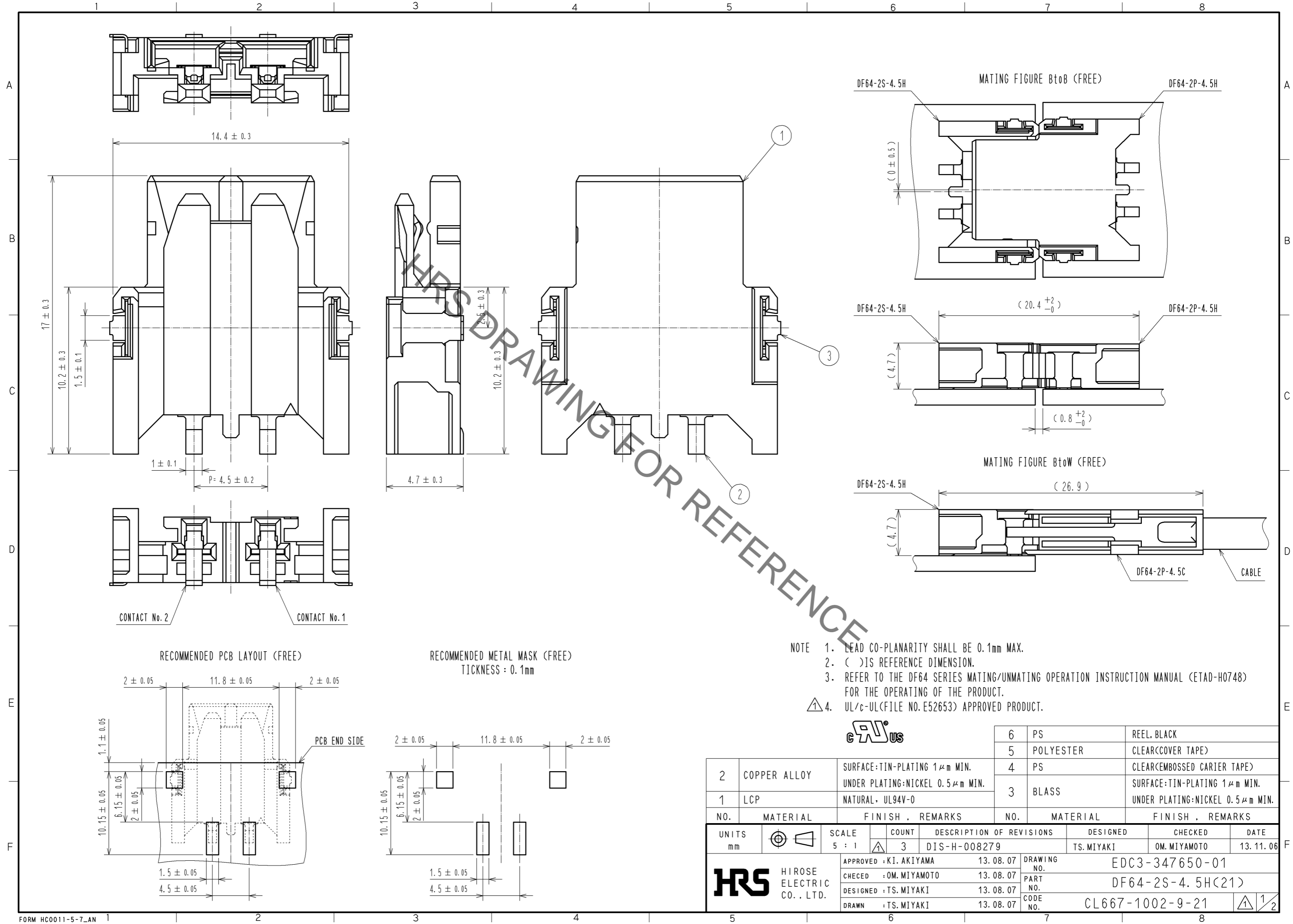

- NOTE
- LEAD CO-PLANARITY SHALL BE 0.1mm MAX.
 - () IS REFERENCE DIMENSION.
 - REFER TO THE DF64 SERIES MATING/UNMATING OPERATION INSTRUCTION MANUAL (ETAD-H0748) FOR THE OPERATING OF THE PRODUCT.
 - UL/c-UL(FILE NO. E52653) APPROVED PRODUCT.



2	COPPER ALLOY	SURFACE:TIN-PLATING 1μm MIN. UNDER PLATING:NICKEL 0.5μm MIN.	6	PS	REEL, BLACK
1	LCP	NATURAL, UL94V-0	5	POLYESTER	CLEAR(COVER TAPE)
			4	PS	CLEAR(EMBOSSED CARRIER TAPE)
			3	BLASS	SURFACE:TIN-PLATING 1μm MIN. UNDER PLATING:NICKEL 0.5μm MIN.
NO.	MATERIAL	FINISH . REMARKS	NO.	MATERIAL	FINISH . REMARKS
UNITS mm		SCALE 5 : 1	COUNT 3	DESCRIPTION OF REVISIONS	
				DESIGNED TS.MIYAKI	CHECKED OM.MIYAMOTO
				DATE 13.11.06	
HRS HIROSE ELECTRIC CO., LTD.		APPROVED : KI. AKIYAMA 13.08.07	DRAWING NO. EDC3-347650-01		
		CHECED : OM. MIYAMOTO 13.08.07	PART NO. DF64-2S-4.5H(21)		
		DESIGNED : TS. MIYAKI 13.08.07	CODE NO. CL667-1002-9-21		
		DRAWN : TS. MIYAKI 13.08.07	1/2		

Jun.1.2020 Copyright 2020 HIROSE ELECTRIC CO., LTD. All Rights Reserved.
 In case of consideration for using Automotive equipment / device which demand high reliability, kindly contact our sales window correspondents.

DRAWING FOR PACKING (2:1)

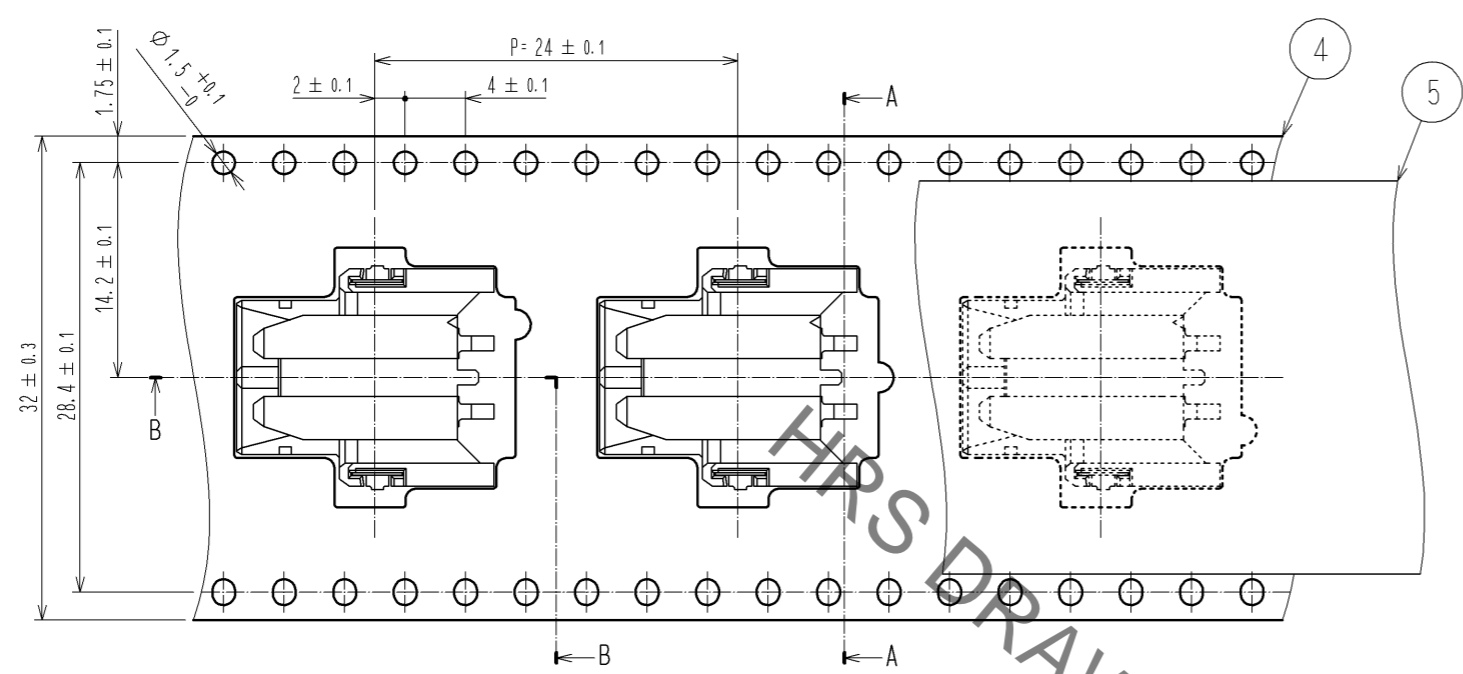

A-A(2:1)

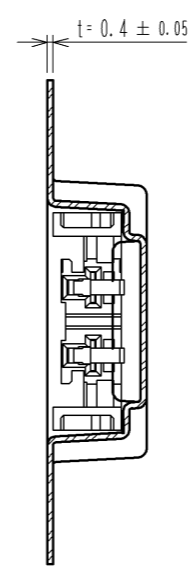

STYLE AND DIMENSION OF REEL(FREE)

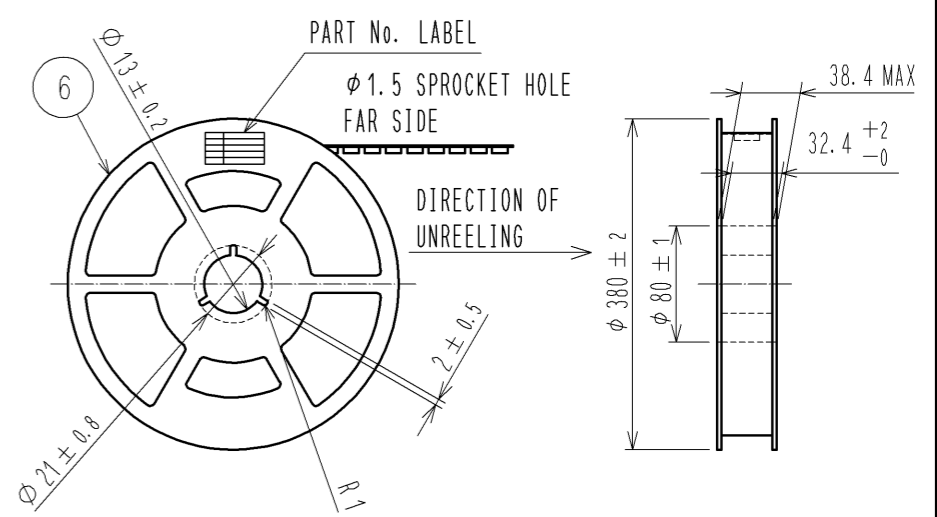

DETAIL OF PART No. LABEL

生産月日	年 月 日
図 番	CL667-1002-9-21
品 名	DF64-2S-4.5H(21)
納入数量	500 K0
納入者	ヒロセ電機(株)

B-B(2:1)

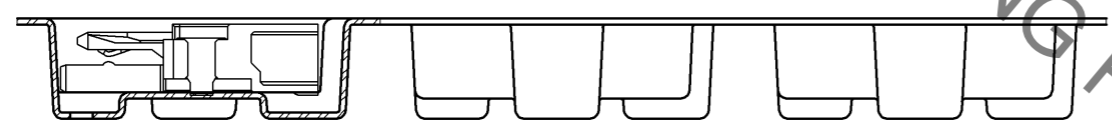

DIRECTION OF REELING →

REFLOW TEMPERATURE PROFILE USING LEAD-FREE SOLDER PASTE (REFERENCE)

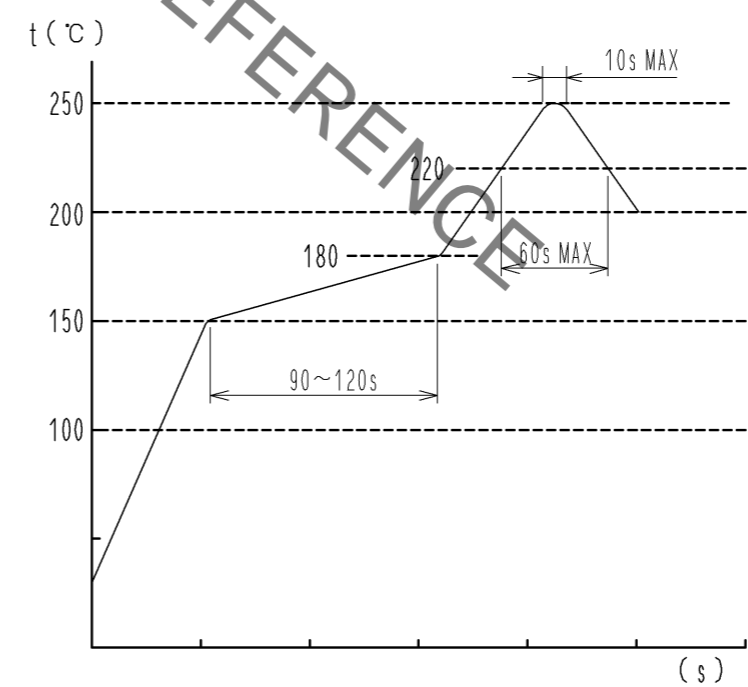

NUMBER OF REFLOW CYCLES 2 CYCLES MAX
 THE TEMPERATURE IS MEASURED IN THE TERMINAL LEAD PART.
 ADDITIONAL FACTORS, SUCH AS SOLDER PASTE TYPE,
 PCB SIZE AND OTHER MOUNTED COMPONENTS COULD AFFECT
 THE PROFILE.
 THEREFORE, A THOROUGH EVALUATION OF MOUNTING CONDITION IS
 REQUIRED PRIOR TO PRODUCTION.
 TEMPERATURE IS MEASURED AT CONTACT LEAD.

TAPING(FREE)

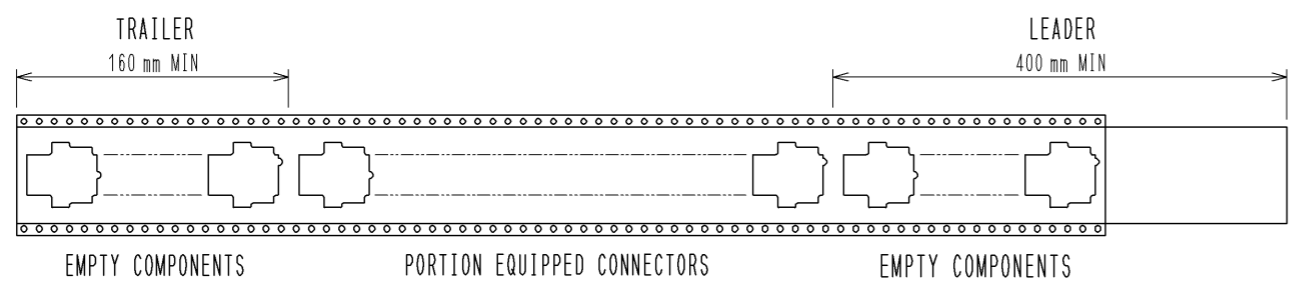

- NOTE 5. 1REEL:500 CONNECTORS.
- 6 REEL TO JIS C 0806.(PACKAGING OF COMPONENTS FOR AUTOMATING HANDLING)
- 7. () IS REFERENCE DIMENSION.

HRS	DRAWING NO.	EDC3-347650-01
	PART NO.	DF64-2S-4.5H(21)
	CODE NO.	CL667-1002-9-21
		2/2