

May.1.2020 Copyright 2020 HIROSE ELECTRIC CO., LTD. All Rights Reserved.
In case of consideration for using Automotive equipment / device which demand high reliability, kindly contact our sales window correspondents.

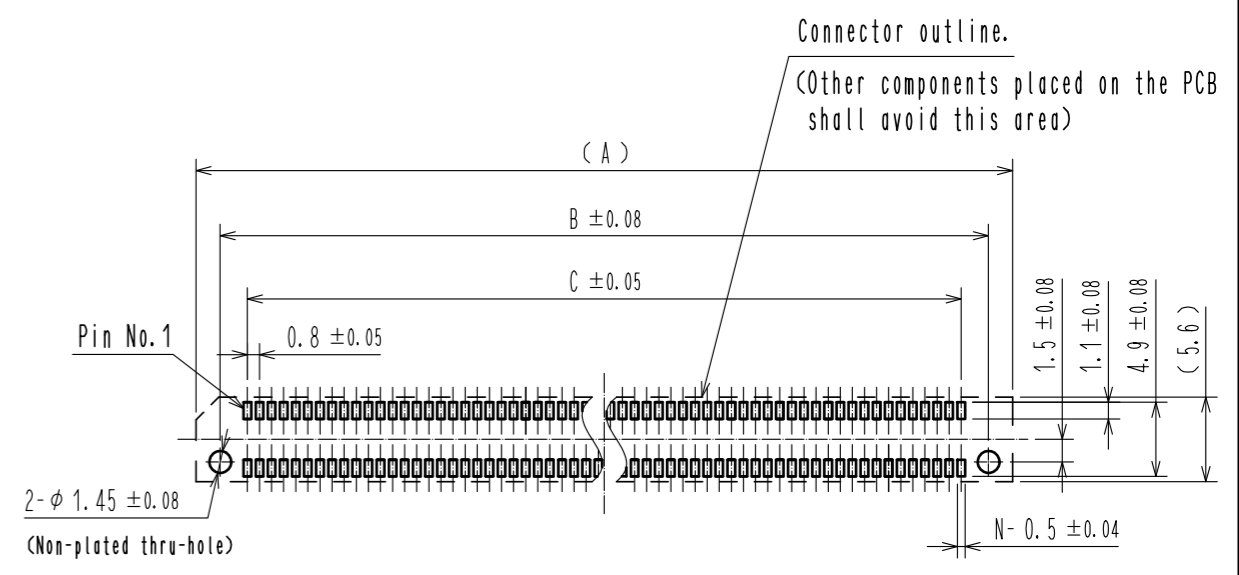
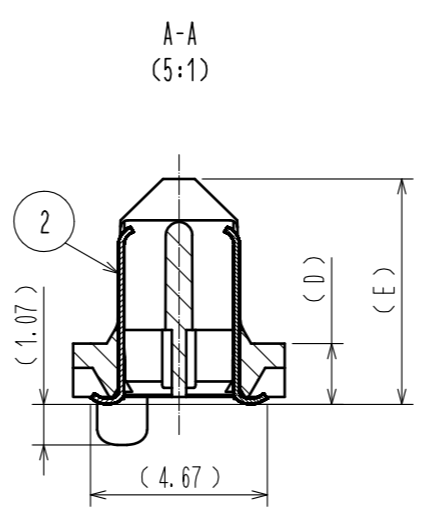
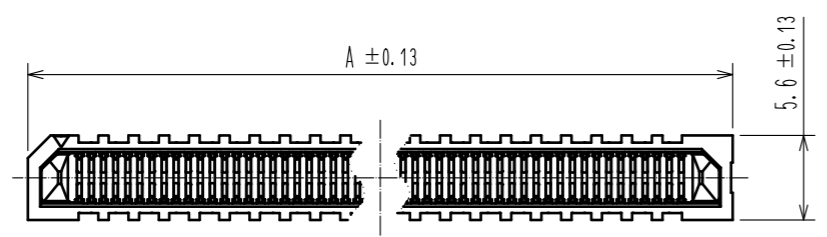

Fig.1 Recommended PCB Layout
(All dimensions are symmetric about the centerline)

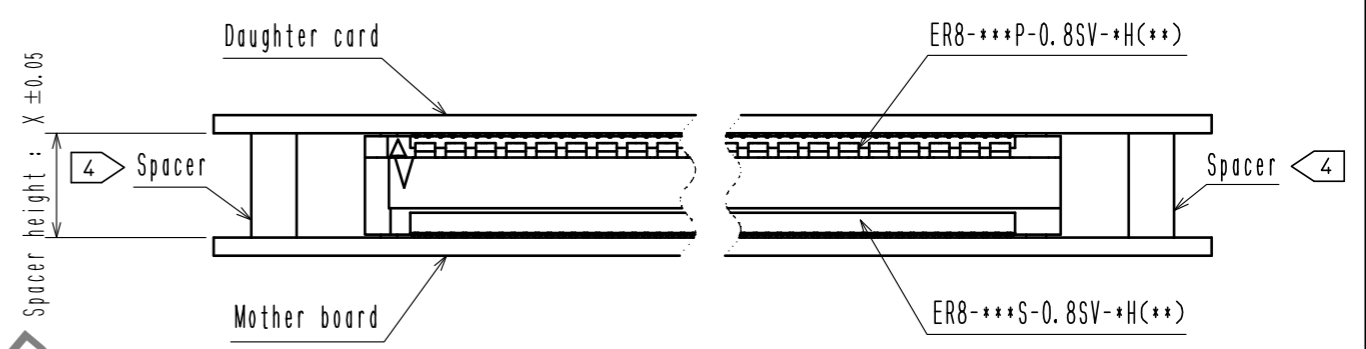
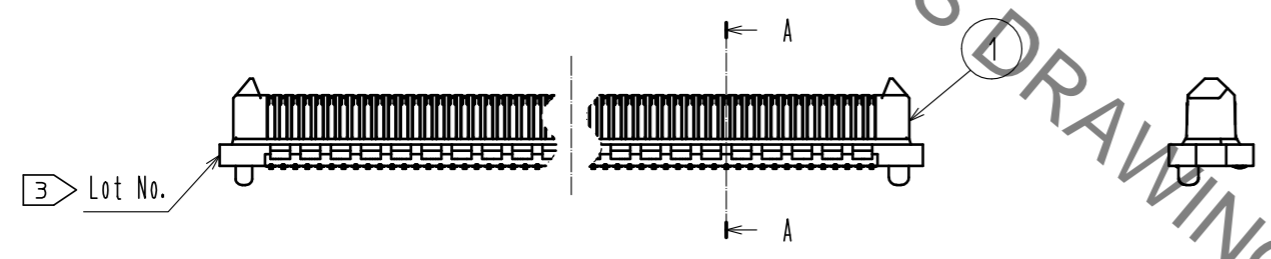
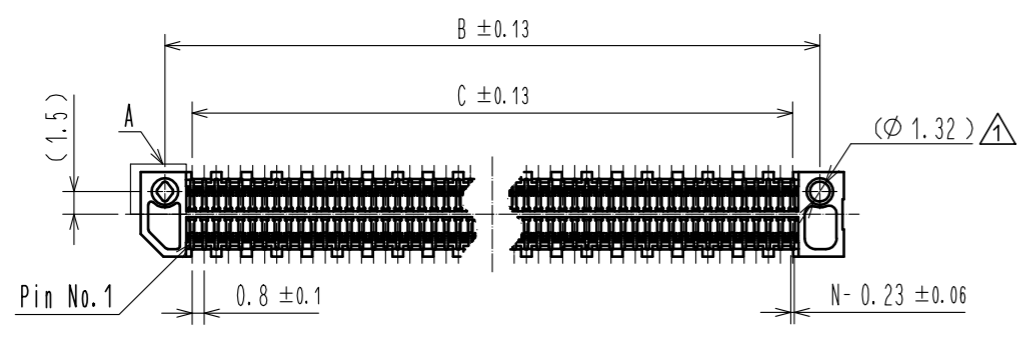

Fig.2 (Free)



Plug	Receptacle	Spacer height (X)
ER8-***P-0.8SV-2H(**)	ER8-***S-0.8SV-5H(**)	7.15
	ER8-***S-0.8SV-7H(**)	9.15
ER8-***P-0.8SV-5H(**)	ER8-***S-0.8SV-5H(**)	10.15
	ER8-***S-0.8SV-7H(**)	12.15

Table1 Spacer height

- Note.
- Dimensions in parentheses () are for reference.
 - Packaging for this product applies embossed carrier tape packaging. See sheet 2/3 and 3/3 for details.
 - Lot No. shall be marked on the indicated position.
 - The indicated mother board and daughter card shall be gastenedto the additional reinforcements to prevent the stress on ER8-***P-0.8SV-*(H)** and ER8-***S-0.8SV-*(H)**.
 - Plating specification are below.

Part No.	Plating specification
ER8-***P-0.8SV-*(H)	CONTACT AREA : Ni2.54μm + Au0.76μm
	LEAD AREA : Ni1.25μm + Sn3.81μm
ER8-***P-0.8SV-*(H)(10)	CONTACT AREA : Ni1.25μm + Au0.25μm
	LEAD AREA : Ni1.25μm + Sn2.54μm

NO.	MATERIAL	FINISH	REMARKS	NO.	MATERIAL	FINISH	REMARKS
3	POLYIMIDE		(TAPE FOR VACCUM PICK AND PLACE)	5	PE		(TOP COVER TAPE)
2	COPPER ALLOY			4	PS		(EMBOSSED CARRIER TAPE)
1	LCP		BLACK. UL94V-0				

UNITS	SCALE	COUNT	DESCRIPTION OF REVISIONS	DESIGNED	CHECKED	DATE
mm	2 : 1	2	DIS-F-00002236	TF. SUGAWARA	MK. EZAKI	17. 03. 25

APPROVED	CHECKED	DESIGNED	DRAWN	DRAWING NO.	PART NO.	CODE NO.
MK. EZAKI	MK. NAGATA	TF. SUGAWARA	TF. SUGAWARA	EDC-371040-00-00	ER8-***P-0.8SV-*(H)**	CL625

May.1.2020 Copyright 2020 HIROSE ELECTRIC CO., LTD. All Rights Reserved.
 In case of consideration for using Automotive equipment / device which demand high reliability, kindly contact our sales window correspondents.

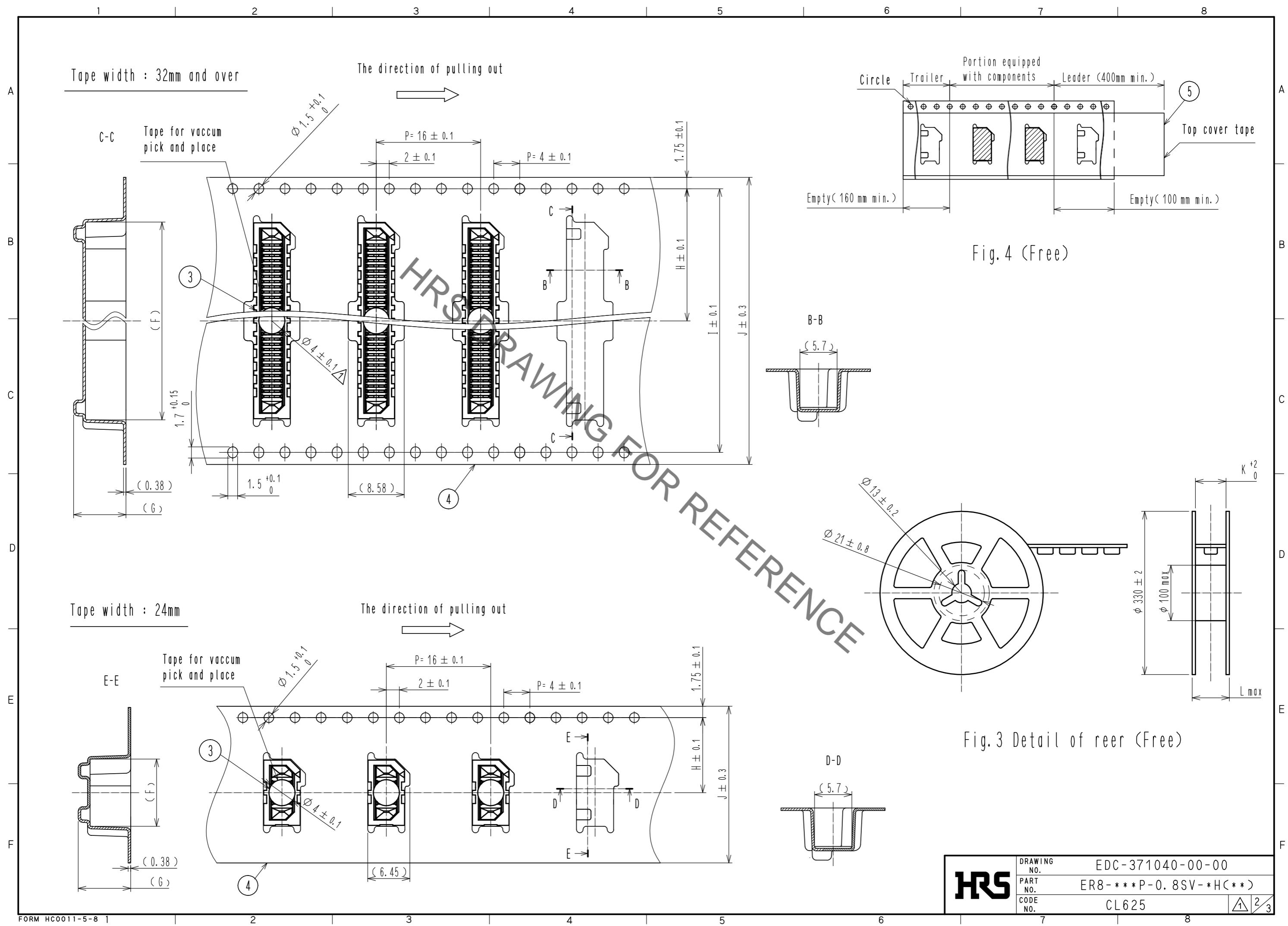

May.1.2020 Copyright 2020 HIROSE ELECTRIC CO., LTD. All Rights Reserved.
In case of consideration for using Automotive equipment / device which demand high reliability, kindly contact our sales window correspondents.

Part No.	Code No.	Contact positions (N)	Dimensions												Co-planarity	Qty/reel
			A	B	C	D	E	F	G	H	I	J	K	L		
ER8-10P-0.8SV-2H(**)	CL625-0008-8-**-	10	10	6.8	3.2	1.605	5.965	10.3	8.03	11.5	-	24	24.4	30.4	0.1 Max	450
ER8-20P-0.8SV-2H(**)	CL625-0011-0-**-	20	14	10.8	7.2	1.605	5.965	14.3	8.03	14.2	28.4	32	32.4	38.4	0.1 Max	475
ER8-30P-0.8SV-2H(**)	CL625-0012-0-**-	30	18	14.8	11.2	1.605	5.965	18.3	8.03	20.2	40.4	44	44.4	50.4	0.1 Max	475
ER8-40P-0.8SV-2H(**)	CL625-0013-0-**-	40	22	18.8	15.2	1.605	5.965	22.3	8.03	20.2	40.4	44	44.4	50.4	0.1 Max	350
ER8-50P-0.8SV-2H(**)	CL625-0009-0-**-	50	26	22.8	19.2	1.605	5.965	26.3	8.03	20.2	40.4	44	44.4	50.4	0.1 Max	350
ER8-60P-0.8SV-2H(**)	CL625-0017-0-**-	60	30	26.8	23.2	1.605	5.965	30.3	8.03	20.2	40.4	44	44.4	50.4	0.1 Max	350
ER8-70P-0.8SV-2H(**)	CL625-0021-0-**-	70	34	30.8	27.2	1.605	5.965	34.3	8.03	26.2	52.4	56	56.4	62.4	0.1 Max	350
ER8-80P-0.8SV-2H(**)	CL625-0022-0-**-	80	38	34.8	31.2	1.605	5.965	38.3	8.03	26.2	52.4	56	56.4	62.4	0.12 Max	350
ER8-100P-0.8SV-2H(**)	CL625-0023-0-**-	100	46	42.8	39.2	1.605	5.965	46.3	8.03	34.2	68.4	72	72.4	89	0.12 Max	350
ER8-120P-0.8SV-2H(**)	CL625-0003-4-**-	120	54	50.8	47.2	1.605	5.965	54.3	8.03	34.2	68.4	72	72.4	89	0.12 Max	375
ER8-10P-0.8SV-5H(**)	CL625-0024-0-**-	10	10	6.8	3.2	4.605	8.905	10.3	11	11.5	-	24	24.4	30.4	0.1 Max	325
ER8-20P-0.8SV-5H(**)	CL625-0025-0-**-	20	14	10.8	7.2	4.605	8.905	14.3	11	14.2	28.4	32	32.4	38.4	0.1 Max	325
ER8-30P-0.8SV-5H(**)	CL625-0026-0-**-	30	18	14.8	11.2	4.605	8.905	18.3	11	20.2	40.4	44	44.4	50.4	0.1 Max	325
ER8-40P-0.8SV-5H(**)	CL625-0020-0-**-	40	22	18.8	15.2	4.605	8.905	22.3	11	20.2	40.4	44	44.4	50.4	0.1 Max	250
ER8-50P-0.8SV-5H(**)	CL625-0027-0-**-	50	26	22.8	19.2	4.605	8.905	26.3	11	20.2	40.4	44	44.4	50.4	0.1 Max	250
ER8-60P-0.8SV-5H(**)	CL625-0019-0-**-	60	30	26.8	23.2	4.605	8.905	30.3	11	26.2	52.4	56	56.4	62.4	0.1 Max	250
ER8-70P-0.8SV-5H(**)	CL625-0028-0-**-	70	34	30.8	27.2	4.605	8.905	34.3	11	26.2	52.4	56	56.4	62.4	0.1 Max	250
ER8-80P-0.8SV-5H(**)	CL625-0029-0-**-	80	38	34.8	31.2	4.605	8.905	38.3	11	26.2	52.4	56	56.4	62.4	0.12 Max	250
ER8-100P-0.8SV-5H(**)	CL625-0030-0-**-	100	46	42.8	39.2	4.605	8.905	46.3	11	34.2	68.4	72	72.4	89	0.12 Max	250
ER8-120P-0.8SV-5H(**)	CL625-0031-0-**-	120	54	50.8	47.2	4.605	8.905	54.3	11	34.2	68.4	72	72.4	89	0.12 Max	250

Table2 Dimensions

HRS	DRAWING NO.	EDC-371040-00-00
	PART NO.	ER8-***P-0.8SV-*H(**)
	CODE NO.	CL625
		3/3